

WGF8N80S

Features:

- Low Intrinsic Capacitances.
- Excellent Switching Characteristics.
- Extended Safe Operating Area.
- Unrivalled Gate Charge :Qg=34nC (Typ.).
- VDSS= 800V, ID=7A
- R_{DS(on)} : 1.8Ω (Max) @V_G=10V
- 100% Avalanche Tested

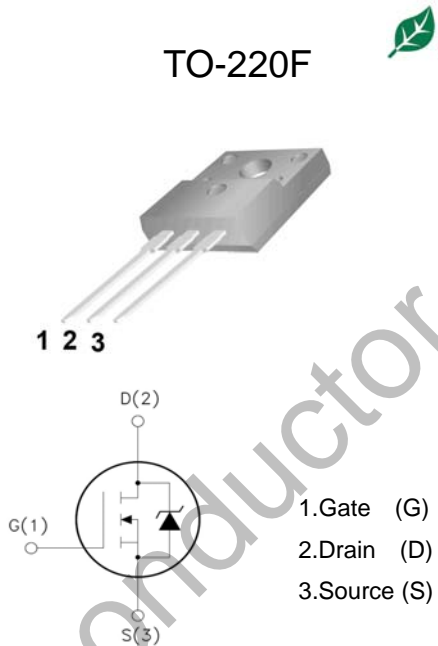

TO-220F

RoHS COMPLIANT

1.Gate (G)
2.Drain (D)
3.Source (S)

Absolute Maximum Ratings (Ta=25°C unless otherwise noted)

Symbol	Parameter	Value	Unit
V _{DSS}	Drain-Source Voltage	800	V
I _D	Drain Current	T _j =25°C	8.0
		T _j =100°C	4.4
V _{GSS}		±30	V
E _{AS}	Single Pulse Avalanche Energy (note1)	150	mJ
I _{AR}	Avalanche Current (note2)	7.0	A
P _D	Power Dissipation (T _j =25°C)	48	W
T _j	Junction Temperature(Max)	150	°C
T _{stg}	Storage Temperature	-55~+150	°C
TL	Maximum lead temperature for soldering purpose, 1/8" from case for 5 seconds	300	°C

Thermal Characteristics

Symbol	Parameter	Typ.	Max.	Unit
R _{θJC}	Thermal Resistance, Junction to Case	-	2.6	°C/W
R _{θJA}	Thermal Resistance, Junction to Ambient	-	62.5	°C/W

Electrical Characteristics (Ta=25°C unless otherwise noted)

Symbol	Parameter	Test Condition	Min.	Typ.	Max.	Unit
Off Characteristics						
BV _{DSS}	Drain-Source Breakdown Voltage	I _D =250μA, V _{GS} =0	800	-	-	V
ΔBV _{DSS} /ΔT _J	Breakdown Voltage Temperature Coefficient	I _D =250μA, Reference to 25°C	-	0.67	-	V/°C
I _{DSS}	Zero Gate Voltage Drain Current	V _{DS} =800V, V _{GS} =0V	-	-	10	μA
		V _{DS} =640V, T _J =125°C	-	-	100	
I _{GSSF}	Gate-body leakage Current, Forward	V _{GS} =+30V, V _{DS} =0V	-	-	100	nA
I _{GSSR}	Gate-body leakage Current, Reverse	V _{GS} =-30V, V _{DS} =0V	-	-	-100	
On Characteristics						
V _{GS(TH)}	Date Threshold Voltage	I _D =250μA, V _{DS} =V _{GS}	2	-	4	V
R _{DS(ON)}	Static Drain-Source On-Resistance	I _D =3.5A, V _{GS} =10V	-	1.5	1.8	Ω
Dynamic Characteristics						
C _{iss}	Input Capacitance	V _{DS} =25V, V _{GS} =0, f=1.0MHz	-	1350	-	pF
C _{oss}	Output Capacitance		-	115	-	
C _{rss}	Reverse Transfer Capacitance		-	12	-	
Switching Characteristics						
T _{d(on)}	Turn-On Delay Time	V _{DD} =400V, I _D =7A R _G =12Ω	-	15	-	ns
T _r	Turn-On Rise Time		-	25	-	
T _{d(off)}	Turn-Off Delay Time		-	51	-	
T _f	Turn-Off Rise Time		-	31	-	
Q _g	Total Gate Charge	V _{DS} =400V, V _{GS} =10V, I _D =7A	-	34	-	nC
Q _{gs}	Gate-Source Charge		-	6.0	-	
Q _{gd}	Gate-Drain Charge		-	14	-	
Drain-Source Diode Characteristics and Maximum Ratings						
I _S	Max. Diode Forward Current	-	-	-	8	A
I _{SM}	Max. Pulsed Forward Current	-	-	-	28	
V _{SD}	Diode Forward Voltage	I _D =7A	-	-	1.5	V
T _{rr}	Reverse Recovery Time	I _S =7A, V _{GS} =0V diF/dt=100A/μs	-	186	-	nS
Q _{rr}	Reverse Recovery Charge	(Note3)	-	878	-	μC

Notes : 1, L=25.0mH, I_{AS}=7A, V_{DD}=50V, R_G=25Ω, Starting T_J =25°C

2, Repetitive Rating : Pulse width limited by maximum junction temperature

3, Pulse Test : Pulse Width ≤ 300μs, Duty Cycle ≤ 2%

4, Essentially Independent of Operating Temperature

Typical Characteristics

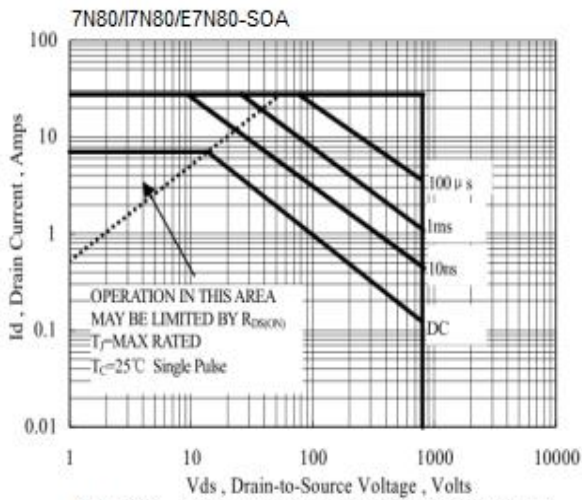

Figure 1a Maximum Forward Bias Safe Operating Area

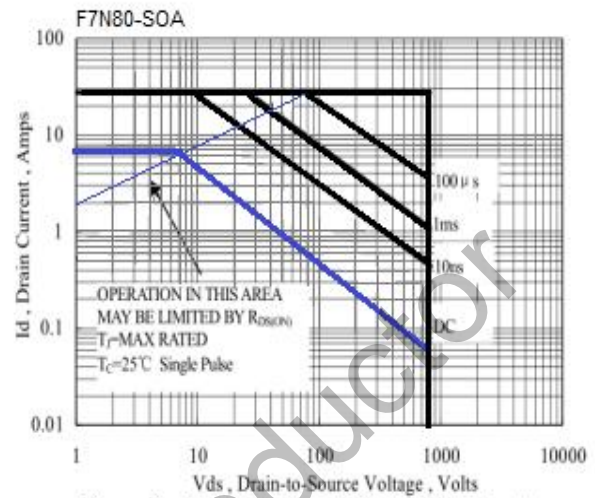

Figure 1b Maximum Forward Bias Safe Operating Area

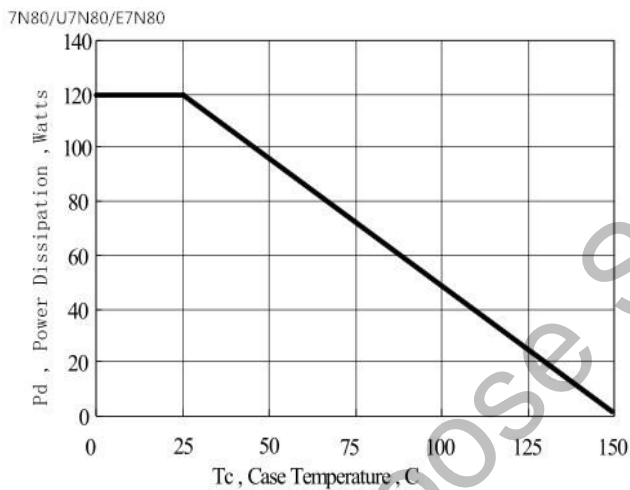

Figure.2(a) Maximum Power Dissipation VS Case Temperature

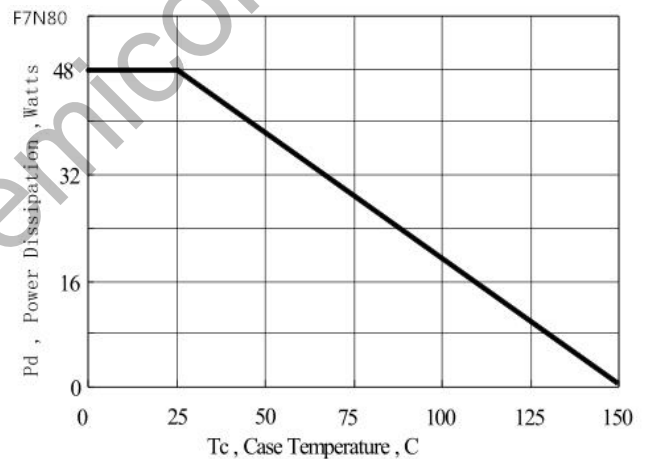

Figure.2(b) Maximum Power Dissipation VS Case Temperature

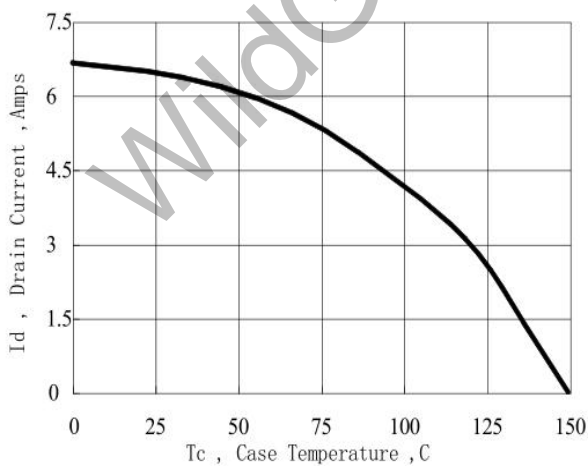

Figure 3 Maximum Continuous Drain Current vs Case Temperature

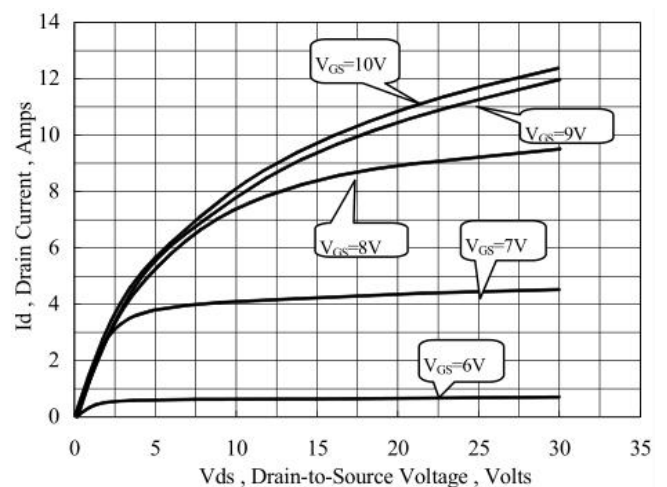
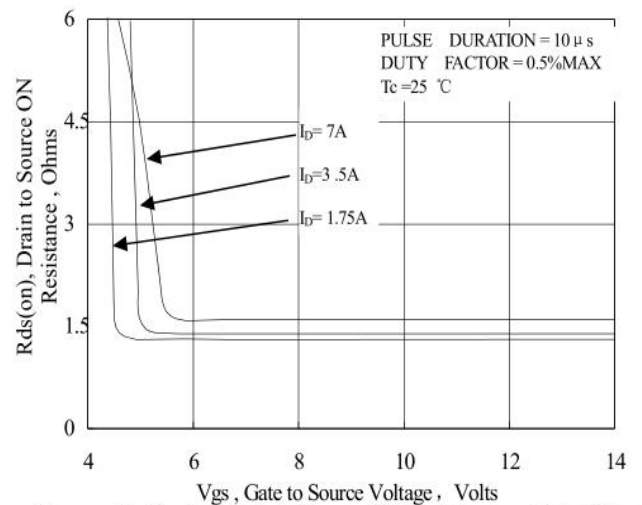
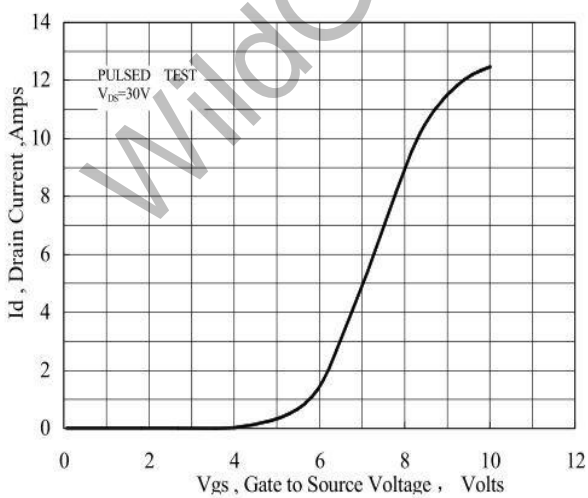
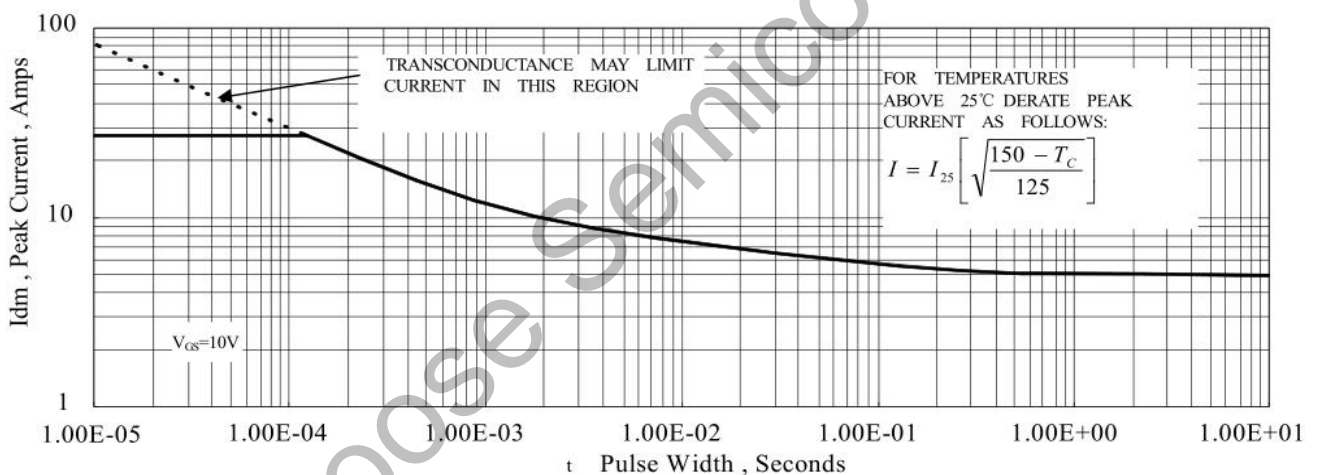
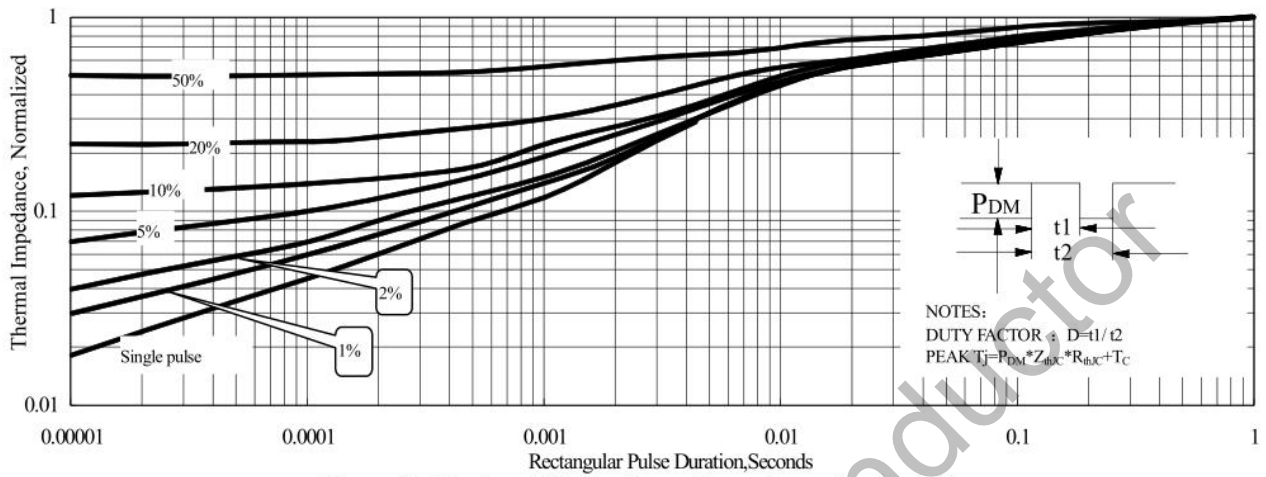
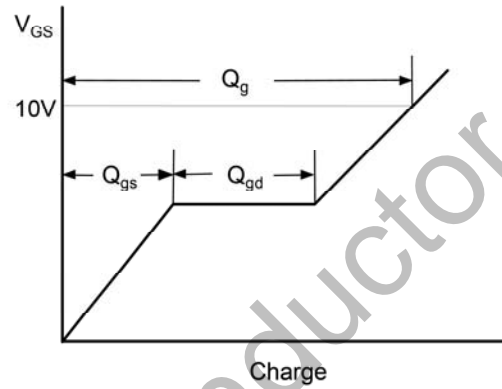
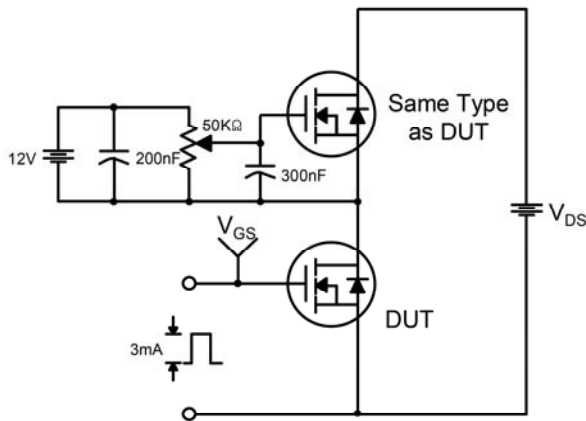

Figure 4 Typical Output Characteristics

Typical Characteristics (Continued)



Gate Charge Test Circuit & Waveform



Resistive Switching Test Circuit & Waveforms

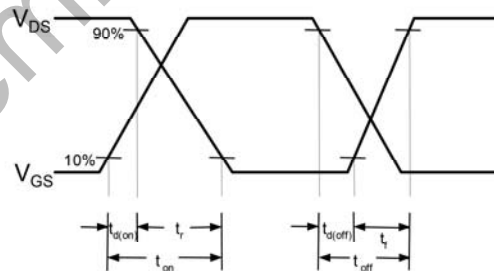
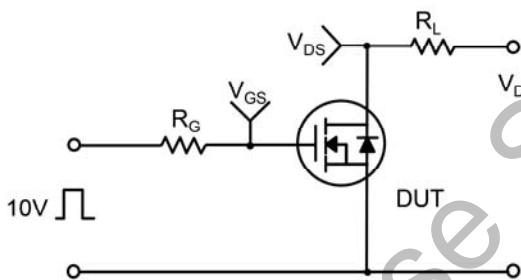

Unclamped Inductive Switching Test Circuit & Waveforms

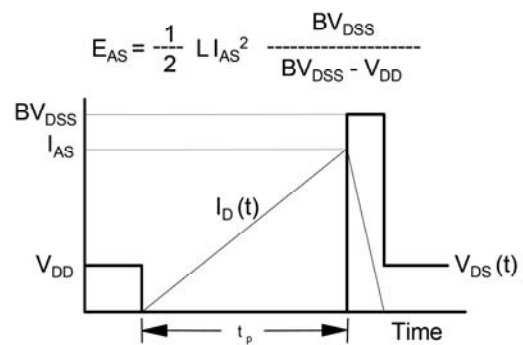
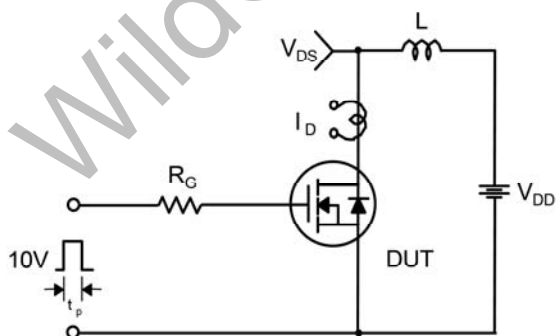

Peak Diode Recovery dv/dt Test Circuit & Waveform

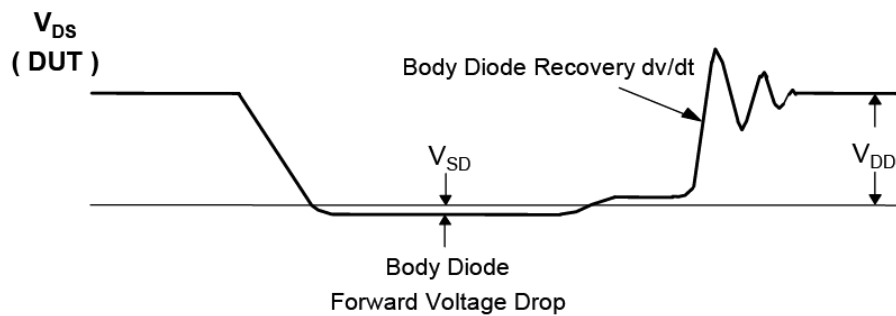
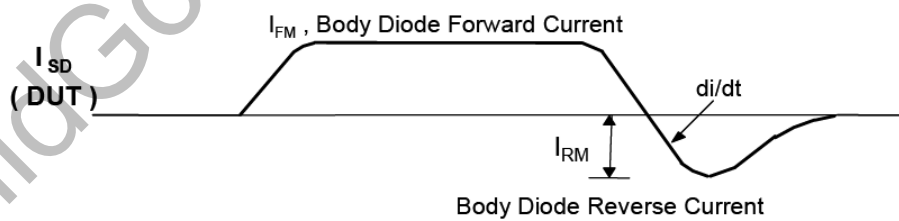
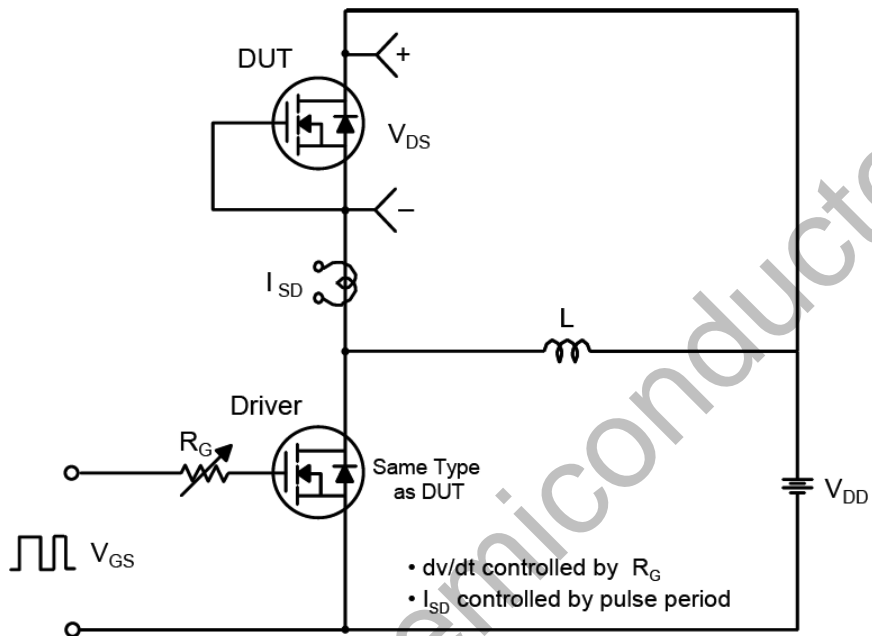

Package Dimension

TO-220F

Unit: mm

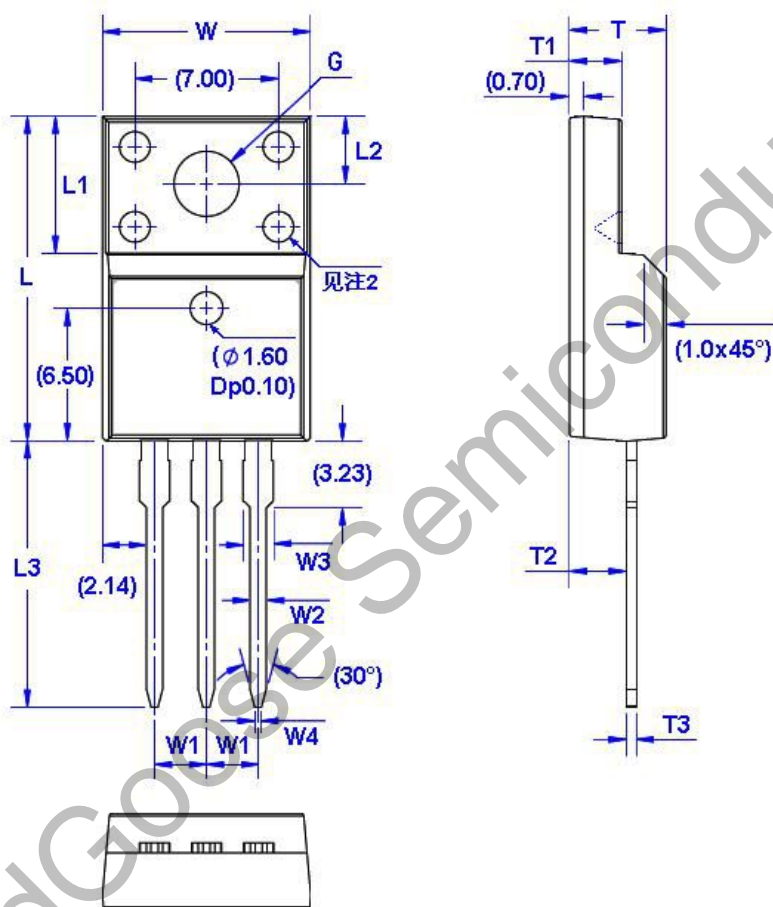

Symbol	Size		Symbol	Size		Symbol	Size		Symbol	Size	
	Min	Max		Min	Max		Min	Max		Min	Max
W	9.96	10.36	W4	0.25	0.45	L3	12.78	13.18	T3	0.45	0.60
W1	2.54 (TYP)		L	15.67	16.07	T	4.50	4.90	G(Φ)	3.08	3.28
W2	0.70	0.90	L1	6.48	6.88	T1	2.34	2.74			
W3	1.24	1.47	L2	3.20	3.40	T2	2.56	2.96			