

SECTION A-A'

- NOTES
1. FREQUENCY RANGE:  
DC TO 6GHZ (VSWR: 1.3MAX AT 0.1~3GHZ, 1.4MAX AT 3~6GHZ)
  2. CHARACTERISTIC IMPEDANCE: 50Ω (NOMINAL)
  3. TEMPERATURE: 60VAC;
  4. RATED VOLTAGE: 60VAC;
  5. CONTACT RESISTANCE:  
20Ω MAX.(SIGNAL CONTACT)  
20Ω MAX.(GROUND CONTACT)
  6. WITHSTAND VOLTAGE: 200VAC FOR 1MINUTE MIN;
  7. INSULATION RESISTANCE: 500Ω MIN. AT 100VDC;
  8. THIS COMPONENT IS HALOGEN FREE.

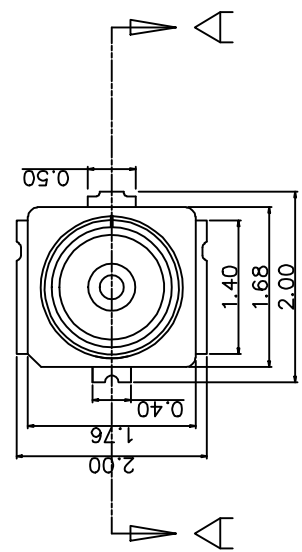
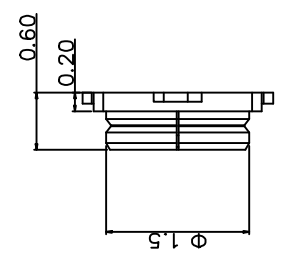

ITEM	QTY	MATERIAL	FINISH	REMARK
3	1	COPPER ALLOY	Ni500~1000'/GOLD FLOSH	
2	1	COPPER ALLOY	Ni500~1000'/GOLD FLOSH	
1	1	COPPER ALLOY	Ni500~1000'/GOLD FLOSH	

X.±	X.± 1'	UNITS	mm
.X± 0.25	.X±	MAT'L	
.XX± 0.25	.XX±	FINISH	
.XXX±	.XXX±	Q'TY	

		TITLE: IPEX4-TXZ 214	
PART NO.(INTENDED USE) CFP410B12		DWG NO.:	
APPD: 罗孝金		CHKD: 钟德华	
DR: 李春风		SCALE SHEET REV. 1:1 1/2 A	

REV	ECN NO.	APPD
A	ECN1209001	MAX



深圳市首韩科技有限公司

SHENZHEN SHOUHAN TECHNOLOGY CO., LTD

Tel: 0755-27597601 Fax: 0755-27597491

# 承 认 书

## SPECIFICATION FOR APPROVAL

客 户 Customer:

\_\_\_\_\_

产品名称 Project:

天线座

\_\_\_\_\_

规格型号 Part No:

IPEX4-TXZ 214

\_\_\_\_\_

### 贵公司承认印 Approval signatures

料 号/Part No.	签 章/Signatures

日期 Date:

拟制/Drawn	李春风	
审核/Check	钟华华	
批准/Approved	罗孝金	

## 1. 规格要求 Requirements:

### 1.1 应用条件 Application Condition:

#### 1.1.1 使用环境 Operating Environment:

温度:  $-40^{\circ}\text{C}$  to  $+90^{\circ}\text{C}$ ,相对湿度:25%~85%,此条件下功能不可失效。

Temperature:  $-40^{\circ}\text{C}$  to  $+90^{\circ}\text{C}$ , Relative Humidity:25%~85%, Without loss of function.

#### 1.1.2 储存环境 Storage Environment:

温度:  $-55^{\circ}\text{C}$  to  $+100^{\circ}\text{C}$ ,相对湿度:95%或更低,此条件下功能不可失效。

Temperature:  $-55^{\circ}\text{C}$  to  $+100^{\circ}\text{C}$ , Relative Humidity: 95% or Less, Without loss of function.

#### 1.1.3 额定值 Ratings:

A. 额定电压 Voltage Rating: 60VAC

B. 公称特性 Nominal characteristic impedance:50 $\Omega$

C. 周波数 Frequency:DC0.1~6GHz

D. VSWR: Plug 1.3Max.(DC0.1~3GHz),1.5Max.(3~6GHz)

Receptacle 1.3Max.(DC0.1~3GHz),1.4Max.(3~6GHz)

### 1.2 绿色环保要求 Health, Safety and Environment

此产品中所有涉及环保有关的有害物质管控标准请参考 SGS

Hazardous substances (Environment related to be controlled substances) contained in this product should comply with the regulations specified by SGS

### 1.3 测试说明 Test Description

此产品性能须满足本文件 3.4 节中的各项规格要求。除非有特别申明，所有的测试和量测必须在以下条件中进行:

The product is designed to meet the requirements specified in section 3.4. Unless otherwise specified, all tests and measurements are to be performed under the following conditions:

温度 Temperature: 15~35 $^{\circ}\text{C}$

相对湿度 Humidity: 45% ~ 75%

## 1.4 测试规范和方法 Test Requirements and Methods

**Table I: 性能要求 Performance Requirements**

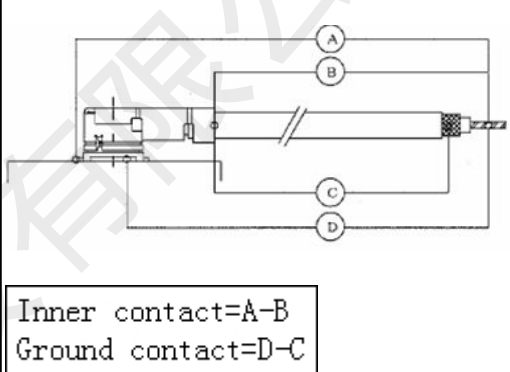
项目 Items	规格要求 Requirements	测试方法 Test Methods
1.4.1 产品外观  Visual Examination	所有零件必须组装完好, 不能出现毛边, 变形, 刮伤, 以及任何外观破坏等异常;  All components shall be properly assembled and free of burrs, warps, scratches, broken chips, and other abnormalities	参考测试标准: EIA 364-18B 依照相应的文件和规格书进行外观, 功能, 及尺寸的检验量测.  Comply with method EIA 364-18B Visual, functional, and dimensional inspection complies with applicable specification and document.
1.4.2 低功率接触阻抗  Low Level Contact Resistance	初值最大 20mΩ  20mΩ Max Initial  终值最大 70mΩ  70mΩ Max. Final.	
1.4.3 绝缘阻抗  Insulation Resistance	初期最小 500 MΩ  500 MΩ Min Initial  终期最小 100 MΩ  100 MΩ Min Final	参考测试标准: EIA-364-21D. 在相邻两支端子之间加 100V 直流电压并保持 1 分钟, 测出阻抗值.  Comply with method EIA-364-21D. Insulation resistance is measured between adjacent contacts after applying 100V DC for 1 minutes.
1.4.4 耐电压  Dielectric Withstanding Voltage	加电压期间漏电流不超过 0.5mA. 同时不能产生电弧以及而产生的短路和破坏产品的绝缘性能.  No evidence of breakdown or flash burn. No burn caused by short circuit. No insulation destruction. Current leakage: 0.50 mA Max.	参考测试标准: EIA-364-20D,方法 B; 在产品以及与之配对的 plug 之间加 2 00V 交流电压保持 1 分钟,监控漏电流.  Comply with method EIA-364-20D, Test Method B. apply 200V AC 1 minute at sea level on tested plug and connectors.
1.4.5 电压驻波比  VSWR	Plug 1.3 以下 0.1~3GHz,1.5 以下 3~6GHz Plug 1.3Max.at 0.1~3GHz,1.5 Max.at 3~6GHz Receptacle 1.3 以下0.1~3GHz,1.4 以下 3~6GHz Receptacle 1.3Max.at 0.1~3GHz, 1.4Max.at 3~6GHz.	周波数:100M~6GHz  Measure the VSWR as shown by the network analyzer.Frequency:100M~6GHz  

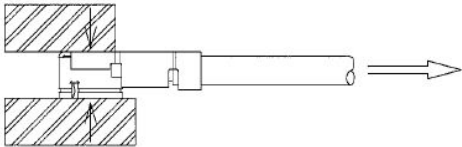
项目 Items	规格要求 Requirements	测试方法 Test Methods
1.4.6 拔去力  Un-mating force	综合拔去力:初回拔去力 5 N 以上, 30回后拔去力 3N 以上  Total un-mate force: Initial 5N Min. after 30 cycles 3N Min	插拔试验机以每分 25±3mm 的速度 进行插拔  Un-mate the receptacle  connector(soldered to the test board)and plug at a speed 25±3mm/minutes along the mating by the push-on/pull-off machine
1.4.7 引张强度  Crimp strength	5N 以上  5N MIN	通过引张试验机以每分 25+/-3 毫米/ 分钟的速度拉线材部分.  Pull the cable as shown at a speed 25+/-3mm/minutes by tensile strength machine.  
1.4.8 耐插拔  Durability	中心导体接触阻抗: 初期 20 mΩ, 以 下, 试验后 40 mΩ以下  Contact resistance of inner contact initial 20 milli-ohm MAX. after testing 40milli-ohm MAX.  外部导体接触阻抗: 初期 20 mΩ, 以下, 试验后 40 mΩ以下  Contact resistance of ground contact initial 20 mille-ohm MAX.after testing 40milli-ohm MAX.  外观无损伤  No abnormality	母头连接器焊接在板上以每分钟 25±3mm 的速度插拔 30 次  Mate and un-mate the receptacle connector (soldered to the test board)and plug 30 cycles at a speed 25±3mm/minutes along the mating by the push-on/pull-off machine.  参考测试标准: EIA-364-09C;
1.4.9	部品无外观及其它异常.	施加力于图 Fig.1 方向

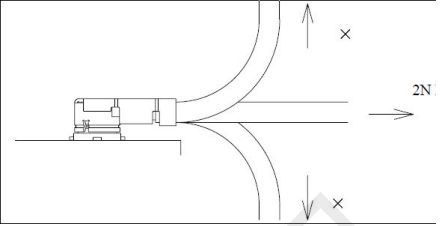
<p>线材保持力 Cable retention force</p>	<p>Appearance: Looseness between the parts, chipping, breakage or other abnormality shall not occur</p> <p>试验中无 1 微秒的电流中断</p> <p>Electrical discontinuity :No electrical discontinuity grater than 1 micro-sec. shall occur.</p> <p>中心导体接触阻抗: 初期 20 mΩ, 以下, 试验后 40 mΩ以下</p> <p>Contact resistance of inner contact initial 20 milli-ohm MAX. after testing 40milli-ohm MAX.</p> <p>外部导体接触阻抗: 初期 20 mΩ, 以下, 试验后 40 mΩ以下</p> <p>Contact resistance of ground contact initial 20 milli-ohm MAX. after testing 40milli-ohm MAX.</p>	<p>Apply force on the cable as shown</p>  <p>试验期间工作电流 100mA DC, 检查瞬间电流中断.</p> <p>During the testing, run 100mA DC to check electrical discontinuity.</p>
<p>1.4.10 振动 Vibration</p>	<p>外观无异常</p> <p>Apply the following vibration to the mating connector.</p> <p>试验中不得有超过 1 微秒的漏电流产生</p> <p>Electrical discontinuity: No electrical discontinuity grater than 1micro-sec. shall occur.</p> <p>中心导体接触阻抗: 初期 20 mΩ, 以下, 试验后 40mΩ以下</p> <p>Contact resistance of inner contact initial 20 milli-ohm MAX. after testing 40milli-ohm MAX.</p>	<p>嵌合状态下振动, 试检中电流瞬断的确认.</p> <p>Apply the following vibration to the mating connector.</p> <p>周波数: 10Hz-100Hz-10Hz 约 20 分</p> <p>Frequency: 10Hz-100Hz-10Hz/ approx 20 minutes.</p> <p>片振幅, 加速度: 1.5mm or 59m/s<sup>2</sup>(6G)</p> <p>Half amplitude, peak value of acceleration: 1.5mm or 59m/s<sup>2</sup>(6G)</p> <p>方向: 三个互相垂直的方向 3 次实施.</p> <p>Directions, cycle: 3 mutually</p>

	<p>外部导体接触阻抗: 初期 20 mΩ, 以下, 试验后 40 mΩ以下</p> <p>Contact resistance of ground</p> <p>contact initial 20 milli-ohm MAX. after testing 40milli-ohm MAX.</p>	<p>perpendicular direction,3 cycles for each direction.</p> <p>测试期间连接 100mA DC</p> <p>During the testing run 100mA DC</p> <p>参考测试标准: EIA-364-28E,</p>
<p>1.4.11 物理冲击 Physical shock</p>	<p>外观无异常</p> <p>Appearanec:Looseness between the parts, chipping, breakage or other abnormality shall not occur.</p> <p>不得有超过 1 微秒的漏电流产生.</p> <p>Electrical discontinuity: No electrical discontinuity grater than 1 micro-sec. shall occur.</p> <p>中心导体接触阻抗:初期 20 mΩ以下, 试验后 40 mΩ以下.</p> <p>Contact resistance of inner contact initial 20 milli-ohm MAX. after testing 40milli-ohm MAX.</p> <p>外部导体接触阻抗:初期 20 mΩ以下, 试验后 40 mΩ以下.</p> <p>Contact resistance of ground contact initial 20 milli-ohm MAX. after testing 40milli-ohm MAX.</p>	<p>嵌合状态在冲击试验机下冲击, 试验中 DC100mA 电流的瞬断确认。参考标准 EIA-364-27B.</p> <p>Apply the following vibration to the mating connector in accordance with MIL-STD-202, Method 213, Condition B. During the testing, run 100mA DC to check electrical</p> <p>最大加速度:735m/s<sup>2</sup>(75G)</p> <p>Peak value of acceleration:735m/s<sup>2</sup>(75G).</p> <p>Duration:11msec</p> <p>Wave Form: half sinusoidal</p> <p>Diretions,cycle:6 mutually perpendicular,3 cycles about each direction.</p> <p>参考测试标准: EIA-364-27B.</p>
<p>1.4.12 耐湿性 Humidity</p>	<p>部品无外观及其它异常</p> <p>Appearance: Looseness between the parts, chipping, breakage or other abnormality shall not occur.</p> <p>中心导体接触阻抗: 初期 20 mΩ, 以下, 试验后 40 mΩ以下</p> <p>Contact resistance of inner contact initial 20 milli-ohm MAX. after testing</p>	<p>嵌合状态的连接器在以下环境放置.</p> <p>Apply the following environment to the mating connector in accordance with</p> <p>温度:313+/-2K(40+/-2°)</p> <p>Temperature:313+/-2K(40+/-2°)</p> <p>湿度:90~95%RH</p> <p>Humidity:90~95%RH</p> <p>时间:96 小时</p>

	<p>40milli-ohm MAX.</p> <p>外部导体接触阻抗：初期 20 mΩ, 以下，试验后 40 mΩ以下</p> <p>Contact resistance of ground</p> <p>contact initial 20 mille-ohm</p> <p>MAX.after testing</p> <p>40milli-ohm MAX</p> <p>绝缘阻抗:初期 500MΩ 以上, 试验后 100MΩ以上.</p> <p>Insulation resistance: initial 500 mega-ohm MIN.after testing 100 mega-ohm MIN.</p> <p>耐电压:沿面放电,空中放电,绝缘破坏无异常发生.</p> <p>D.W.Voltage:No creeping</p> <p>discharge,flashover,nor insulator</p> <p>breakdown shall occur</p>	<p>Duration:96 hours</p> <p>参考测试标准：EIA-364-31C 中方法 II,条件 A;</p>
<p>1.4.13 热冲击 Thermal shock</p>	<p>部品无外观及其它异常</p> <p>Appearance: Looseness between the parts, chipping, breakage or other abnormality shall not occur.</p> <p>中心导体接触阻抗：初期 20 mΩ, 以下，试验后 40 mΩ以下</p> <p>Contact resistance of inner</p> <p>contact initial 20 milli-ohm</p> <p>MAX.after testing</p> <p>40milli-ohm MAX.</p> <p>外部导体接触阻抗：初期 20 mΩ, 以下，试验后 40 mΩ以下</p> <p>Contact resistance of ground</p> <p>contact initial 20 mille-ohm</p> <p>MAX. after testing 40milli-ohm MAX</p> <p>绝缘阻抗:初期 500MΩ 以上, 试验后</p>	<p>嵌合状态的连接器在以下环境</p> <p>Apply the following environment to the mating connector.</p> <p>温度 Temperature:</p> <p>218K(-55°C) :30 min. ←→ 358K(85°C): min.</p> <p>移动时间 Transition time:</p> <p>5 min. Max.</p> <p>回数 No.of cycles:</p> <p>5 cycles</p> <p>参考测试标准：EIA-364-32E;</p>



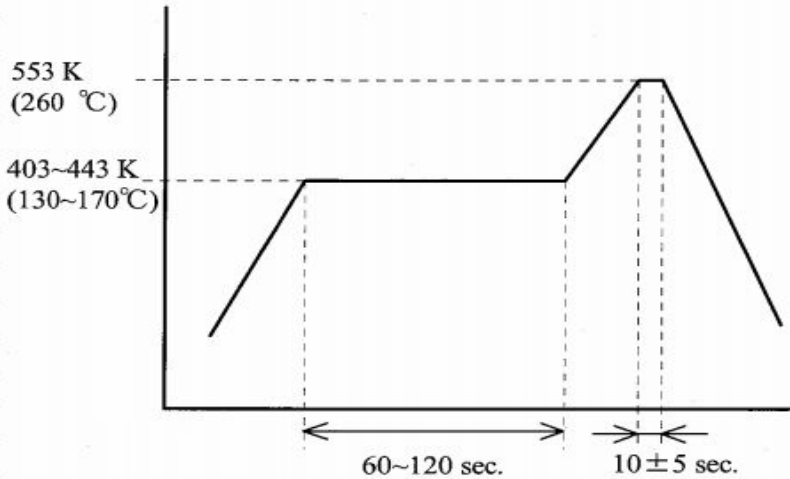

	<p>100MΩ以上.</p> <p>Insulation resistance: initial 500 mega-ohm MIN.after testing 100 mega-ohm MIN.</p> <p>耐电压:沿面放电,空中放电,绝缘破坏无异常发生.</p> <p>D.W.Voltage:No creeping</p> <p>discharge,flashover,nor insulator</p> <p>breakdown shall occur</p>	
<p>1.4.14 高温寿命 Temperature Life</p>	<p>部品无外观及其它异常</p> <p>Appearance: Looseness between the parts, chipping breakage or other abnormality shall not occur</p> <p>中心导体接触阻抗: 初期 20 mΩ, 以下, 试验后 40 mΩ以下</p> <p>Contact resistance of inner contact initial 20 milli-ohm MAX.after testing 40milli-ohm MAX</p> <p>外部导体接触阻抗:初期 20 mΩ以下,试验后 40 mΩ以下..</p> <p>Contact resistance of ground contact initial 20 mille-ohm MAX.after testing 40milli-ohm MAX</p>	<p>嵌合状态的连接器放置以下环境</p> <p>Apply the following environment to the mating connector in accordance</p> <p>温度 363+/-2K(90+/-2°)</p> <p>Temperature:363+/-2K(90+/-2°)</p> <p>时间:96 小时</p> <p>Duration:96 hours</p> <p>参考测试标准: EIA-364-17B;</p>
<p>1.4.15 硫化氢测试 H2S Gas</p>	<p>外观无异常,性能良好</p> <p>Appearance no abnormality adversely affecting the performance shall occur</p> <p>中心导体接触阻抗: 初期 20 mΩ, 以下, 试验后 40 mΩ以下.</p> <p>Contact resistance of inner contact initial 20 milli-ohm MAX.after testing 40milli-ohm MAX.</p> <p>外部导体接触阻抗:初期 20 mΩ以下,试验后 40 mΩ以下.</p> <p>Contact resistance of ground contact initial 20 mille-ohm MAX.after testing40milli-ohm MAX</p>	<p>嵌合状连接器放置于以下条件:</p> <p>Apply the following environment to the mating connector in accordance</p> <p>温度: 313+/-2K(40+/-2°)</p> <p>Temperature:313+/-2K(40+/-2°)</p> <p>湿度: 80+/-5%RH</p> <p>Relative Humidity: 80+/-5%RH</p> <p>气体:H2S 3+/-1ppmGas:H2S 3+/-1ppm</p> <p>时间:96 小时Duration:96 hours</p>

<p>1.4.16 盐雾腐蚀 Salt spray</p>	<p>外观无异常,性能良好 Appearance no abnormality adversely affecting the performance shall occur 中心导体接触阻抗: 初期 20 mΩ, 以下, 试验后 40 mΩ以下. Contact resistance of inner contact initial 20 milli-ohm MAX. after testing 40 milli-ohm MAX. 外部导体接触阻抗: 初期 20 mΩ 以下, 试验后 40 mΩ 以下. Contact resistance of ground contact initial 20 mille-ohm MAX. after testing 40 milli-ohm MAX</p>	<p>嵌合状连接器放置于以下条件下: Apply the following environment to the mating connector in accordance with MIL-STD-202, Method 101 Condition B 温度: 308+/-2K(35+/-2°) Temperature: 308+/-2K(35+/-2°) 盐水浓度: 5+/-1%(重量比) Salt water density by weight: 5+/-1% 时间: 48 小时 Duration: 48 hours 参考测试标准: EIA-364-26B 中方法 101, 条件 B;</p>
<p>1.4.17 可焊性 Solder ability</p>	<p>焊锡表面浸渍超过 95%. More than 95% of the dipped surface shall be wet with solder.</p>	<p>将端子沉入 245°C +/- 5°C 的焊液中 10 +/- 0.5 秒. Immerse the solder pin of the connector in the solder bath at 245°C +/- 5°C for 5 +/- 0.5 seconds</p>
<p>1.4.18 耐焊接热 Soldering Heat Resistance</p>	<p>Appearance shall not be distinct damage. More than 95% of the mountin pin surface shall be wet solder</p>	<p>(1) Reflow part : 533 ± 5K (260 ± 5 °C) Peak 503K MIN. (230°C MIN.) 40~50sec. (2) Pre-heat part: 403~473K(130~200°C) 60~120sec. *Refer to reflow temperature profile. *The number of reflow is within 2 times.</p>
	 <p>553 K (260 °C) 403~443 K (130~170°C) 60~120 sec. 10 ± 5 sec.</p>	