

	02P~10P	0.10	MAX
	11P~16P	0.12	MAX

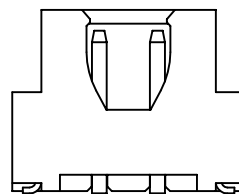

2PIN结构

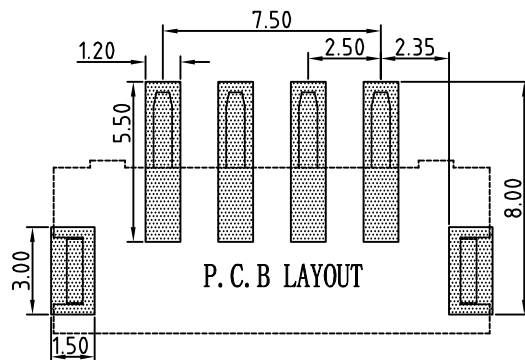
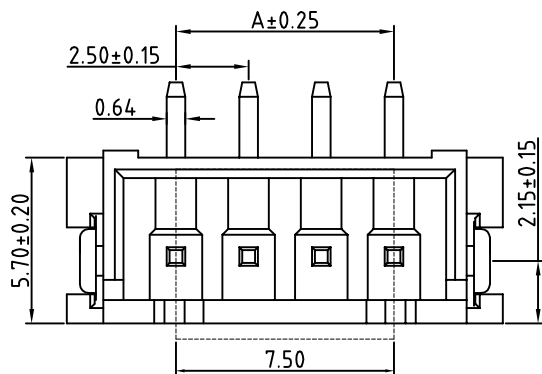
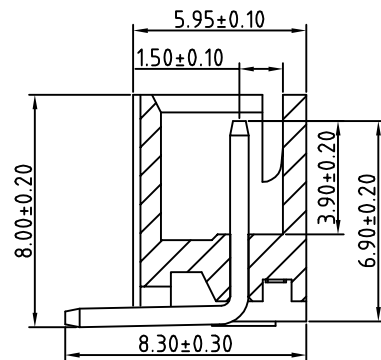
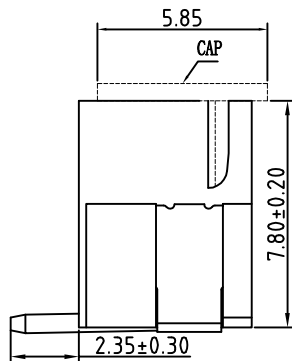
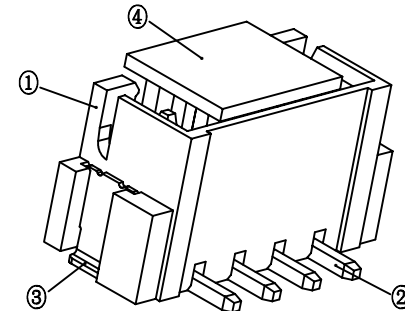

Pin	A	B	C
2	2.50	10.00	7.50
3	5.00	12.50	10.00
4	7.50	15.00	12.50
5	10.00	17.50	15.00
6	12.50	20.00	17.50
7	15.00	22.50	20.00
8	17.50	25.00	22.50
9	20.00	27.50	25.00
10	22.50	30.00	27.50
11	25.00	32.50	30.00
12	27.50	35.00	32.50
13	30.00	37.50	35.00
14	32.50	40.00	37.50
15	35.00	42.50	40.00
16	37.50	45.00	42.50

技术参数

间距: 2.5
 温度范围: -25~+85°C
 额定电压: 250V AC, DC
 额定电流: 3.0A AC, DC
 接触电阻: 20mΩ
 绝缘电阻: 800MΩ
 耐压: 1000V AC/minute

线性公差 / General Tolerance	
X	±0.2
X.X	±0.1
X.XX	±0.05
角度公差 / Angle Tolerance	
X°	±5.0°
X.X°	±3.0°
X.XX°	±1.0°

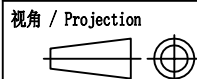

A2	提高检验效率和质量			
A1	调整平面度			
标记	变更内容	签名	年月日	
绘图				
审核				
工艺		批准		

材料 / Material

- ① 塑座: LCP 本色
- ② 接触针: 黄铜 (镀锡)
- ③ 焊片: 黄铜 (镀锡)
- ④ 吸盖: LCP 本色

单位 (Units)	版本	比例
mm	2.0	1:1
共 1 张		第 1 张



品名 / ProduceName

XH2.54 立贴 7P

型号 / Model

BX-XH2.54-7PLT