

REV.	DESCRIPTION	APPD	DATE
△/1	外壳弹片改直		
△/2	尺寸0.70改为0.55		
△/3	尺寸3.50改为2.30		
△/4	主体底部增加孔位		
△/1	增加CD PIN 高低管控		

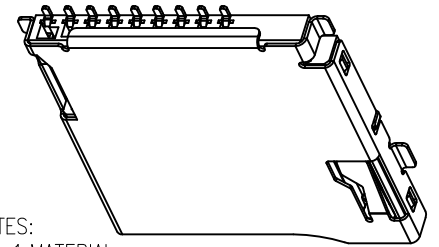

NOTES:
 1.MATERIAL:
 HOUSING: HIGH TEMPERATURE THERMOPLASTIC
 UL94V_0,COLOR:BLACK.
 CONTACT: COPPER ALLOYS.
 COVER: COPPER ALLOYS OR STEEL.
 2.PLATING:
 UNDERPLATE: NICKEL.
 CONTACT AREA: GOLD OVER NICKEL.
 SOLDER AREA: TIN OVER NICKEL.
 3.MULTIMEDIA CARD COMPATIBLE

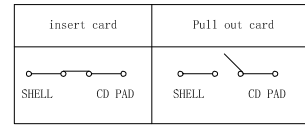

RECOMMENDED P.C.B HOLE LAYOUT
 COMPONENT SIDE VIEW(TOLERANCE: +/-0.05)

PART NO: BX-TF-1.8HJ		MATERIAL:			
LOT NO:		FINSH:			
UNIT: MM	SIZE: A4	COLOR:		TITLE: MicroSD卡(TF卡) 卡座	
TOLERANCES: X.X=±0.35 X.XX=±0.25 X.XXX=±0.15		GENERAL ANGLE: X.X=±3.0° X.XX=±2.0°		DR:	DWG NO:
		CHK:		APP:	SCALE: 1:1
					SHEET: 1 OF 3
					REV: E

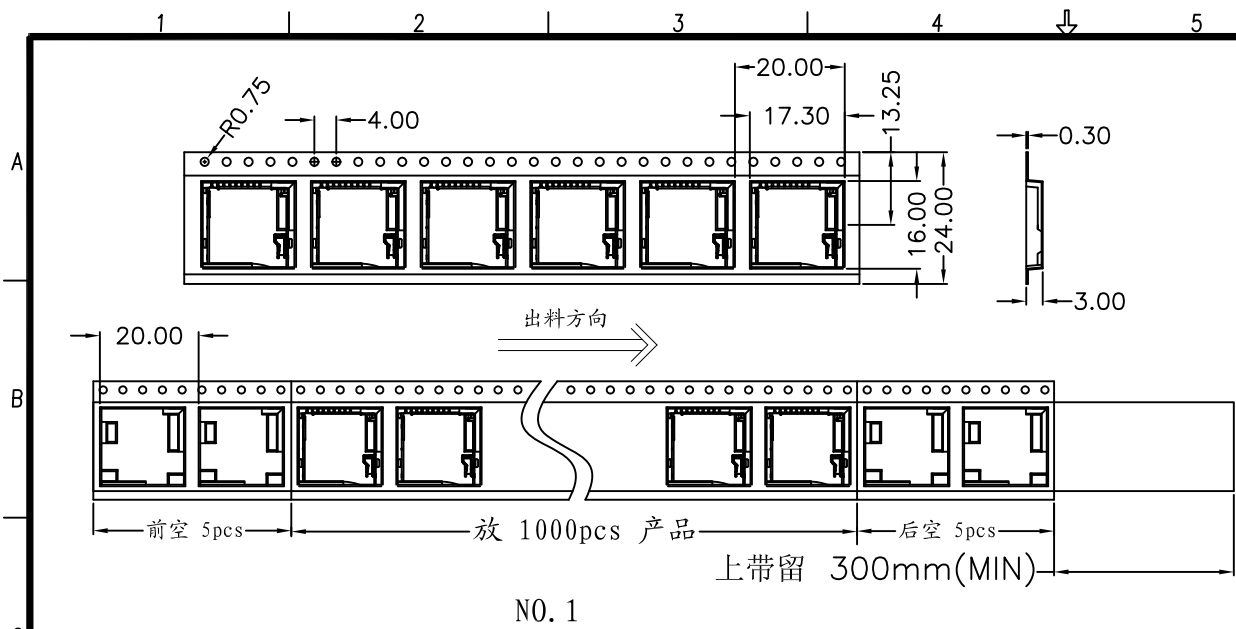

NO. 1

REV.	DESCRIPTION	APPD	DATE

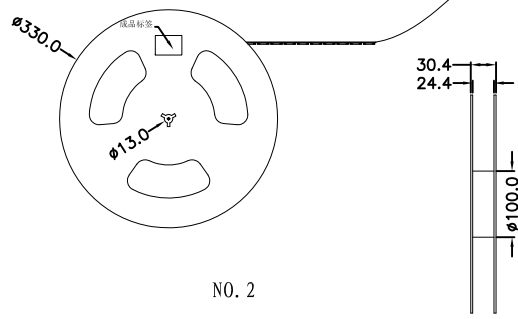

NO. 2

1. 材质要求:
- 1.1 纸箱的材质为K-K; 外形尺寸为34*34*38.5;
 - 1.2 卷盘的材质为PS, 卷盘的外形尺寸为 $\phi 330 \times 30.4$;
 - 1.3 卷带的材质为PS, 卷带的外形尺寸为20200*24.00*3.0mm;
2. 包装方式:
- 2.1 将卷带放入包装机后, 前空5PCS, 后放产品1000PCS, 再后空5PCS; 上带留300MM长度。
 - 2.2 将包装好的产品从包装机上取下并包装好, 贴上内盘标签;
 - 2.3 把累叠好的12盘叠放入纸箱中共计12Kset, 上下放纸板, 纸箱四个角塞护角纸;
 - 2.4 把包装好的成品打包封箱, 并在纸箱外贴上标签

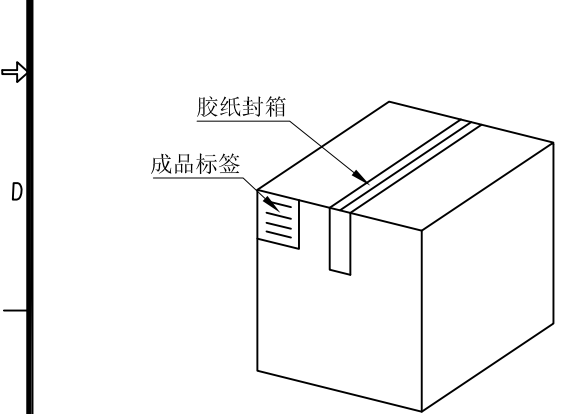

纸箱规格: 340*340*385

NO. 4

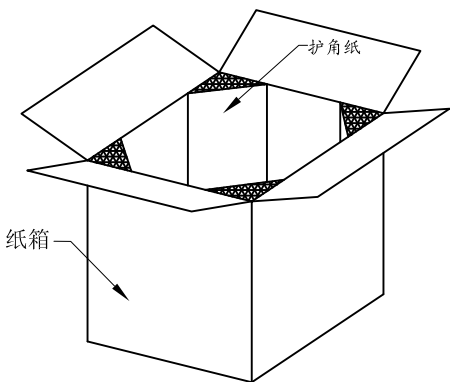
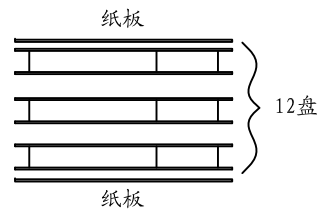

NO. 3

PART NO: BX-TF-1.8HJ		MATERIAL:			
LOT NO:		FINSH:			
UNIT: MM	SIZE: A4	COLOR:		TITLE:	
TOLERANCES: X.X=±0.35 X.XX=±0.25 X.XXX=±0.15		GENERAL ANGLE: X.X=±3.0° X.XX=±2.0°		DR:	
		CHK:		DWG NO:	
		APP:		SCALE: 1:1	
				SHEET: 3 OF 3	
				REV: B/3	

Bossie (博锡)

Mi croSD卡(TF卡) 卡座