

# 8-Port 10/100/1000T 802.3at PoE + 2-Port 10/100/1000T Desktop Switch

▶ **DT10-2G-8GP+**





**8-Port 10/100/1000T 802.3at PoE +  
2-Port 10/100/1000T Desktop Switch**



**Model: DT10-2G-8GP+**

**User's Manual**

## **FCC Warning**

This equipment has been tested and found to comply with the limits for a Class A digital device, pursuant to Part 15 of the FCC Rules. These limits are designed to provide reasonable protection against harmful interference when the equipment is operated in a commercial environment. This equipment generates, uses, and can radiate radio frequency energy and, if not installed and used in accordance with the Instruction manual, may cause harmful interference to radio communications. Operation of this equipment in a residential area is likely to cause harmful interference in which case the user will be required to correct the interference at his own expense.

## **CE Mark Warning**

This is a Class A product. In a domestic environment, this product may cause radio interference, in which case the user may be required to take adequate measures.

## **WEEE Warning**



To avoid the potential effects on the environment and human health as a result of the presence of hazardous substances in electrical and electronic equipment, end users of electrical and electronic equipment should understand the meaning of the crossed-out wheeled bin symbol. Do not dispose of WEEE as unsorted municipal waste and have to collect such WEEE separately.







# Table Of Contents

1. Introduction .....	4
1.1 Checklist.....	4
1.2 Product Description.....	4
1.3 Features .....	5
1.4 Specifications .....	6
2. Hardware Description .....	8
2.1 Front Panel .....	8
2.1.1 LED Indicators .....	10
2.2 Rear Panel .....	10
3. Hardware Installation .....	11
3.1 Desktop Installation .....	12
3.2 Rack Mounting .....	13
3.3 Wall Mounting Installation .....	14
4. Troubleshooting .....	15
Appendix A - Networking Connection.....	16
A.1 Switch's Data RJ45 Pin Assignments - 1000Mbps, 1000BASE-T.....	16
A.2 10/100Mbps, 10/100BASE-TX .....	16
Customer Support.....	18

# 1. Introduction

## 1.1 Checklist

Check the contents of your package for the following parts:

<p>DT10-2G-8GP+</p> 	<p>User's Manual x 1</p> 
<p>Power Cord x 1</p> 	<p>Rubber Feet x 4</p> 
<p>Rack-mounting Brackets x 2</p> 	<p>Screws Package x 1</p> 

## 1.2 Product Description

To fulfill the demand of sufficient PoE power for network applications with Gigabit speed transmission, DT10-2G-8GP+, 8-Port 10/100/1000T 802.3at PoE + 2-Port 10/100/1000T Desktop Switch, features up to 32 watts of power output for each port and a total PoE budget of 120 watts for eight 10/100/1000Mbps TP ports, and two 10/100/1000Mbps uplink ports. The eight 802.3at PoE+ ports provide PoE power injector function which can drive up to 8 IEEE 802.3at compliant powered devices. The DT10-2G-8GP+ also provides a simple, cost-effective, and non-blocking wire-speed performance with 9-inch metal housing suitable for desktop deployment for SOHO and department network applications.

All RJ45 copper interfaces support 10/100/1000Mbps auto-negotiation for optimal speed detection through RJ45 Category 5, 5e or 6 cables. It also supports standard auto-MDI/MDI-X that can detect the type of connection to any Ethernet device without requiring special straight-through or crossover cables.

---

## 1.3 Features

### ➤ Physical Port

- 10-port 10/100/1000BASE-T Gigabit Ethernet RJ45 copper
- 8-port IEEE 802.3at/af PoE Injector (Port-1 to Port-8)

### ➤ Power over Ethernet

- Complies with IEEE 802.3af/at Power over Ethernet end-span PSE
- Up to 8 ports of IEEE 802.3af/802.3at devices powered
- Supports PoE Power up to 32 watts for each PoE port
- Each port supports 54V DC power to PoE powered device
- 120-watt PoE budget
- Auto detects powered device (PD)
- Supports PD alive function
- Circuit protection prevents power interference between ports
- Remote power feeding up to 100m in standard mode with 250m in extended mode

### ➤ Switching

- Hardware-based 10/100/1000Mbps auto-negotiation and auto MDI/MDI-X
- Flow control for full duplex operation and back pressure for half duplex operation
- Integrates address look-up engine, supporting 2K absolute MAC addresses
- 9K jumbo frame supports all speeds (10/100/1000Mbps)
- Hardware DIP switch for **Standard**, **VLAN** and **Extend** mode selection; the Extend mode features 30-watt PoE transmit distance of 250m at speed of 10Mbps and VLAN isolation (Only for Port-1 to Port-8)
- Solid DIP switch to isolate ports to prevent broadcast storm and defend DHCP spoofin

### ➤ Hardware

- 9-inch desktop size, 1U height, rack mountable
- LED indicators for system power, per port PoE ready and PoE activity, speed, Link/Act
- 1 silent fan to provide stable and efficient power performance
- Supports Energy-Efficient Ethernet (EEE) function (IEEE 802.3az)

## 1.4 Specifications

Model	DT10-2G-8GP+
Hardware Specifications	
Copper Port	10 10/100/1000BASE-T MDI/MDIX Ports (RJ45)
PoE Injector Port	8-port with 802.3at/af PoE injector function with Port-1 to Port-8 (RJ45)
Switch Architecture	Store-and-Forward
Switch Fabric	20Gbps/non-blocking
Switch Throughput@64 bytes	13.4Mpps@64 bytes
MAC Address Table	2K entries, automatic source address learning and aging
Maximum Frame Size	9K bytes
Flow Control	IEEE 802.3x pause frame for full-duplex Back pressure for half-duplex
LED	<p><b>System:</b></p> <ul style="list-style-type: none"> <li>■ Power (Green)</li> </ul> <p><b>10/100/1000BASE-T RJ45 interfaces:</b></p> <ul style="list-style-type: none"> <li>■ 1000Mbps LNK/ACT (Green)</li> </ul> <p><b>PoE interfaces:</b></p> <ul style="list-style-type: none"> <li>■ PoE-in-Use (Orange)</li> </ul>
DIP Switch	<p>Selectable operation mode</p> <ul style="list-style-type: none"> <li>■ Standard</li> <li>■ VLAN</li> <li>■ Extend</li> </ul>
Dimensions (W x D x H)	220 x 150 x 43 mm (1U height)
Enclosure	Metal
Weight	1205 g
Power Requirements	AC 100~240V, 50/60Hz, 2.5A max.
Power Consumption/Dissipation	Max. 120 watts/409.4 BTU
Thermal Fan	1

Power over Ethernet	
PoE Standard	IEEE 802.3af Power over Ethernet/PSE IEEE 802.3at Power over Ethernet Plus/PSE
PoE Power Supply Type	End-span
PoE Power Output	Per port 54V DC, 600mA. max. 32 watts
Power Pin Assignment	1/2(+), 3/6(-)
PoE Power Budget	120 watts
Max. Number of Class 2 PDs	8
Max. Number of Class 3 PDs	8
Max. Number of Class 4 PDs	4
Standards Conformance	
Regulatory Compliance	FCC Part 15 Class A, CE
Standards Compliance	IEEE 802.3 10BASE-T IEEE 802.3u 100BASE-TX IEEE 802.3ab Gigabit 1000BASE-T IEEE 802.3x Flow control and back pressure IEEE 802.3af Power over Ethernet IEEE 802.3at Power over Ethernet Plus IEEE 802.3az Energy Efficient Ethernet (EEE)
Environment	
Operating	Temperature: 0 ~ 50 degrees C Relative Humidity: 5 ~ 95% (non-condensing)
Storage	Temperature: -10 ~ 70 degrees C Relative Humidity: 5 ~ 95% (non-condensing)



## 2. Hardware Description

The switch provides three different running speeds – 10Mbps, 100Mbps and 1000Mbps, and automatically distinguishes the speed of the incoming connection. For easier management and control of the DT10-2G-8GP+, familiarize yourself with its display indicators and ports. Front panel illustrations in this chapter display the unit LED indicators. Before connecting any network device to the DT10-2G-8GP+, please read this chapter carefully.

### 2.1 Front Panel

The Front Panel of the DT10-2G-8GP+ PoE+ Ethernet Switch consists of 10 Auto-Sensing 10/100/1000Mbps Ethernet RJ45 Ports. The LED Indicators are also located on the front panel.

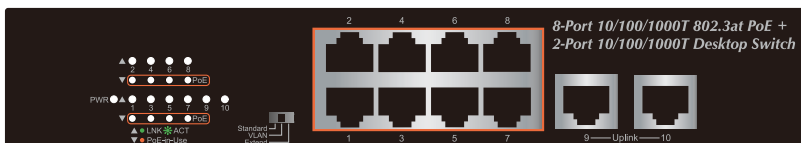

DT10-2G-8GP+ Switch Front Panel



#### Note

Model number may or may not be permanently screen printed on front of unit.

The front panel provides one DIP switch for **Standard**, **VLAN** and **Extend** mode selections. The detailed descriptions are shown in the following table.

DIP Switch Mode	Function
<p>Standard VLAN Extend</p>	<p>Standard mode makes the DT10-2G-8GP+ operate as a general switch and all PoE ports operate at 10/100/1000Mbps auto-negotiation.</p>
<p>Standard VLAN Extend</p>	<p>VLAN mode makes the DT10-2G-8GP+ operate as a <b>VLAN isolation</b> switch where</p> <ol style="list-style-type: none"> <li>1. Port 1 to port 8 will isolate respectively</li> <li>2. Port 1 to port 8 will only communicate with port 9 and port 10 (uplink ports).</li> </ol>



Extend mode makes the DT10-2G-8GP+ operate as a VLAN isolation switch where

1. Port 1 to port 8 will isolate respectively.
2. Port 1 to port 8 will only communicate with port 9 and port 10 (uplink ports).
3. 30-watt PoE transmit distance of 250m at speed of 10Mbps.

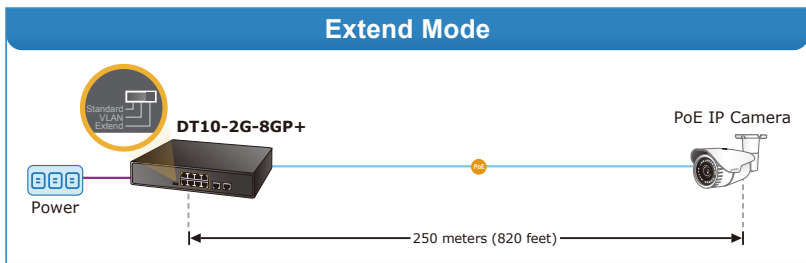
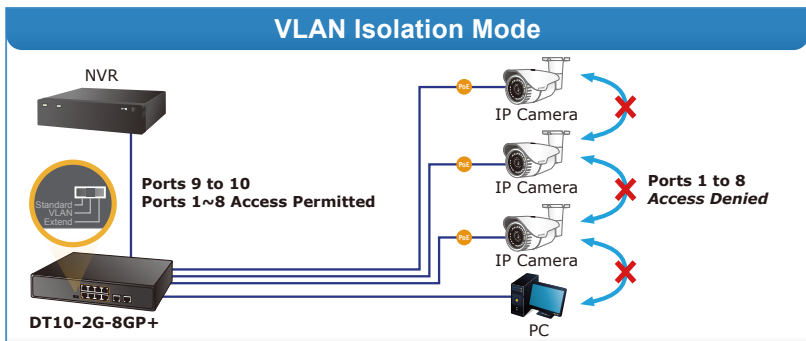
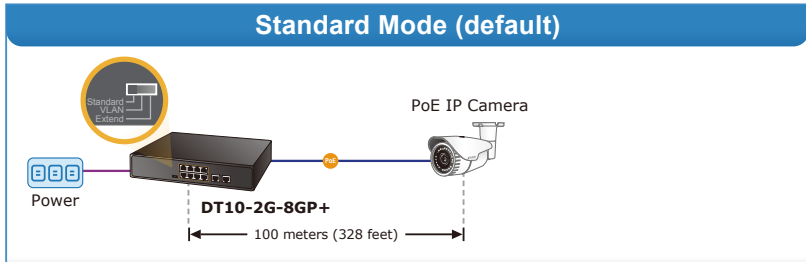

## 2.1.1 LED Indicators

### ■ System

LED	Color	Function
PWR	Green	Lights to indicate that the Switch has power.

### ■ Per 10/100/1000Mbps Port

LED	Color	Function
PoE-in-use	Orange	Lights to indicate the port is providing 54V DC in-line power. (1-8 ports)
Speed/ LNK/ACT	Green	Lights to indicate the Switch is successfully connecting to the network at 10/100/1000Mbps. Blinks to indicate that the Switch is actively sending or receiving data over that port.

## 2.2 Rear Panel

The rear panel of the DT10-2G-8GP+ has an AC inlet power socket, which accepts input power of 100 to 240V AC, 50-60Hz.



DT10-2G-8GP+ Switch Rear Panel



### Power Note

1. The device is a power-required device which means it will not work till it is powered. If your networks require constant power without interruption, consider using UPS (Unin-terrupted Power Supply) for your device. It will prevent network data loss and network downtime in the event of interrupted power.
2. In some areas, installing a surge suppression device may also help to protect your DT10-2G-8GP+ from being damaged by unregulated surge or current.

### 3. Hardware Installation

#### Start up

Please refer to the following for your cabling:

##### ■ 10/100/1000BASE-T

All 10/100/1000BASE-T ports come with Auto-Negotiation capability. They automatically support 1000BASE-T, 100BASE-TX and 10BASE-T networks. Users only need to plug a working network device into one of the 10/100/1000BASE-T ports, and then turn on DT10-2G-8GP+. The port will automatically run in 10Mbps, 20Mbps, 100Mbps, 200Mbps, 1000Mbps or 2000Mbps after the negotiation with the connected device.

##### ■ Cabling

Each of the 10/100/1000BASE-T ports uses RJ45 sockets for connection of twisted-pair cable. The IEEE 802.3/802.3u/802.3ab Fast/Gigabit Ethernet standard requires Category 5 for 100Mbps 100BASE-TX. 10BASE-T networks can use Cat.3, 4, 5 or 1000BASE-T uses 5/5e/6 (see table below). Maximum distance is 100 meters (328 feet).

Port Type	Cable Type	Connector
10BASE-T	Cat.3, 4, 5, 2-pair	RJ45
100BASE-TX	Cat.5, 5e UTP, 4-pair	RJ45
1000BASE-T	Cat.5/5e/6 UTP, 4-pair	RJ45

Any Ethernet devices such as hubs/PCs can be connected to the DT10-2G-8GP+ by using straight-through wires. The whole 10/100/1000Mbps ports are auto-MDI/MDI-X that can be used with either straight-through or crossover cable.

## 3.1 Desktop Installation

To install the DT10-2G-8GP+ on a desktop, simply follow the following steps:

**Step 1:** Attach the rubber feet to the recessed areas on the bottom of the DT10-2G-8GP+, as shown below.

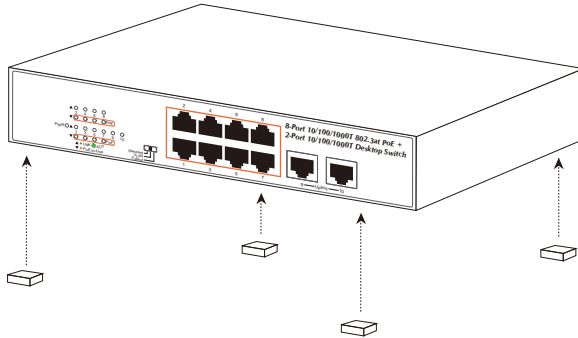

Attaching the Rubber Feet to the DT10-2G-8GP+

**Step 2:** Place the DT10-2G-8GP+ on a desktop near an AC power source.

**Step 3:** Keep enough ventilation space between the DT10-2G-8GP+ and the surrounding objects to allow for air flow.



### Note

When choosing a location, please keep in mind the environmental restrictions discussed in Chapter 1, Section 4, under Specifications.

**Step 4:** Connect your DT10-2G-8GP+ to 802.3af/802.3at complied power devices (PD) and other network devices. Connect one end of a standard Ethernet network cable to the 10/100/1000BASE-T RJ45 ports on the front panel of the DT10-2G-8GP+. Connect the other end of the cable to the network devices such as printer servers, workstations, routers, cameras, IP phones, etc.

**Step 5:** Supply power to the DT10-2G-8GP+. Connect one end of the power cable to the Switch and connect the power plug of the power cable to a standard wall outlet.

When the DT10-2G-8GP+ receives power, the Power LED should remain solid Green.

## 3.2 Rack Mounting

To install the DT10-2G-8GP+ in a 19-inch standard rack, follow the instructions described below.

**Step 1:** Place your DT10-2G-8GP+ on a hard, flat surface, with the front panel positioned towards your front side.

**Step 2:** Attach a rack-mount bracket to each side of the DT10-2G-8GP+ with the supplied screws as shown below.

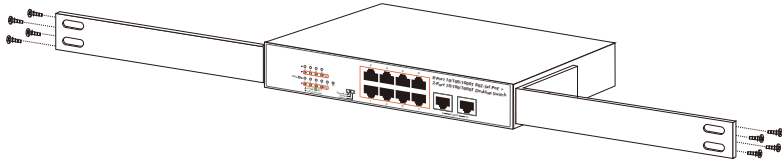

Attaching the Brackets to the DT10-2G-8GP+



You must use the screws supplied with the mounting brackets. Damage caused to the parts by using incorrect screws will invalidate the warranty.

**Step 3:** Secure the brackets tightly.

**Step 4:** Follow the same steps to attach the second bracket to the opposite side.

**Step 5:** After the brackets are attached, use suitable screws to securely attach the brackets to the rack, as shown below.

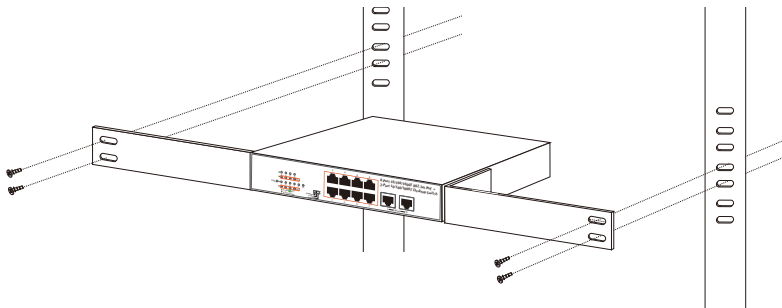

Mounting the DT10-2G-8GP+ in a Rack

**Step 6:** Proceed with Steps 4 and 5 of session 3.1 Desktop Installation to connect the network cabling and supply power to your Switch.

### 3.3 Wall Mounting Installation

**Step 1:** Install two screws on the wall 150mm apart as shown below.

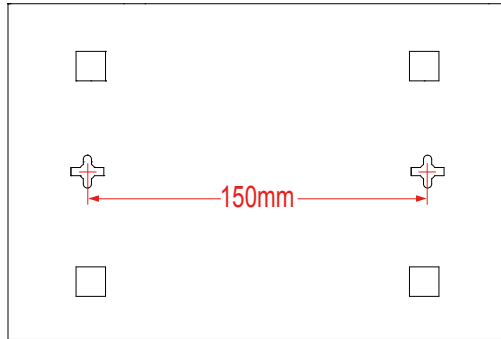

**Step 2:** Hang the DT10-2G-8GP+ on the screws from the wall.

**Step 3:** Repeat step 5 of Desktop Installation for power supply to the Switch.



Note

Before mounting the device to the wall, please check the location of the electrical outlet and the length of the Ethernet cable

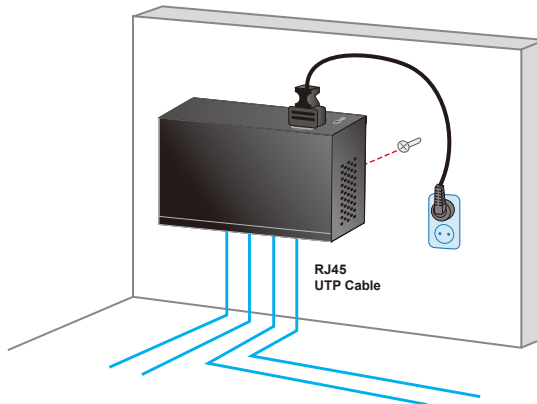

---

## 4. Troubleshooting

This chapter contains information to help you solve issues. If the DT10-2G-8GP+ is not functioning properly, make sure the DT10-2G-8GP+ was set up according to instructions in this manual

### **The Link LED is not lit.**

#### **Solution:**

Check the cable connection or swap to a different cable.

### **1000BASE-T port link LED is lit, but the traffic is irregular.**

#### **Solution:**

Make sure the attached device is not set to full duplex. Some devices use a physical or software switch to change duplex modes. Auto-negotiation may not recognize this type of full-duplex setting.

### **Why the Switch is not connected to the network.**

#### **Solution:**

Check the LNK/ACT LED on the DT10-2G-8GP+. Try another port on the DT10-2G-8GP+. Make sure the cable is installed properly. Make sure the cable is the right type. Turn off the power. After a while, turn on the power again.

### **Why the DT10-2G-8GP+, connected to PoE device, cannot be powered on.**

#### **Solution:**

Please check the cable type of the connection from the DT10-2G-8GP+ to the other end. The cable should be an 8-wire, Category 5 or above Ethernet cable using EIA568 standards within 100 meters. A cable with only 4-wires, a short loop or over 100 meters will affect the power supply.

Please make sure the device is fully compliant with IEEE 802.3af/IEEE 802.3at standard.

### **What is the power output of each PoE port?**

#### **Solution:**

1. Each PoE port supports 53V-54 DC, 600mA and a maximum of 30 watts of power output. Detected and injected by the standard of IEEE 802.3at.
2. Each PoE port supports 53V-54 DC, 300mA and a maximum of 15.4 watts of power output. Detected and injected by the standard of IEEE 802.3af



## Appendix A - Networking Connection

### A.1 Switch's Data RJ45 Pin Assignments - 1000Mbps, 1000BASE-T

PIN NO	MDI	MDI-X
1	BI_DA+	BI_DB+
2	BI_DA-	BI_DB-
3	BI_DB+	BI_DA+
4	BI_DC+	BI_DD+
5	BI_DC-	BI_DD-
6	BI_DB-	BI_DA-
7	BI_DD+	BI_DC+
8	BI_DD-	BI_DC-

Implicit implementation of the crossover function within a twisted-pair cable, or at a wiring panel, while not expressly forbidden, is beyond the scope of this standard.

### A.2 10/100Mbps, 10/100BASE-TX

When connecting Switch to another Fast Ethernet switch, a straight-through or crossover cable might be necessary. Each port of the Switch supports auto-MDI/MDI-X detection, meaning you can directly connect the Switch to any Ethernet devices without making a crossover cable. The following table and diagram show the standard RJ45 receptacle/connector and their pin assignments:

RJ45 Connector Pin Assignment		
Contact	MDI Media Dependent Interface	MDI-X Media Dependent Interface-Cross
1	Tx + (transmit)	Rx + (receive)
2	Tx - (transmit)	Rx - (receive)
3	Rx + (receive)	Tx + (transmit)
4, 5	Not used	
6	Rx - (receive)	Tx - (transmit)
7, 8	Not used	

The standard cable, RJ45 pin assignment

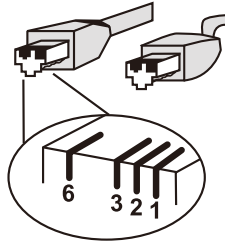

The standard RJ45 receptacle/connector

There are 8 wires on a standard UTP/STP cable and each wire is color-coded. The following shows the pin allocation and color of straight-through cable and crossover cable connection:

<b><u>Straight Cable</u></b>		<b><u>SIDE 1</u></b>	<b><u>SIDE 2</u></b>
1	2	3	4
5	6	7	8
1	2	3	4
5	6	7	8
		<b><u>SIDE 1</u></b>	<b><u>SIDE 2</u></b>
		1 = White/Orange	1 = White/Orange
		2 = Orange	2 = Orange
		3 = White/Green	3 = White/Green
		4 = Blue	4 = Blue
		5 = White/Blue	5 = White/Blue
		6 = Green	6 = Green
		7 = White/Brown	7 = White/Brown
		8 = Brown	8 = Brown
<b><u>Cross Over Cable</u></b>		<b><u>SIDE 1</u></b>	<b><u>SIDE 2</u></b>
1	2	3	4
5	6	7	8
1	2	3	4
5	6	7	8
		<b><u>SIDE 1</u></b>	<b><u>SIDE 2</u></b>
		1 = White/Orange	1 = White/Green
		2 = Orange	2 = Green
		3 = White/Green	3 = White/Orange
		4 = Blue	4 = Blue
		5 = White/Blue	5 = White/Blue
		6 = Green	6 = Orange
		7 = White/Brown	7 = White/Brown
		8 = Brown	8 = Brown

**Figure A-1:** Straight-through and Crossover Cable

Please make sure your connected cables are with the same pin assignment and color as the above description before deploying the cables into your network.

---

## ***Customer Support***

Thank you for purchasing L-com products. You can browse our online resources and User's Manuals on [www.L-com.com](http://www.L-com.com). If you require sales or support information, please contact the L-com support team using the information found below.



L-com  
50 High Street  
West Mill, 3rd Floor, Suite 30  
North Andover, MA 01845 USA  
Toll Free: (800)-341-5266  
International: (978)-68-6936  
Sales and Support: [Sales@L-com.com](mailto:Sales@L-com.com)

2351-AK3270-A30

**Warning:**

This device is compliant with Class A of CISPR 32.  
In a residential environment this device may cause radio interference.



**Energy Saving Note of the Device**

This power required device does not support Standby mode operation. For energy savings, please remove the power cable to disconnect the device from the power circuit. Without removing the power cable, the device will still consume power from the power source. In view of Saving the Energy and reducing the unnecessary power consumption, it is strongly suggested to remove the power cable from the device if this device is not intended to be active.