

Silicon N-Channel Power MOSFE

Description

The MD3N150 uses advanced technology and design to provide excellent $R_{DS(ON)}$. It can be used in a wide variety of applications.

General Features

- ① $V_{DS}=1500V, R_{ds(on)}<9m\Omega @V_{GS}=10V, I_D=3A (T_{yp}:5.2m\Omega)$
- ② Low ON Resistance
- ③ Low Reverse transfer capacitances
- ④ 100% Single Pulse avalanche energy Test

Application

- ① Power Switching application
- ② Adapter and charger

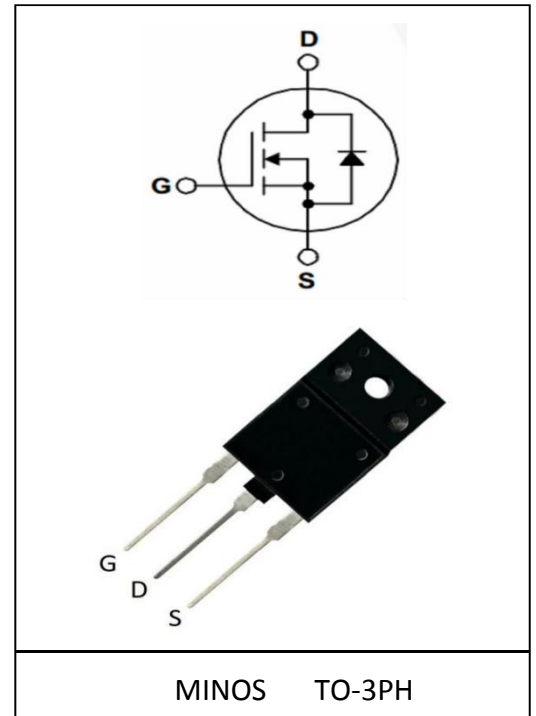

Package Marking And Ordering Information:

Ordering Codes	Package	Product Code	Packing
MD3N150	TO-3PH	MD3N150	Tube

Electrical Characteristics @ $T_a=25^\circ C$ (unless otherwise specified)

Absolute Maximum Ratings:

Symbol	Parameter	Value	Unit
V_{DSS}	Drain-to-Source Breakdown Voltage	1500	V
I_D	Drain Current (continuous) at $T_c=25^\circ C$	3	A
I_{DM}	Drain Current (Pulsed)	12	A
V_{GS}	Gate to Source Voltage	± 30	V
P_{tot}	Total Dissipation at $T_c=25^\circ C$	250	W
T_j	Max. Operating Junction Temperature	175	$^\circ C$
Eas	Single Pulse Avalanche Energy	125	mJ



迈诺斯科技

MD3N150

Electrical Parameters:

Symbol	Parameter	Test Conditions	Min	Typ	Max	Unit
V _{DS}	Drain-source Voltage	V _{GS} =0V, I _D =250μA	1500			V
R _{Ds(on)}	Static Drain-to-Source on-Resistance	V _{GS} =10V, I _D =1.5A		5.2	9.0	Ω
V _{GS(th)}	Gated Threshold Voltage	V _{DS} =V _{GS} , I _D =250μA	3.0	4.1	5.0	V
I _{DSS}	Drain to Source leakage Current	V _{DS} =1500V, V _{GS} =0V			1	μA
I _{GSS(F)}	Gated to Source Foward Leakage	V _{GS} =+30V			100	nA
I _{GSS(R)}	Gated to Source Reverse Leakage	V _{GS} =-30V			-100	nA
C _{iss}	Input Capacitance	V _{GS} =0V, V _{DS} =25V, f=1.0MHZ		1938		pF
C _{oss}	Output Capacitance			5104		pF
C _{rss}	Reverse Transfer Capacitance			2.4		pF

Switching Characteristics

Symbol	Parameter	Test Conditions	Min	Typ	Max	Unit
t _{d(on)}	Turn-on Delay Time	V _{DD} =750V, I _D =3A, R _G =10Ω		33.8		nS
t _r	Turn-on Rise Time			16.7		nS
t _{d(off)}	Turn-off Delay Time			56		nS
t _f	Turn-off Fall Time			27.6		nS
Q _g	Total Gate Charge	V _{DS} =750V		9.3		nC
Q _{gs}	Gate-Source Charge	I _D =3A		174.9		nC
Q _{gd}	Gate-Drain Charge	V _{GS} =10V		5.3		nC

Source-Drain Diode Characteristics

Symbol	Parameter	Test Conditions	Min	Typ	Max	Unit
I _{SD}	S-D Current(Body Diode)				3	A
I _{SDM}	Pulsed S-D Current(Body Diode)				12	A
V _{SD}	Diode Forward Voltage	V _{GS} =0V, I _{DS} =3.0A			1.5	V
t _{rr}	Reverse Recovery Time	T _J =25°C, I _F =3.0A di/dt=100A/us		302.3		nS
Q _{rr}	Reverse Recovery Charge				9.9	

*Pulse Test: Pulse Width ≤ 300μs, Duty Cycle < 2%

Symbol	Parameter	Typ	Units
R _{θJC}	Junction-to-Case	1.7	°C/W

Typical Performance Characteristics

Fig.1 Safty peration area

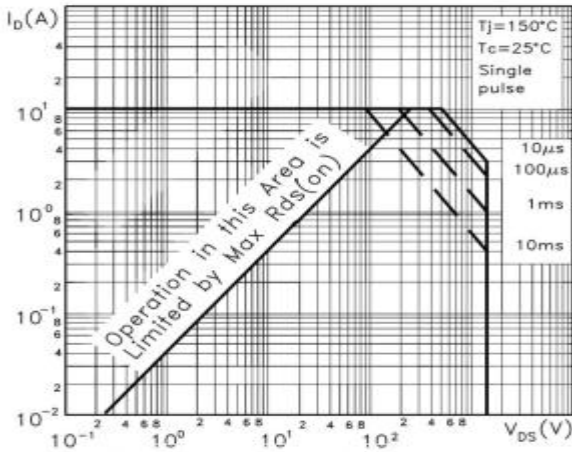

Fig.2 Thermal impedance

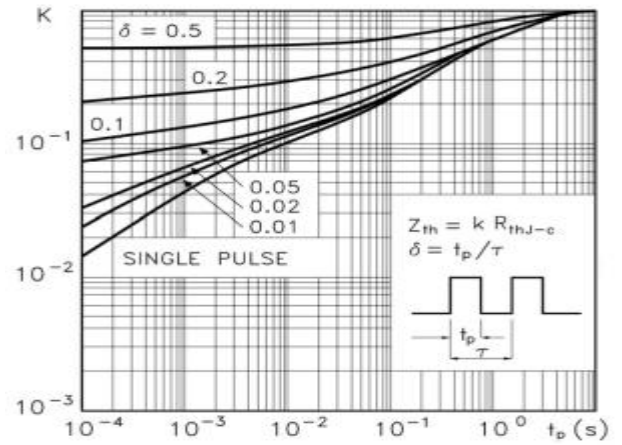

Fig.3 Output characteristics

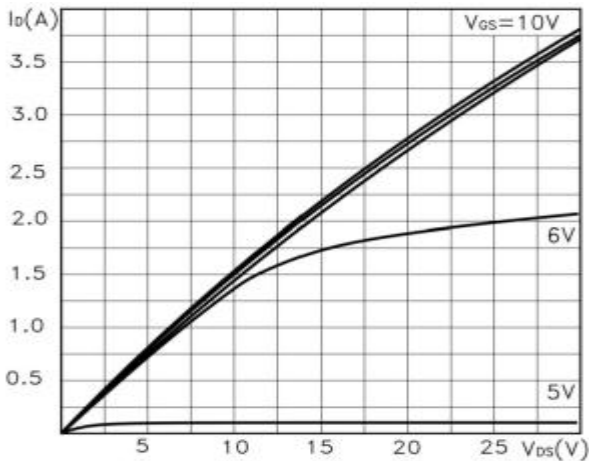

Fig.4 Transfer characteristics

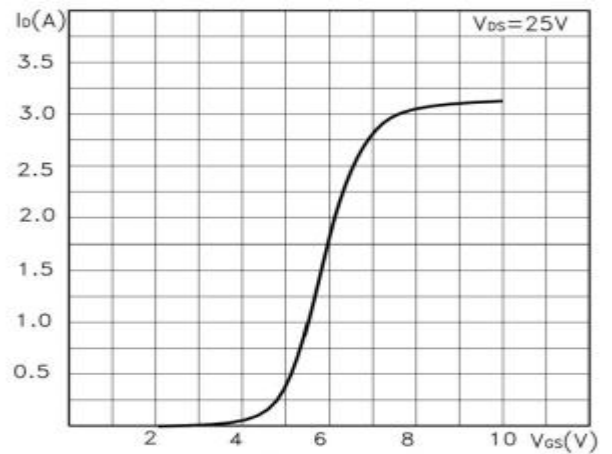

Fig.5 Normalized BVDSS vs.temperature

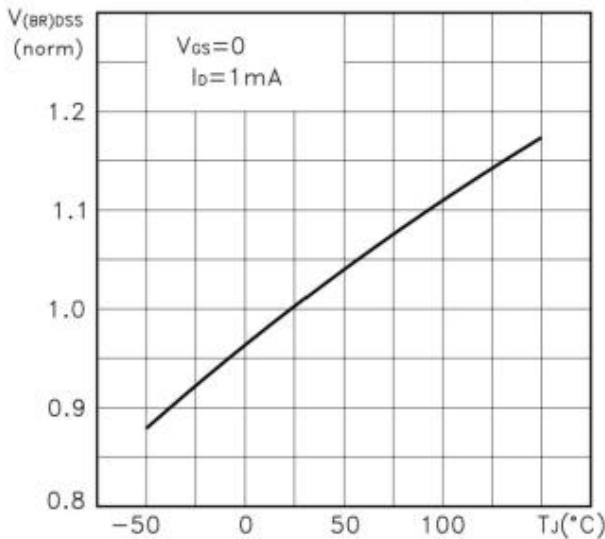

Fig.6 Static drain-source on resistance

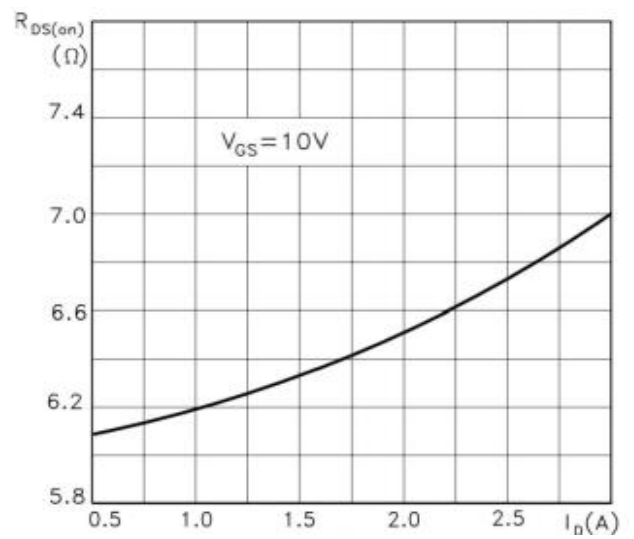

Fig.7 Gate charge vs.gate-source voltage

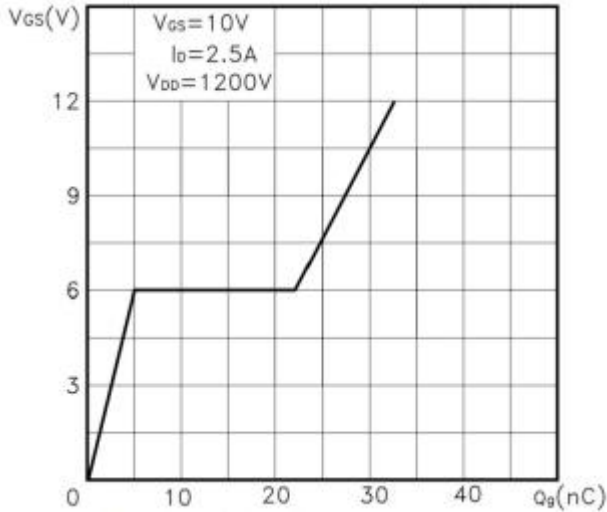

Fig.8 Capacitance variations

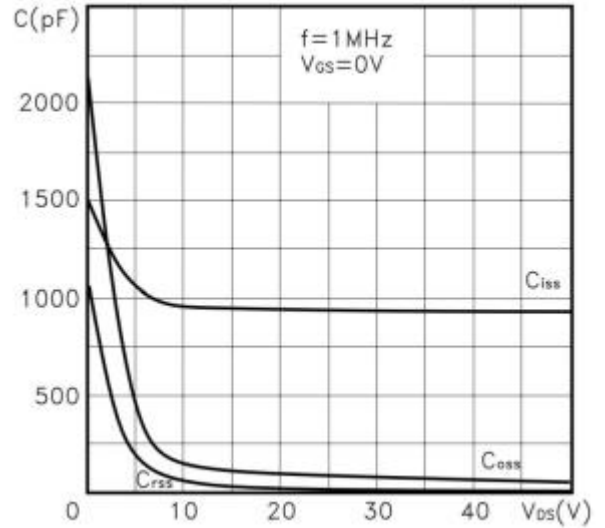

Fig.9 Normalized gate threshold voltage vs.temperature

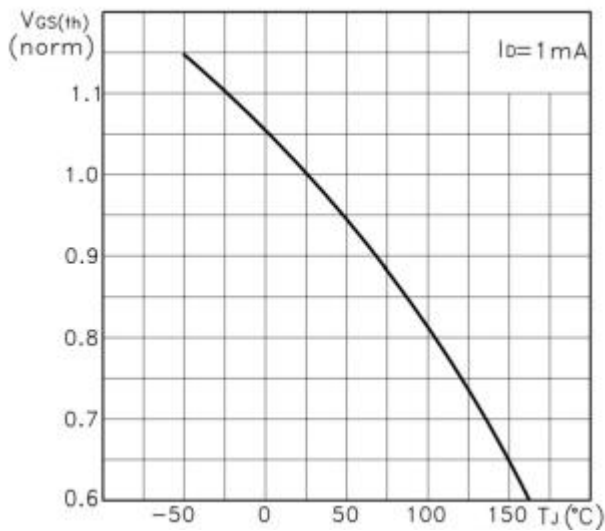

Fig.10 Capacitance variations

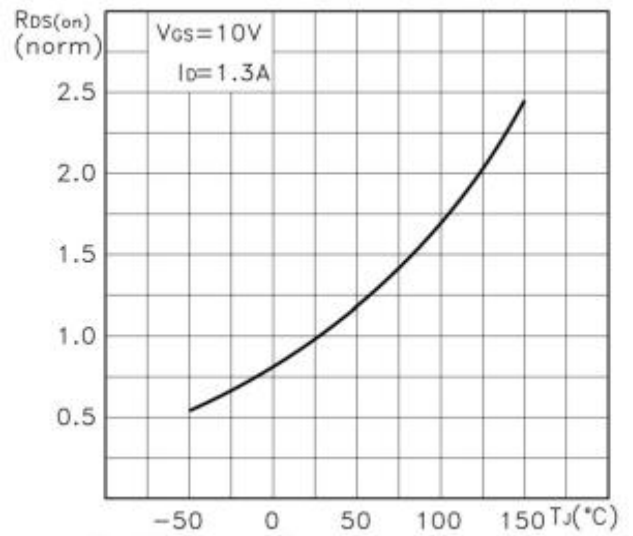

Fig.11 Normalized gate threshold voltage vs.temperature

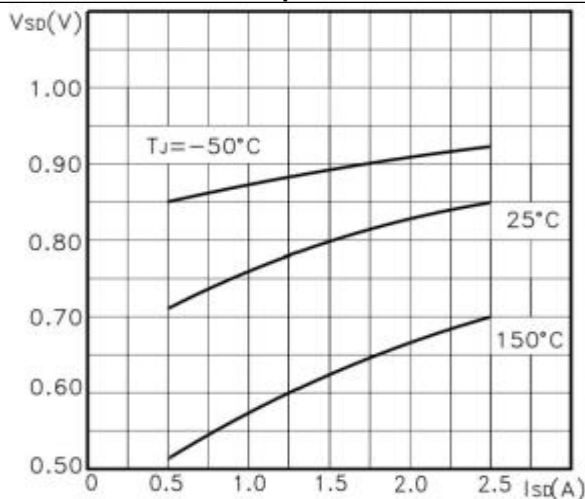
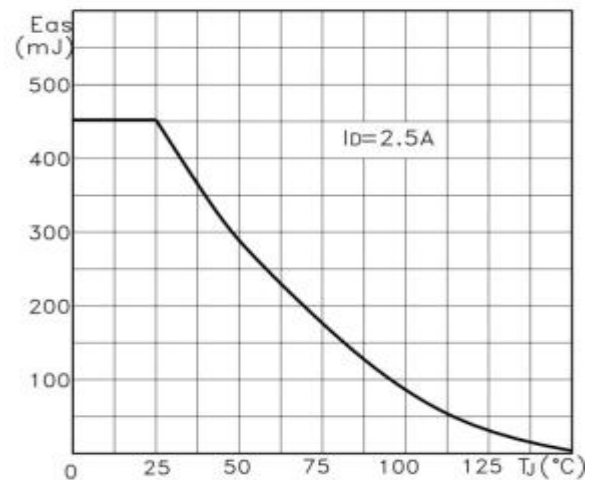
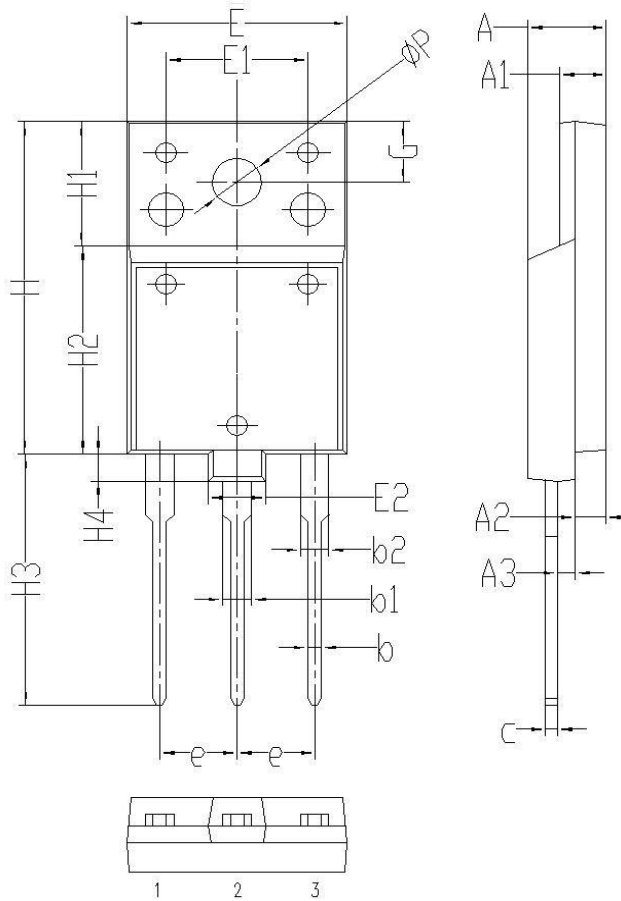

Fig.12 Normalized on resistance vs.temperature



Package Description

TO-3PH PACKAGE



Symbol	单位 mm		
	Min	Nom	Max
A	5.35	5.55	5.75
A1	2.80	3.00	3.20
A2	1.90	2.10	2.30
A3	1.10	1.30	1.50
b	0.65	0.75	0.85
b1	1.80	2.00	2.20
b2	1.80	2.00	2.20
c	0.70	0.90	1.10
e	5.25	5.45	5.65
E	15.3	15.5	15.7
E1	9.80	10.0	10.2
E2	3.80	4.00	4.20
H	24.3	24.5	24.7
H1	9.00	9.20	9.40
H2	15.1	15.3	15.5
H3	18.5	19.0	19.5
H4	1.80	2.00	2.20
H5	4.80	5.00	5.20
G	4.3	4.5	4.7
ΦP	3.40	3.60	3.80



NOTE:

1. Exceeding the maximum ratings of the device in performance may cause damage to the device, even the permanent failure, which may affect the dependability of the machine. Please do not exceed the absolute maximum ratings of the device when circuit designing.
2. When installing the heat sink, please pay attention to the torsional moment and the smoothness of the heat sink.
3. MOSFETs is the device which is sensitive to the static electricity, it is necessary to protect the device from being damaged by the static electricity when using it.
4. Shenzhen Minos reserves the right to make changes in this specification sheet and is subject to change without prior notice.

CONTACT:

深圳市迈诺斯科技有限公司（总部）

地址：深圳市福田区华富街道田面社区深南中路4026号田面城市大厦22B-22C

邮编：518025

电话：0755-83273777