



Features

- Low on-resistance
- N-Channel MOSFET
- Low input capacitance
- Fast switching speed
- ESD Protection

Shipping Quantity

- 3000pcs / Tape & Reel

Typical Applications

- DC-DC converters
- Power management functions
- Battery operated systems and solid-state relays
- Drivers: Relays, Solenoids, Lamps, Hammers, Displays, Memories, Transistors, etc.

Mechanical Data

- Case: SOT-323
- Molding Compound, UL Flammability Classification Rating 94V-0
- Terminals: Matte Tin Plated Leads, Solderable Per MIL-STD-202, Method 208

Circuit Diagram

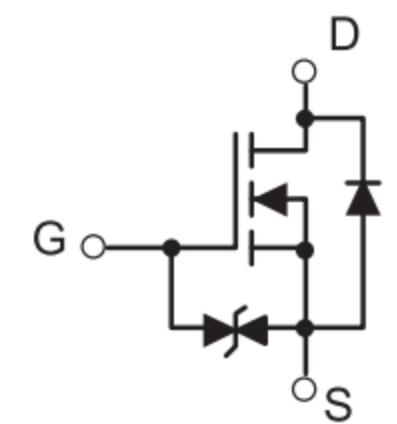
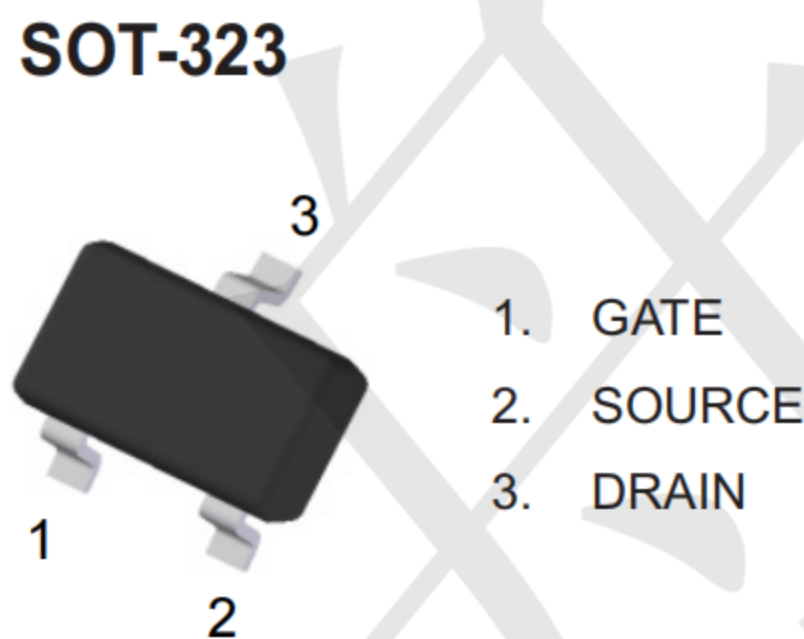

N-MOS

Marking:SS

Absolute Maximum Ratings (Tamb=25°C unless otherwise specified)

Parameter	Symbol	Value	Units
Drain-Source Voltage	V_{DSS}	50	V
Gate -Source Voltage	V_{GSS}	±20	V
Continuous Drain Current ($T_A = 25^\circ C$) *1	I_D	360	mA
Pulsed Drain Current ($t_p = 10\mu s, T_A = 25^\circ C$)	I_{DM}	1500	mA
Single Pulse Avalanche Energy *2	E_{AS}	0.2	mJ
Power Dissipation	SOT-323 P_D	0.26	W



Thermal Characteristics

Parameter	Symbol	Limits	Unit
Thermal Resistance Junction to Ambient Air	$R_{\theta JA}$	480	°C/W
Thermal Resistance Junction to Lead	$R_{\theta JL}$	288	
Thermal Resistance Junction to Case	$R_{\theta JC}$	242	
Operating Junction Temperature Range	T_J	-55 to +150	°C
Storage Temperature Range	T_{STG}	-55 to +150	°C

Electrical Characteristics (TA=25°C unless otherwise specified)

Symbol	Parameter	Test conditions	MIN	TYP	MAX	UNIT
OFF Characteristics						
V_{DSS}	Drain-Source Breakdown Voltage	$V_{GS} = 0V, I_D = 250\mu A$	50	-	-	V
I_{DSS}	Drain to Source Leakage Current	$V_{DS} = 50V, V_{GS} = 0V$	-	-	1	μA
I_{GSS}	Gate-body Leakage	$V_{GS} = \pm 20V, V_{DS} = 0V$	-	-	± 10	μA
ON Characteristics						
$R_{DS(ON)}$	Drain-Source On-resistance *1	$V_{GS} = 10V, I_D = 0.5A$	-	1.5	2.0	Ω
		$V_{GS} = 4.5V, I_D = 0.2A$	-	1.7	2.5	
		$V_{GS} = 2.5V, I_D = 0.1A$	-	2.0	4.5	
$V_{GS(TH)}$	Gate Threshold Voltage	$V_{DS} = V_{GS}, I_D = 250\mu A$	0.8	1	1.5	V
R_G	Gate Resistance	$V_{GS} = 0V, f = 1MHz$	-	48	-	Ω
Dynamic Characteristics						
C_{ISS}	Input Capacitance	$V_{GS} = 0V$	-	32	-	pF
C_{OSS}	Output Capacitance	$V_{DS} = 25V$	-	6	-	
C_{RSS}	Reverse Transfer Capacitance	$f = 1.0MHz$	-	3	-	
Switching Characteristics						
$t_{d(on)}$	Turn-on Delay Time *3	$V_{DD} = 25V, I_D = 0.36A$ $V_{GS} = 10V, R_G = 6\Omega$	-	2.2	-	nS
t_r	Turn-on Rise Time *3		-	19.2	-	
$t_{d(off)}$	Turn-Off Delay Time *3		-	6.2	-	
t_f	Turn-Off Fall Time *3		-	23	-	
Q_G	Total Gate-Charge	$V_{DS} = 25V$	-	4	-	nC
Q_{GS}	Gate to Source Charge	$V_{GS} = 10V$	-	0.5	-	nC
Q_{GD}	Gate to Drain (Miller) Charge	$I_D = 0.2A$	-	0.4	-	nC
Source-Drain Diode Characteristics						
V_{SD}	Diode Forward Voltage *2	$I_S = 0.5A, V_{GS} = 0V$	-	0.89	1.4	V
t_{rr}	Reverse Recovery Time	$I_F = 1A, V_{GS} = 0V$	-	15	-	ns
Q_{rr}	Reverse Recovery Charge	$di_F/dt = 100A/\mu s$	-	8	-	nC



Typical Performance Characteristics ($T_A=25^\circ\text{C}$ unless otherwise Specified)

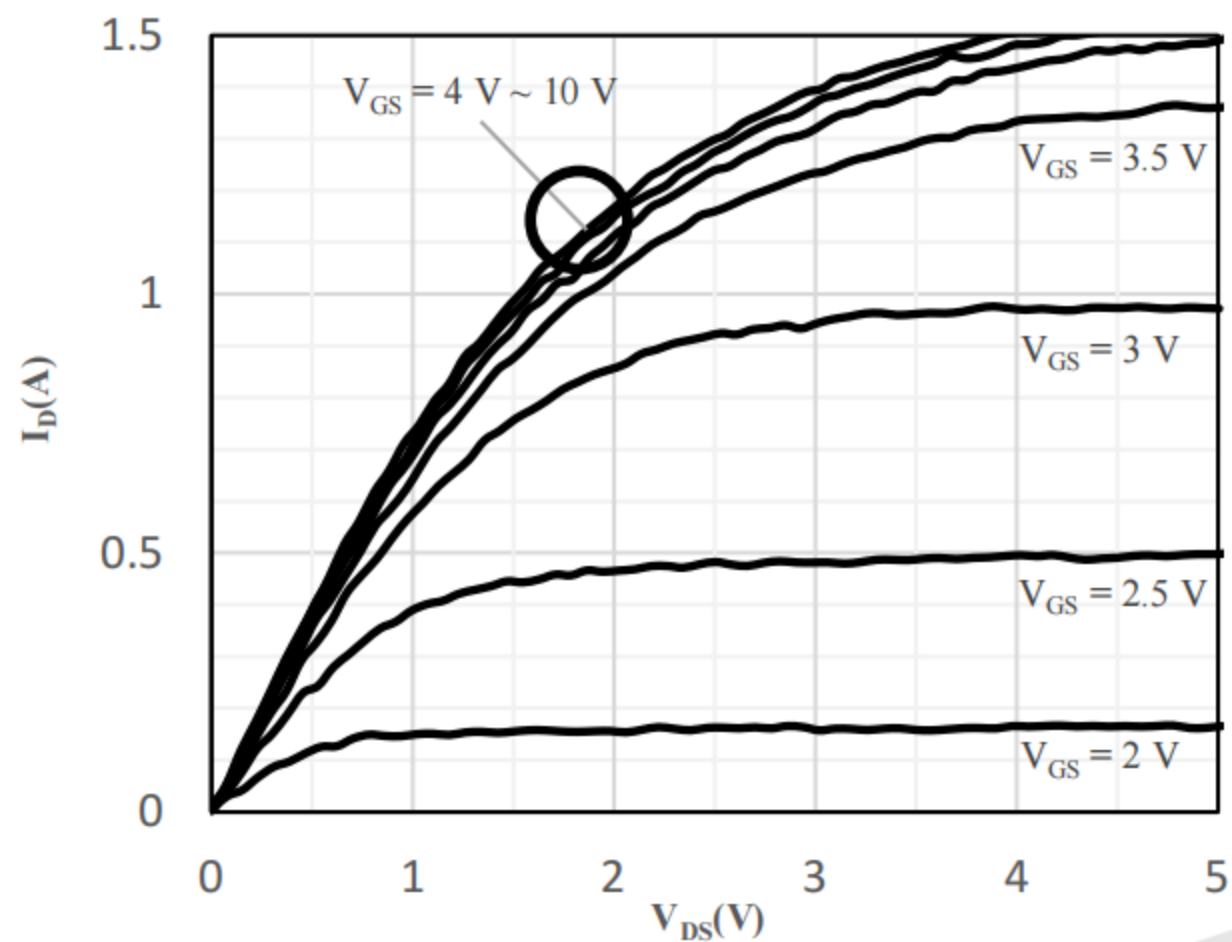

Fig 1 Typical Output Characteristics

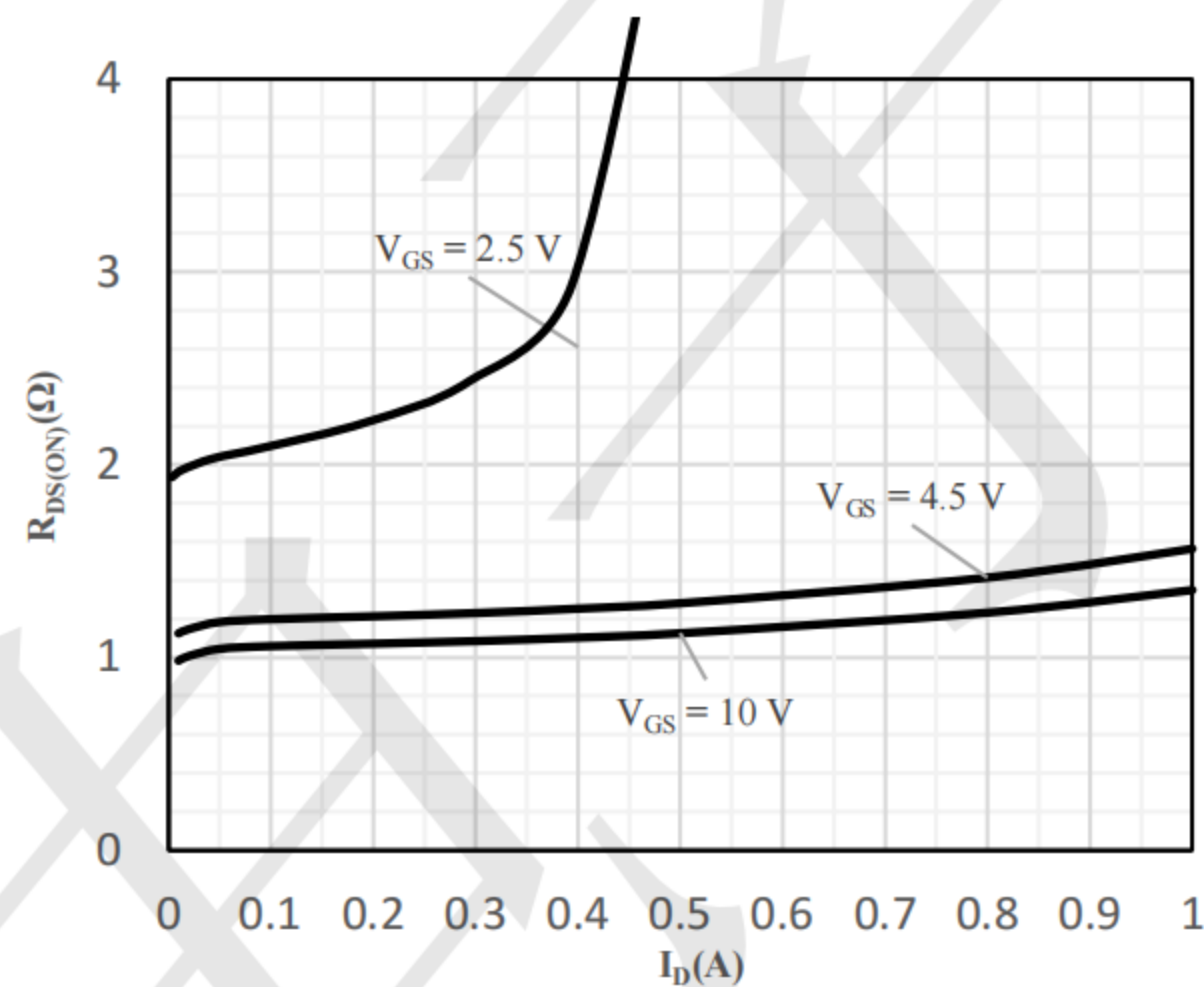

Fig 2 On-Resistance vs. Drain Current and Gate Voltage

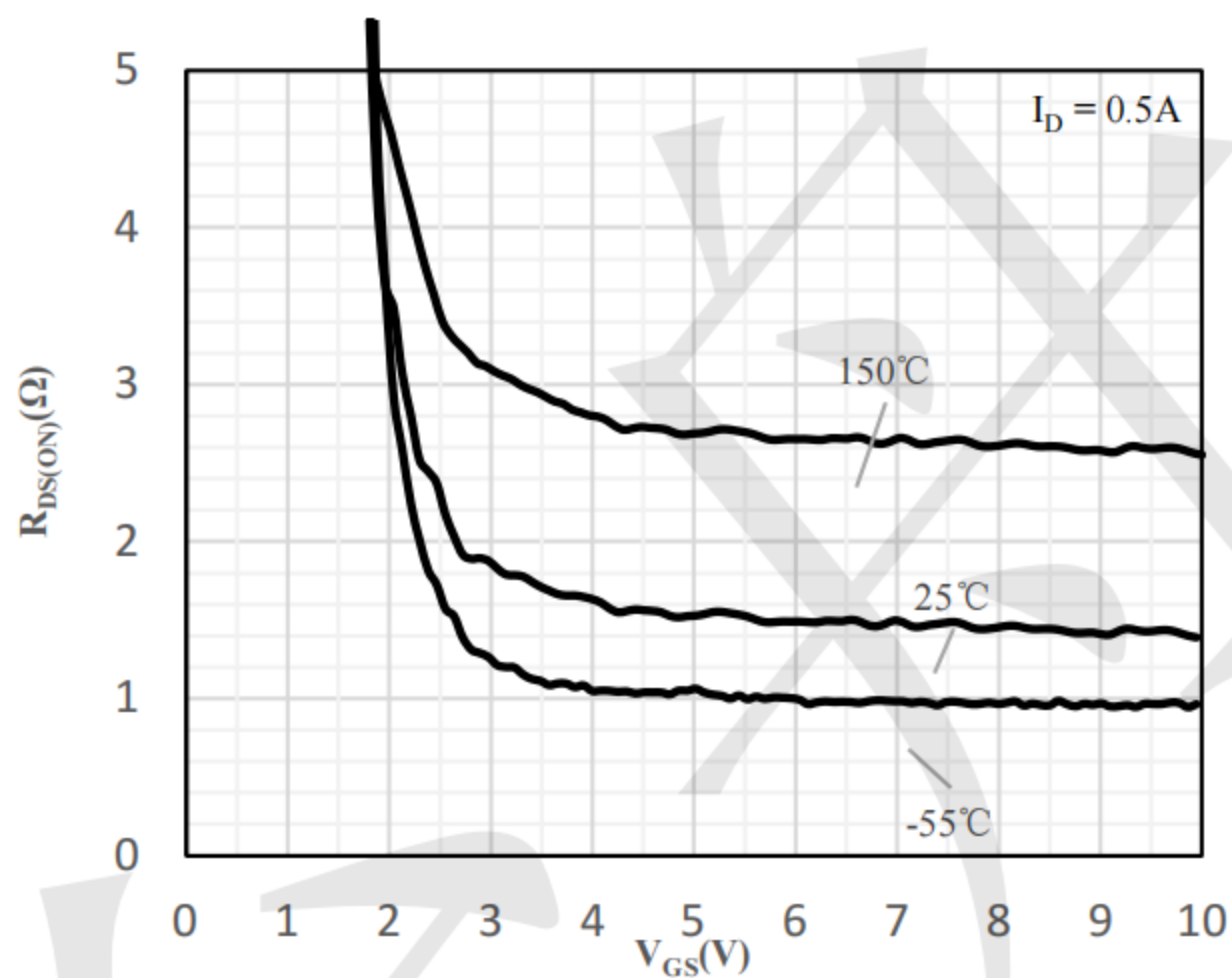

Fig 3 On-Resistance vs. Gate-Source Voltage

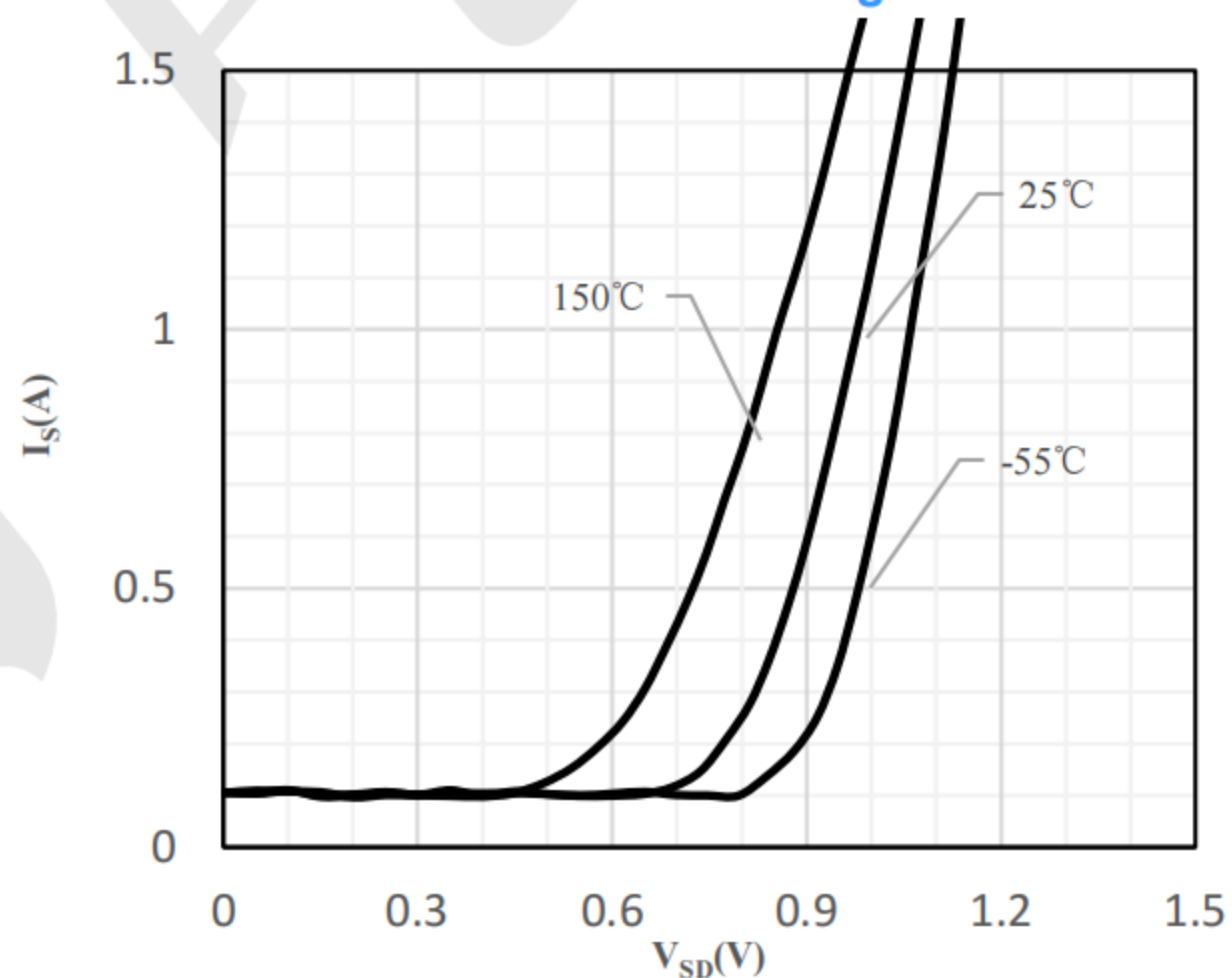

Fig 4 Body-Diode Characteristics

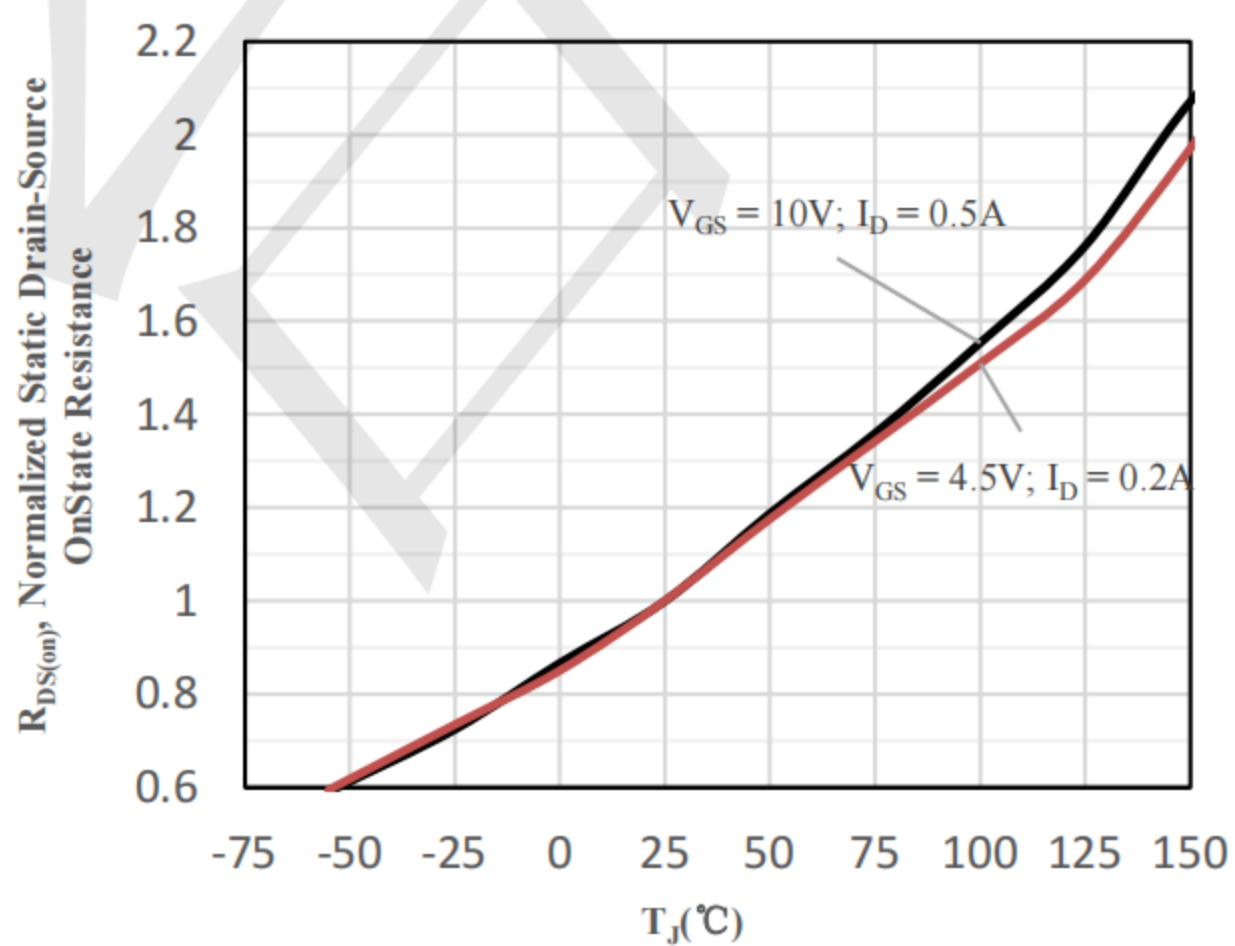

Fig 5 Normalized On-Resistance vs. Junction

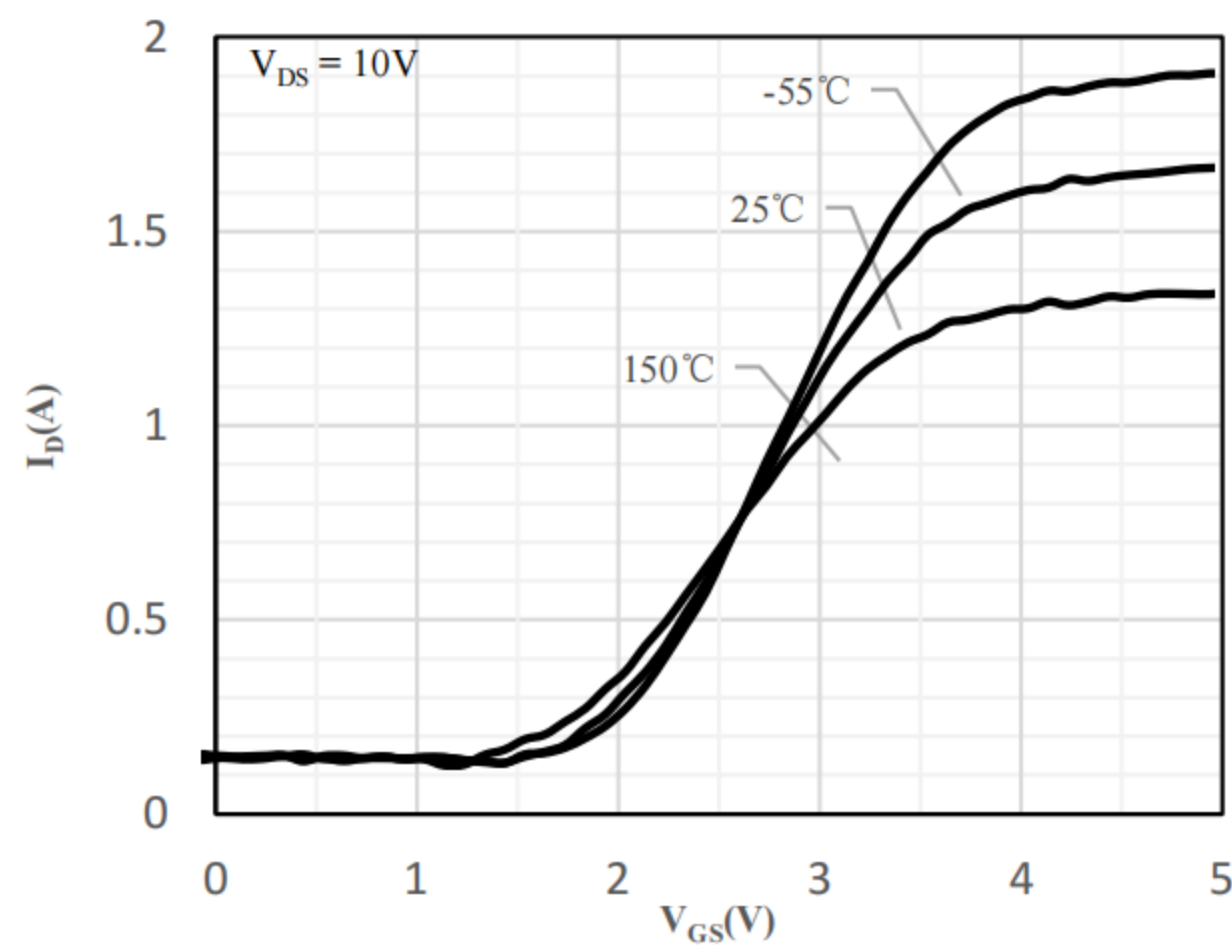

Fig 6 Transfer Characteristics



Typical Performance Characteristics ($T_A=25^\circ\text{C}$ unless otherwise Specified)

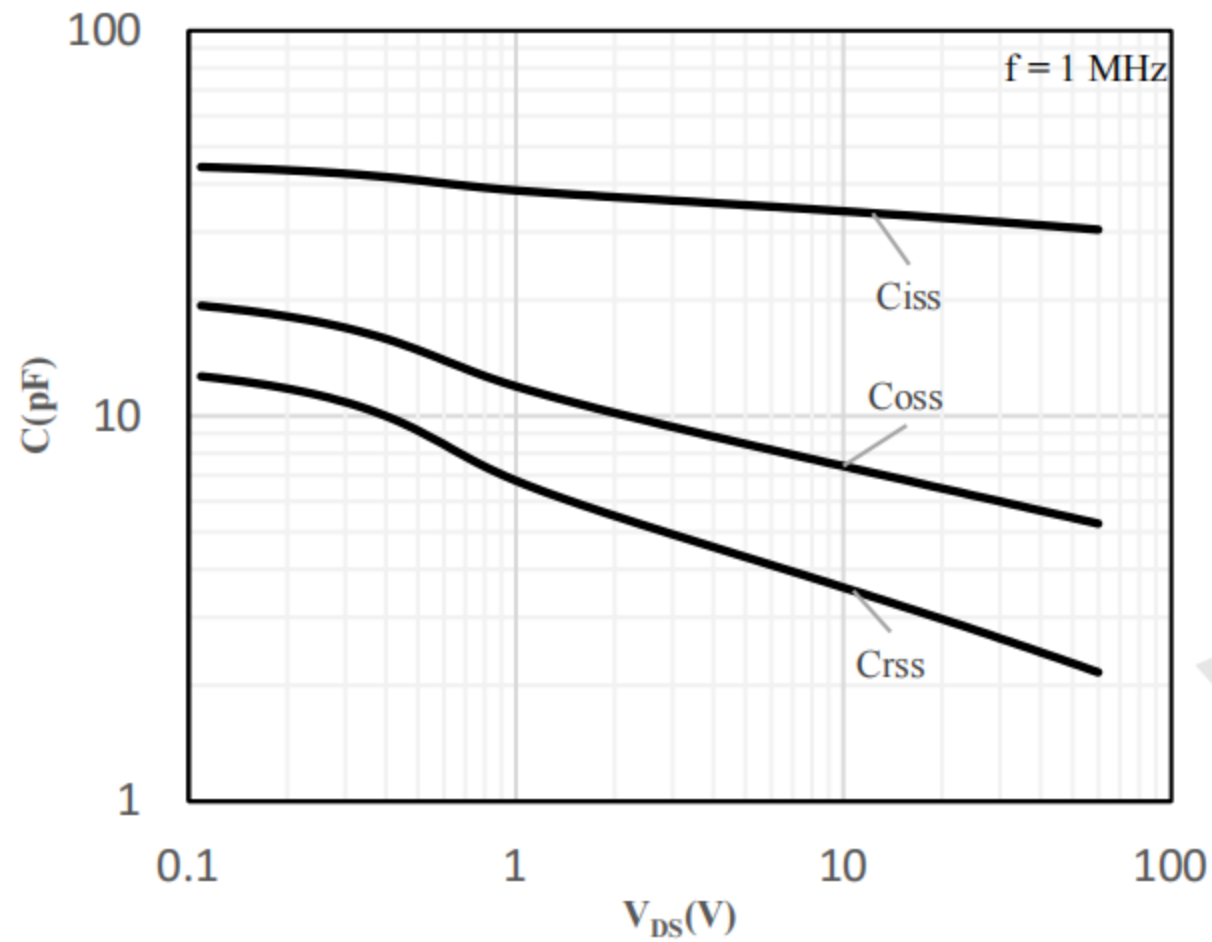

Fig 7 Capacitance Characteristics

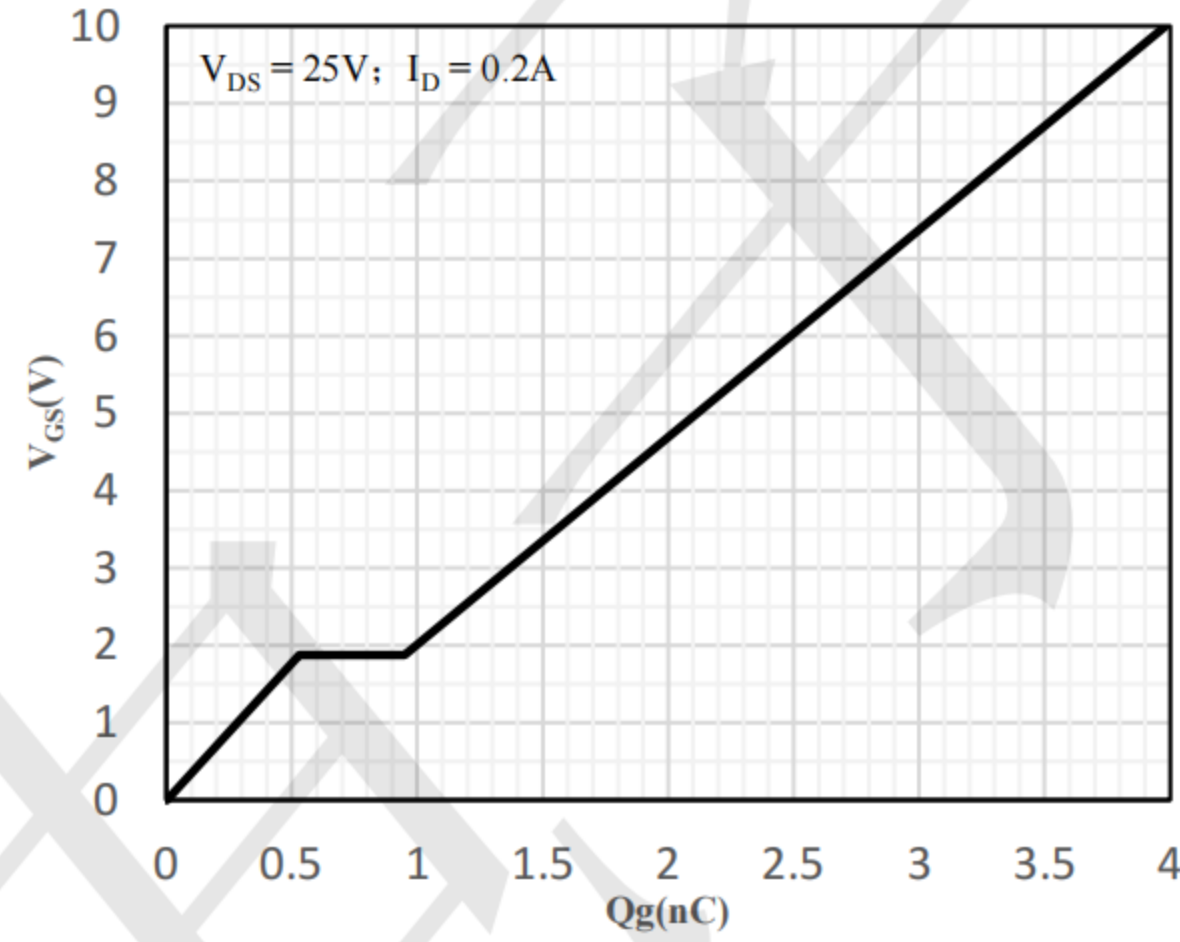

Fig 8 Gate-Charge Characteristics

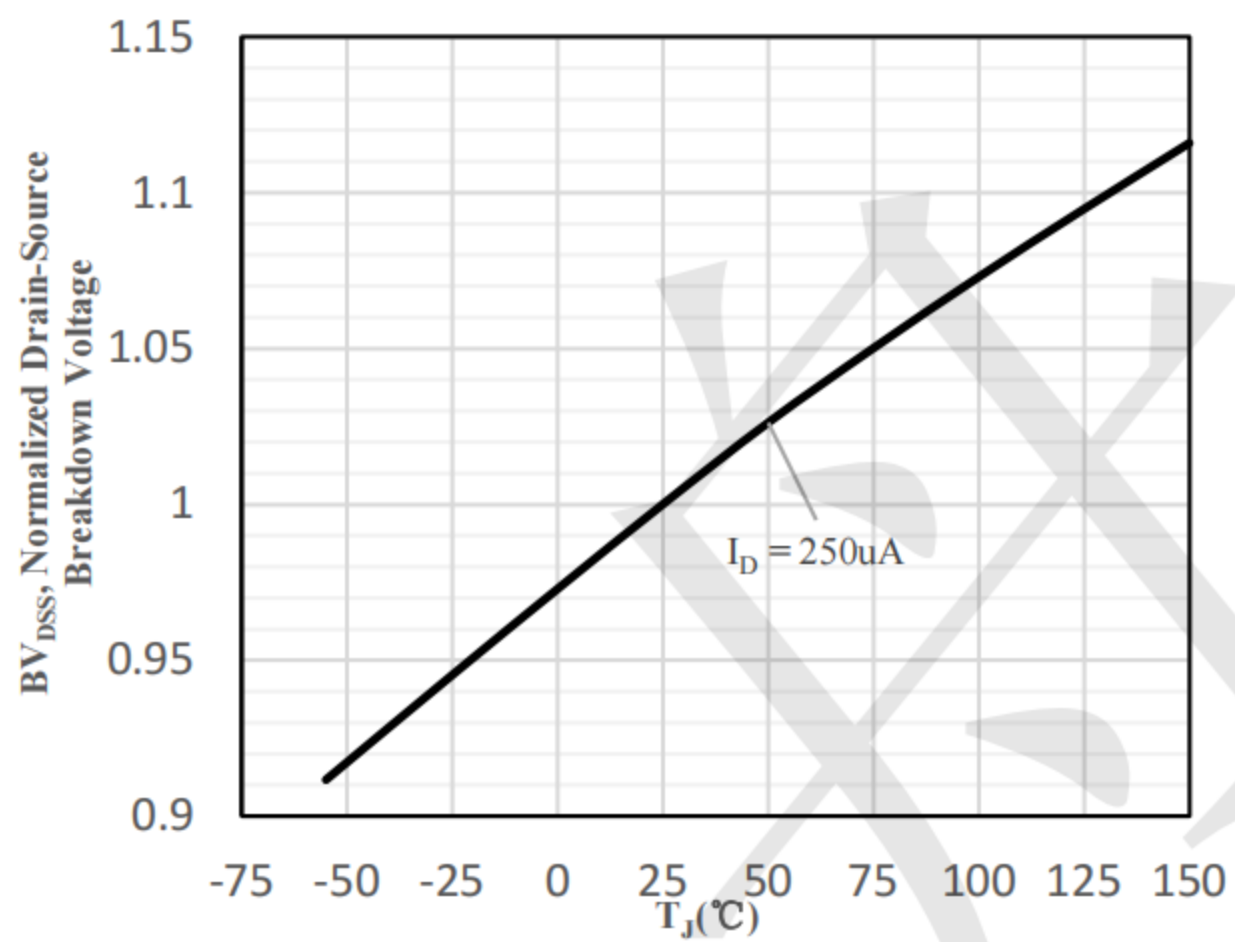

Fig 9 Normalized Breakdown Voltage vs. Junction Temperature

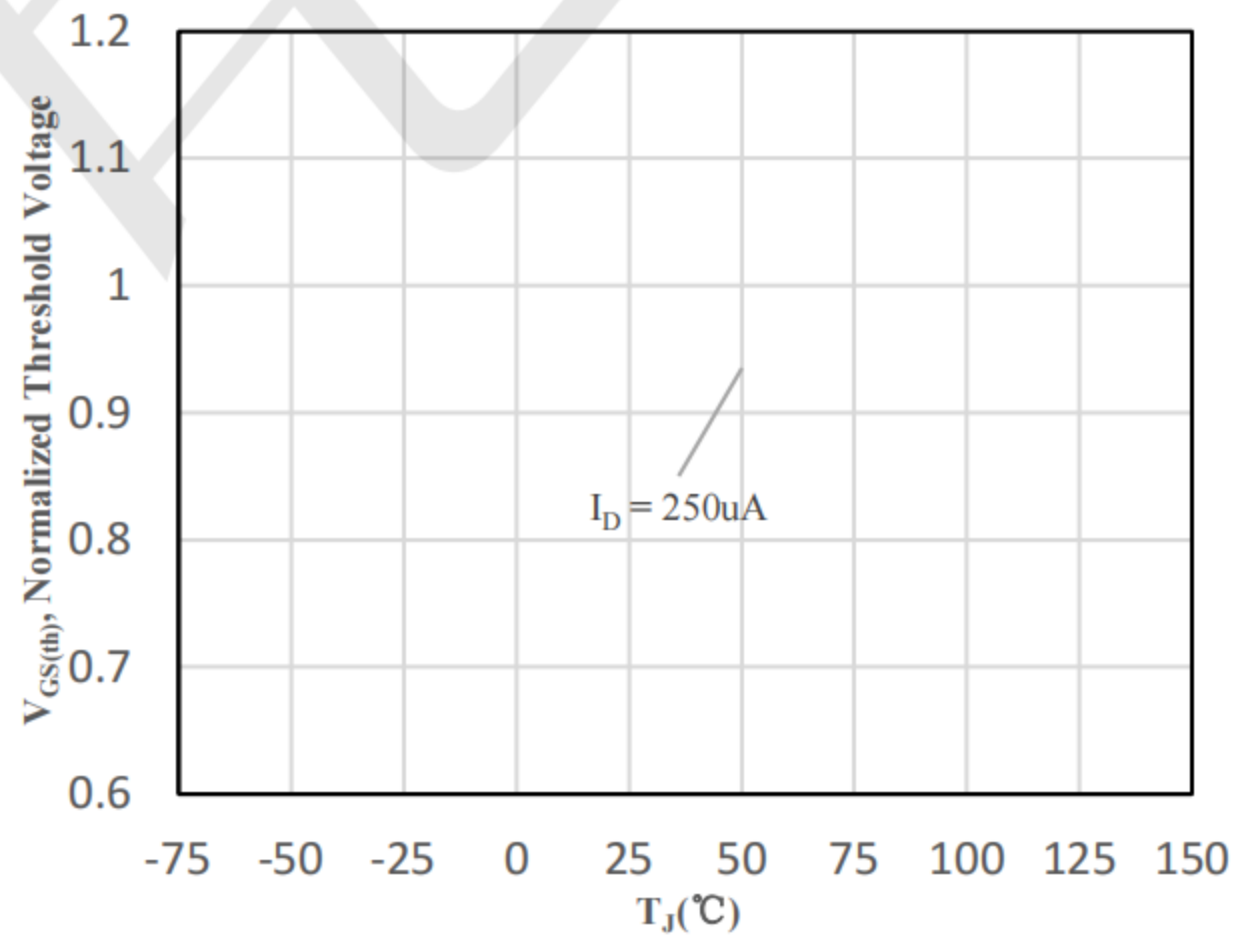

Fig 10 Normalized $V_{GS(th)}$ vs. Junction Temperature

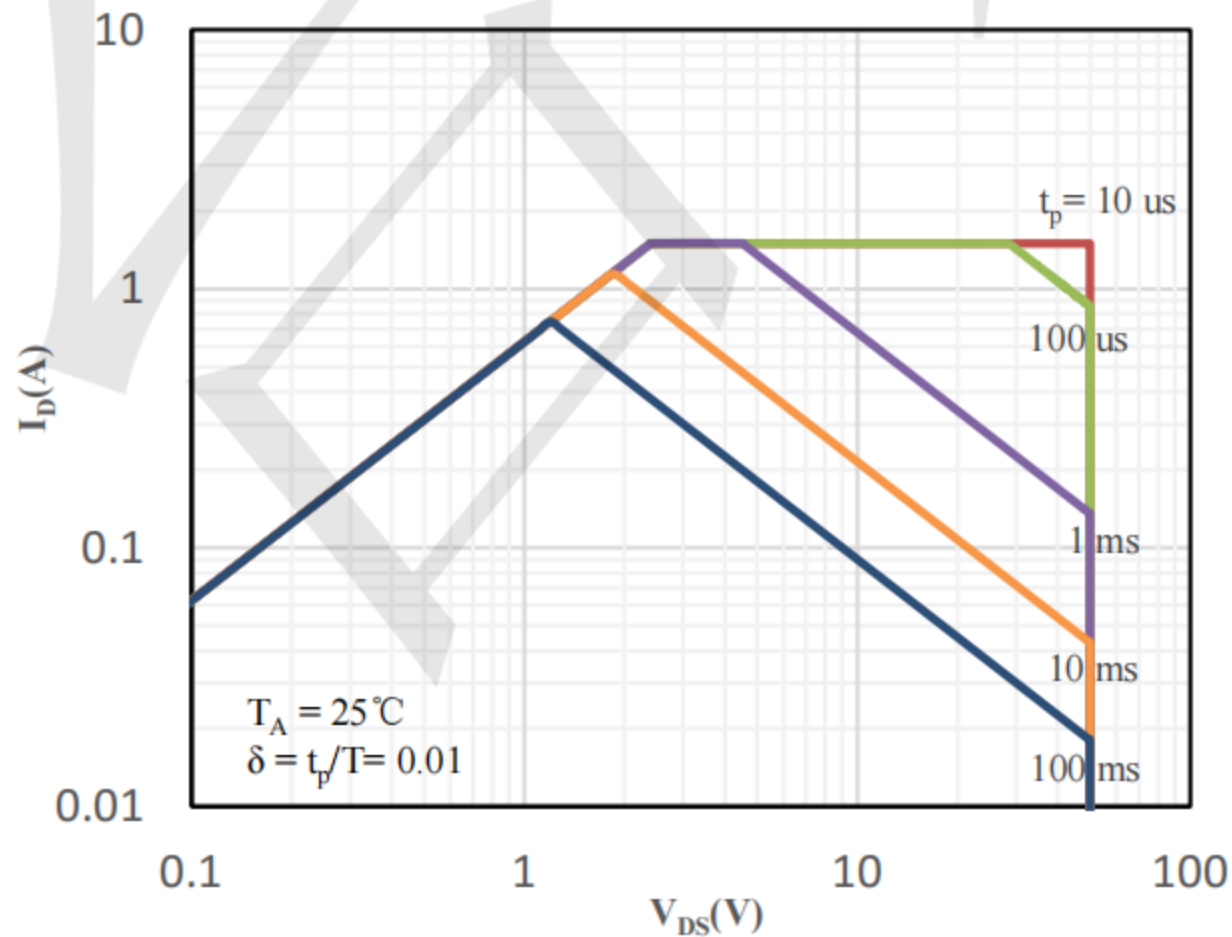

Fig 11 Safe Operation Area

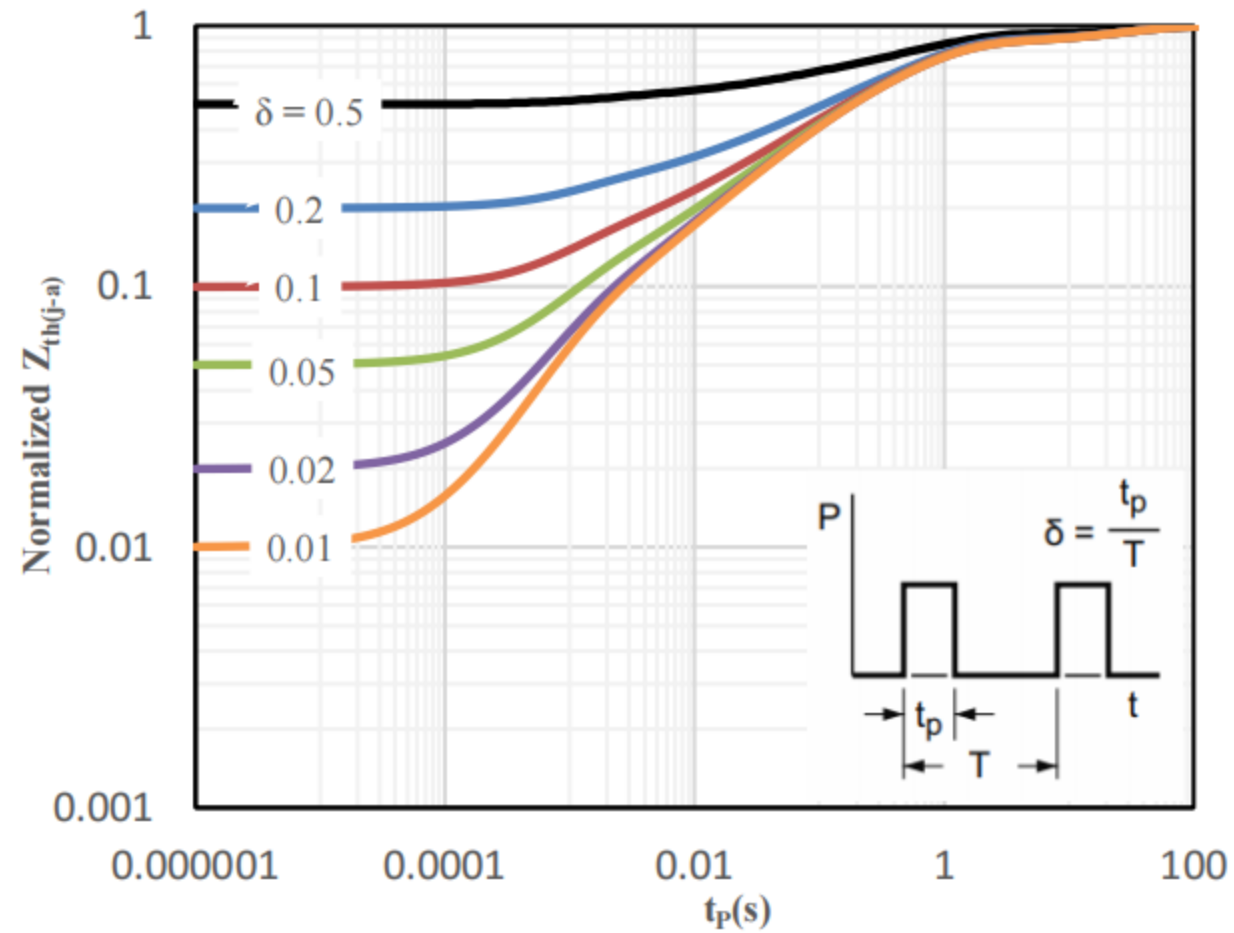
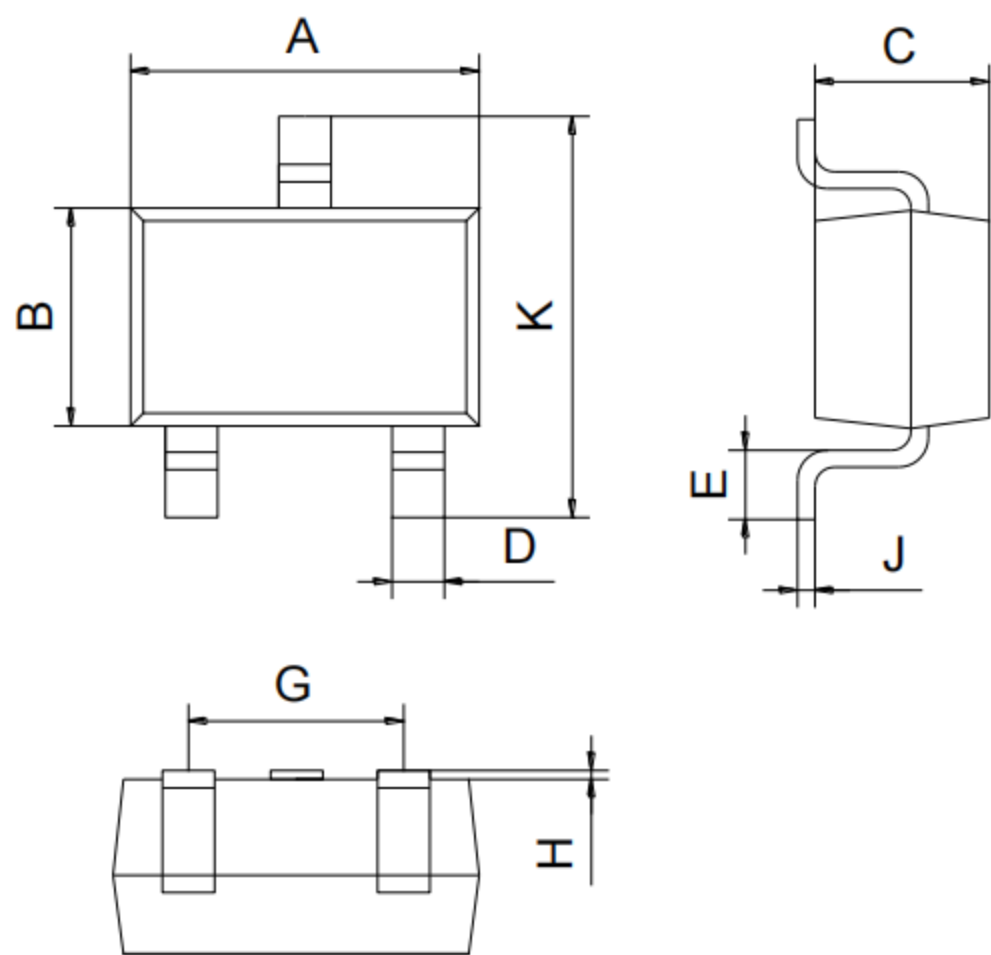

Fig 12 Normalized Maximum transient thermal impedance



Outline Drawing - SOT323(unit: mm)



SOT-323		
Dimension	Min.	Max.
A	2.00	2.20
B	1.15	1.35
C	0.90	1.10
D	0.15	0.35
E	0.25	0.40
G	1.20	1.40
H	0.02	0.10
J	0.05	0.15
K	2.20	2.40

Mounting Pad Layout-SOT323(unit: mm)

