

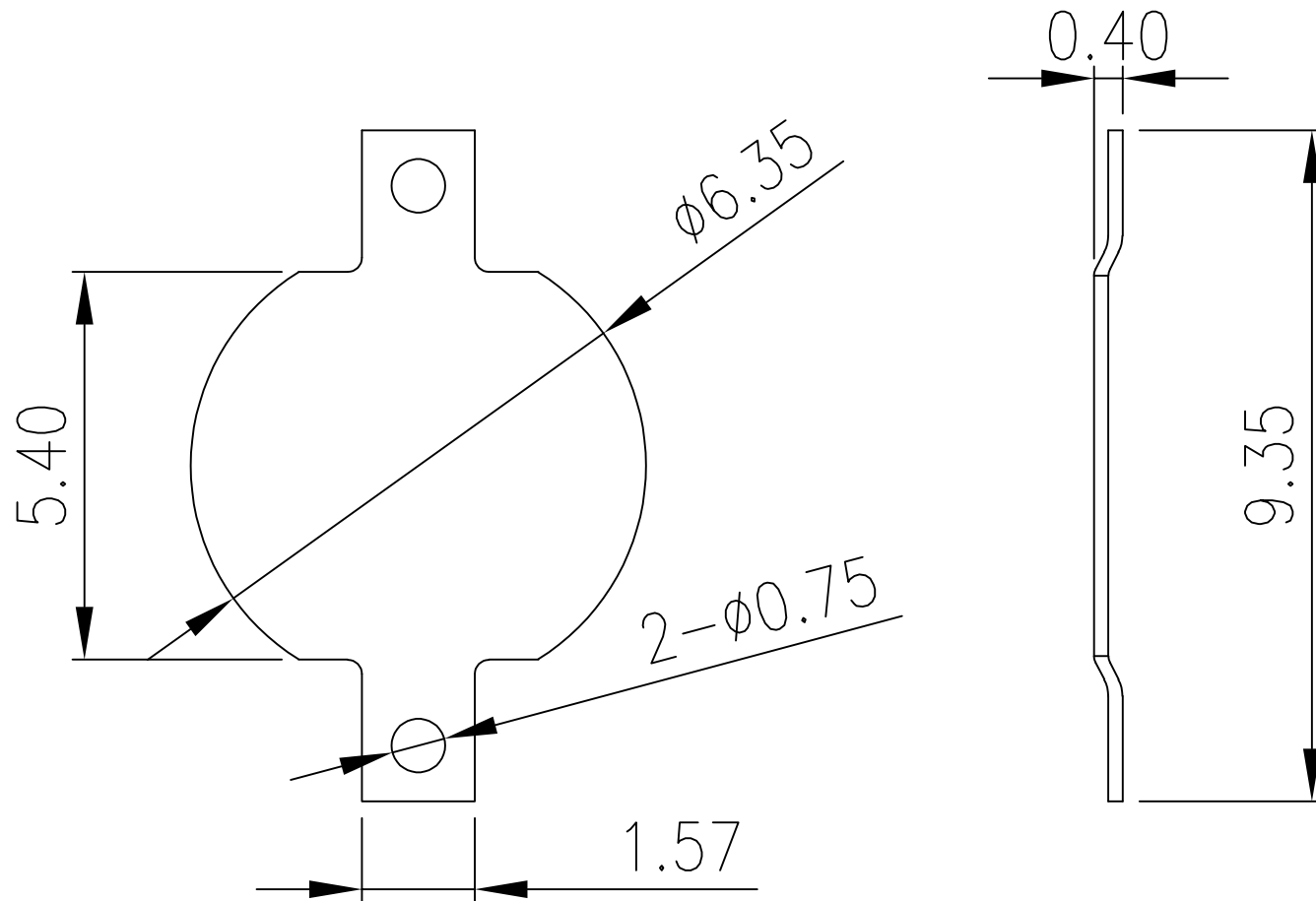

REV.	ECN NO.	REVISED	DATE



工程部
2023-07-13
H. WANG

UNLESS OTHERWISE SPECIFIED TOLERANCES		MYOUNG 美用 www.meiyangdz.com	
DECIMALS: X :±0.30 X.X :±0.25 X.XX :±0.20 X.XXX :±0.10	ANGLES: X :±1° X.X :±0.5°	DSND YangFeng	DATE 2023-07-13
WEIGHT:		CHKD ZhouRuicai	DATE 2023-07-13
SHEET 1 OF 2		APVD XueShunyong	DATE 2023-07-13
NO. PART NAME Q'TY MATERIAL PLATING & COLOR		SCALE:	SIZE: A4 VIEW:
1 TERMINAL(-) 1 BRASS, T=0.2MM Ni-Plating		UNIT: mm	REV.: A/0
		OBJECT: MY	TITLE: 纽扣电池通用负极片01 镀镍 卷装
		DRAW NO.:WD-CP-0269	PART NO.: MY-FJ-04-J-R

1	2	3	4	5	6	7	8
A	B	C	D	E	F	G	H



产品

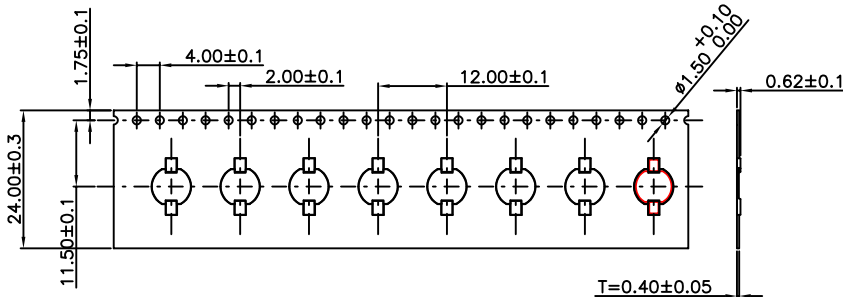
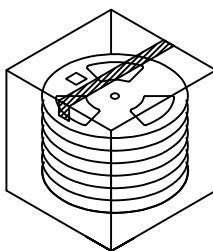
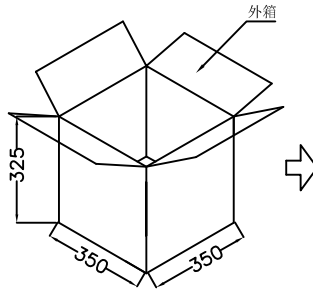
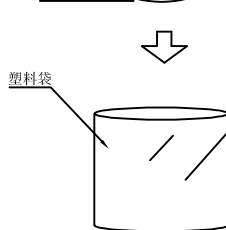
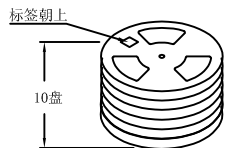
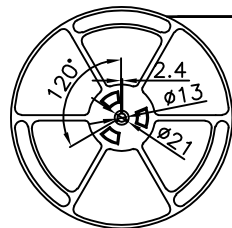
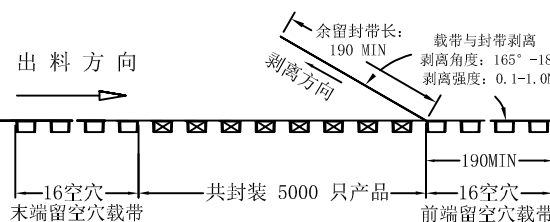
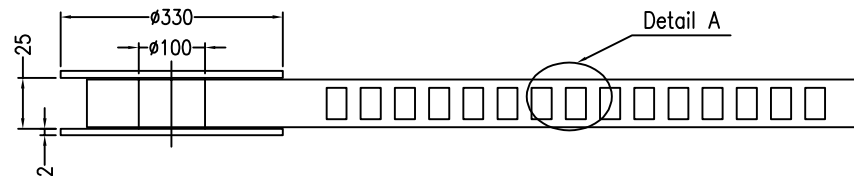
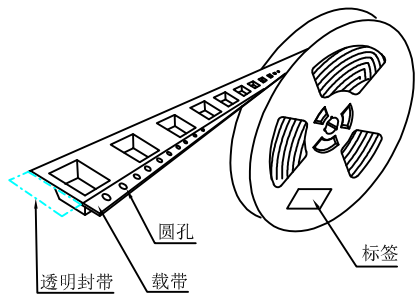

Detail A



技术要求:

1. 圆孔十个孔距离累计允许公差为 $\pm 0.2\text{mm}$
2. 带长250mm内容许弯曲度1mm
3. 材料厚度以在载带边缘测量为准
4. 所有尺寸定义依循EIA-481-C系准则定义之
5. 材料: 黑色PS T=0.4mm
6. 所有卷轮为灰蓝挖空旋转塑胶卷轮
7. 整模成型长度: 60.384M,
8. 非指明公差范围为: $\pm 0.1\text{mm}$; 超过250mm不计算累计误差
9. 型腔外形凡未标明处倒角R为0.2-0.3; 拔模斜度未标注的为 3° 以下

包装信息:

1. 每卷盘装产品 5000 只, 卷盘外侧贴相关标签;
2. 每 10 卷盘放在一个塑料袋中;
3. 每外箱装10盘, 产品总数: 50000 只;
4. 外箱上下用胶纸封成“工”字;
5. 电池座包材纽扣电池通用负极片01 卷装 (MY-FJ-04-R)

UNLESS OTHERWISE SPECIFIED TOLERANCES		MYOUNG 美阳 www.meiyangdz.com			
DECIMALS: X : ±*** X.X : ±*** X.XX : ±*** X.XXX : ±***	ANGLES: X : ±*** X.X : ±***	DSND	YangFeng	DATE	2023-07-13
		CHKD	ZhouRuicai	DATE	2023-07-13
		APVD	XueShunyong	DATE	2023-07-13
WEIGHT:		SCALE:	SIZE: A4	VIEW:	
SHEET 2 OF 2		UNIT: mm	REV.: A/0	OBJECT: MY	TITLE: 纽扣电池通用负极片01 镀镍 卷装
		PART NO.:			MY-FJ-04-J-R
		DRAW NO.:			MY-BD-0073