

# RoHS

# 客户图

目錄 MAPX	設變內容 MODIFICATION	日期 DATE
A0	NEW	09-10-20

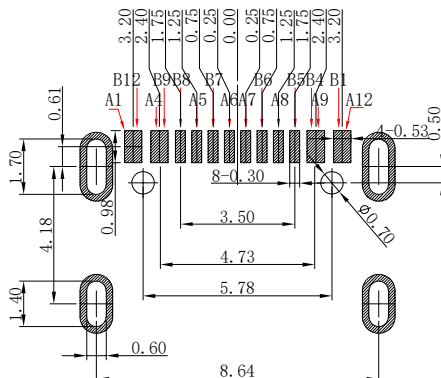
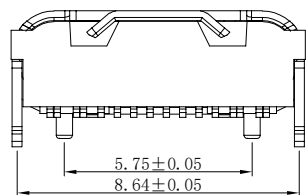

- NOTES:  
SPECIFICATION:
- CURRENT RATING: 5A MAX
  - VOLTAGE: 100 VAC
  - TEMPERATURE RANGE: -30 °C ~ 85 °C
  - CONTACT RESISTANCE: 40 MILLIONHM MAX
  - INSULATION RESISTANCE: 100 MEGOHMS MIN.
  - INSERTION FORCE : 5N~20N
  - UNMATING FORCE: 8N~20N
  - DURABILITY: 10000 CYCLES

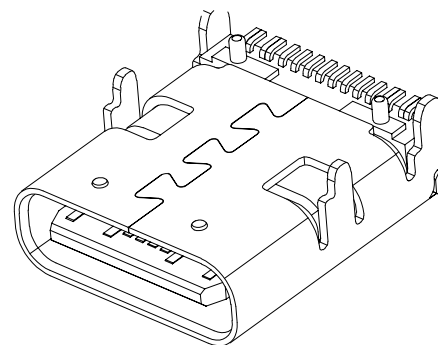
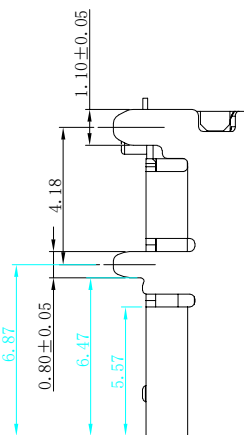
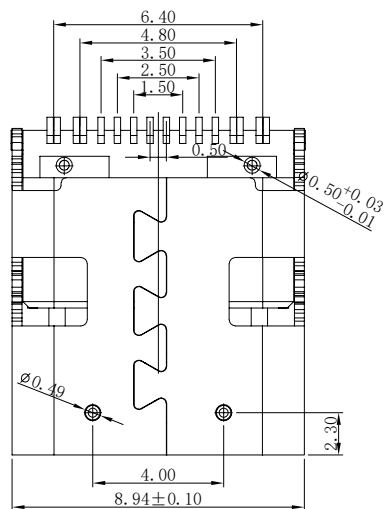
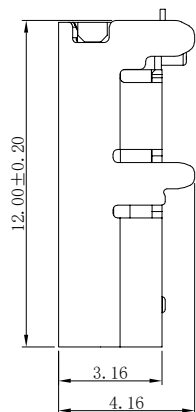

A1	GND	B12	GND
A4	VBUS	B9	VBUS
A5	CC1	B8	SBU2
A6	DP1	B7	DN2
A7	DN1	B6	DP2
A8	SBU1	B5	CC2
A9	VBUS	B4	VBUS
A12	GND	B1	GND
PIN	SIGNAL NAME	PIN	SIGNAL NAME

6	SHELL	STAINLESS STEEL	Ni/SN Plated	1PCS
5	SHIELDING PLATE	STAINLESS STEEL	---	1PCS
4	MD	HIGH TEMPERATURE PLASTIC	BLACK	1PCS
3	CONTACT	COPPER ALLOY	Au/Ni Plated	1SET
2	CONTACT	COPPER ALLOY	Au/Ni Plated	1SET
1	HOUSING	HIGH TEMPERATURE PLASTIC	BLACK	1PCS
NO.	DESCRIPTION	MATERIAL	REMARKS	QTY

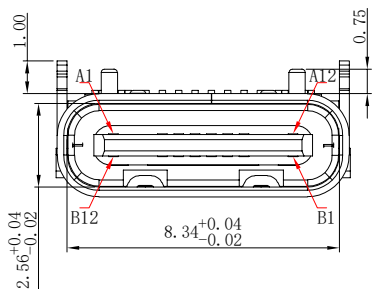

## 产品图

PRODUCT CHART DWG

# 深圳市精拓金电子有限公司

### 公差一览表

TOLERANCE UNLESS OTHERWISE

X.	±0.30	X'	±5'
.X	±0.25	.X'	±2'
.XX	±0.20	.XX'	±1'
.XXX	±0.15	.XXX'	±0.5'

单位 UNITS	MM	制图 DRAWING	林属升	产品料号 PRODUCT PART NO.	918-318K2023S40003
比例 SCALE	1:1	审核 CHKD	郭治富	产品名称 PRODUCT NO.	Type C 16p母座板上型 L=12.0
日期 DATE	2022/10/20	核准 APPD	黄国荣	联系方式 Mailbox/web	