

Description

The 3842/43/44/45 are fixed frequency current mode PWM controller. They are specially designed for OFF-Line and DC to DC converter applications with a minimal external components. Internally implemented circuits include a trimmed oscillator for precise duty cycle control, a temperature compensated reference, high gain error amplifier, current sensing comparator, and a high current totem pole output ideally suited for driving a power MOSFET. Protection circuitry includes built undervoltage lockout and current limiting. The 3842 and 3844 have UVLO thresholds of 16 V (on) and 10 V (off). The corresponding thresholds for the 3843/45 are 8.4V (on) and 7.6V (off). The 3842) and 3843 can operate within 100% duty cycle. The 3844 and 3845 can operate within 50% duty cycle.

The 384X has Start-Up Current 0.5mA (typ).

Features

- Low Start-Up and Operating Current
- High Current Totem Pole Output
- Undervoltage Lockout With Hysteresis
- Operating Frequency Up To 500KHz

Pin Connection

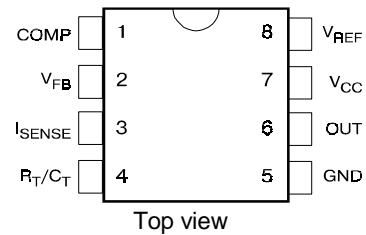

Block diagram

(toggle flip flop used only in 3844, 3845)

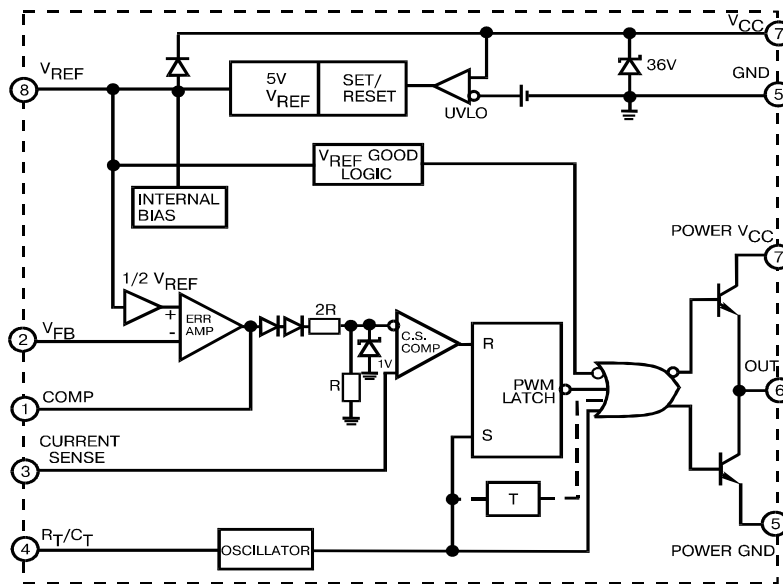

Absolute Maximum Ratings

Symbol	Parameter	Maximum	Units
V_{CC}	Supply Voltage (low impedance source)	30	V
I_o	Output Current	± 1	A
V_i	Input Voltage (Analog Inputs pins 2,3)	-0.3 to 5.5	V
$I_{SINK(E.A)}$	Error Amp Output Sink Current	10	mA
P_o	Power Dissipation ($T_A=25^\circ C$)	1	W
Tstg	Storage Temperature Range	-65 to 150	$^\circ C$
T_L	Lead Temperature (soldering 5 sec.)	260	$^\circ C$
T_A	Operating Ambient Temperature	0 to 70	$^\circ C$

Electrical characteristics

 (* $V_{CC}=15V$, $R_T=10k\Omega$, $C_T=3.3nF$, $T_A=0^\circ C$ to $+70^\circ C$, unless otherwise specified)

Characteristics	Symbol	Test Conditions	Min	Typ	Max	Units	
Reference Section							
Reference Output Voltage	V_{REF}	$T_J = 25^\circ C$, $I_{REF} = 1\text{ mA}$	4.9	5.0	5.1	V	
Line Regulation	ΔV_{REF}	$12V \leq V_{CC} \leq 25\text{ V}$		6.0	20	mV	
Load Regulation	ΔV_{REF}	$1\text{ mA} \leq I_{REF} \leq 20\text{mA}$		6.0	25		
Short Circuit Output Current	I_{SC}	$T_A = 25^\circ C$		-100	-180	mA	
Oscillator Section							
Oscillation Frequency	f	$T_J = 25^\circ C$	384X	47	50	57	KHz
			384X	47	52	57	
Frequency Change with Voltage	$\Delta f/\Delta V_{CC}$	$12V \leq V_{CC} \leq 25\text{ V}$		0.05	1.0	%	
Oscillator Amplitude	$V_{(OSC)}$	(peak to peak)		1.6		V	
Error Amplifier Section							
Input Bias Current	I_{BIAS}	$V_{FB}=3V$		-0.1	-2	μA	
Input Voltage	$V_{(I.E.A)}$	$V_{pin1} = 2.5V$	2.42	2.5	2.58	V	
Open Loop Voltage Gain	A_{VOL}	$2V \leq V_o \leq 4V$	65	90		dB	
Power Supply Rejection Ratio	PSRR	$12V \leq V_{CC} \leq 25\text{ V}$	60	70			
Output Sink Current	I_{SINK}	$V_{pin2} = 2.7V$, $V_{pin1} = 1.1V$	2	7		mA	
Output Source Current	I_{SOURCE}	$V_{pin2} = 2.3V$, $V_{pin1} = 5V$	-0.5	-1.0		mA	
High Output Voltage	V_{OH}	$V_{pin2} = 2.3V$, $R_L = 15K\Omega$ to GND	5.0	6.0		V	
Low Output Voltage	V_{OL}	$V_{pin2} = 2.7V$, $R_L = 15K\Omega$ to PIN 8		0.8	1.1		
Current Sense Section							
Gain	G_V	(Note 1 & 2)	2.85	3.0	3.15	V/V	
Maximum Input Signal	$V_{(MAX)}$	$V_{pin1} = 5V$ (Note1)	0.9	1.0	1.1	V	
Supply Voltage Rejection	SVR	$12V \leq V_{CC} \leq 25\text{ V}$ (Note 1)		70		dB	
Input Bias Current	I_{BIAS}	$V_{pin3} = 3V$		-3.0	-10	μA	
Output Section							
Low Output Voltage	V_{OL}	$I_{SINK} = 20\text{ mA}$		0.08	0.4	V	
		$I_{SINK} = 200\text{ mA}$		1.4	2.2		
High Output Voltage	V_{OH}	$I_{SINK} = 20\text{ mA}$	13	13.5		V	
		$I_{SINK} = 200\text{ mA}$	12	13.0			
Rise Time	t_r	$T_J = 25^\circ C$, $C_L = 1nF$ (Note 3)		45	150	nS	
Fall Time	t_f	$T_J = 25^\circ C$, $C_L = 1nF$ (Note 3)		35	150		
Undervoltage Lockout Section							
Start Theshold	$V_{TH(ST)}$	3842/44	14.5	16.0	17.5	V	
		3843/45	7.8	8.4	9.0		
Min. Operating Voltage (After Turn On)	$V_{OPR(min)}$	3842/44	8.5	10	11.5	V	
		3843/45	7.0	7.6	8.2		
PWM Section							
Max. Duty Cycle	$D_{(MAX)}$	3842/43	95	97	100	%	
		3844/45	47	48	50		
Min. Duty Cycle	$D_{(MAX)}$				0		
Total Standby Current							
Start-Up Current	I_{ST}	384X		0.5		mA	
Operating Supply Current	$I_{CC (OPR)}$	$V_{pin3} = V_{pin2} = 0V$		13	17		
Zener Voltage	V_Z	$I_{CC}=25\text{ mA}$	30	38		V	

 * - Adjust V_{CC} above the start threshold before setting it to 15V.

 Note 1: Parameter measured at trip point of latch with $V_{pin2}=0$.

 Note 2: Gain defined as $A=\Delta V_{pin1}/\Delta V_{pin3}$; $0 \leq V_{pin3} \leq 0.8V$.

Note 3: These parameters, although guaranteed, are not 100% tested in production.

Pin functions

N	Function	Description
1	COMP	This pin is the Error Amplifier output and is made for loop compensation.
2	V _{FB}	This is the inverting input of the Error Amplifier. It is normally connected to the switching power supply output through a resistor divider.
3	I _{SENSE}	A voltage proportional to inductor current is connected to this input. The PWM uses this information to terminate the output switch conduction.
4	R _T /C _T	The oscillator frequency and maximum Output duty cycle are programmed by connecting resistor R _T to V _{ref} and capacitor C _T to ground.
5	GROUND	This pin is the combined control circuitry and power ground.
6	OUTPUT	This output directly drives the gate of a power MOSFET. Peak currents up to 1A are sourced and sink by this pin.
7	V _{CC}	This pin is the positive supply of the integrated circuit.
8	V _{ref}	This is the reference output. It provides charging current for capacitor C _T through resistor R _T .

Application information

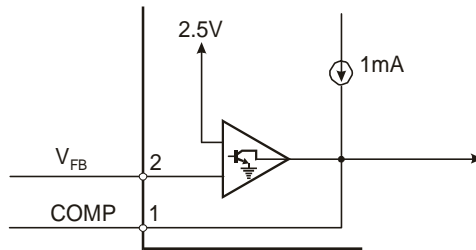

Figure 1. Error Amp Configuration

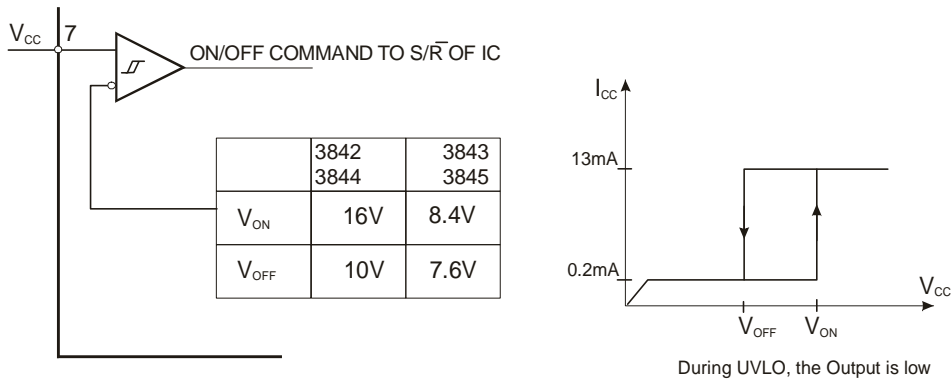

Figure 2. Undervoltage Lockout

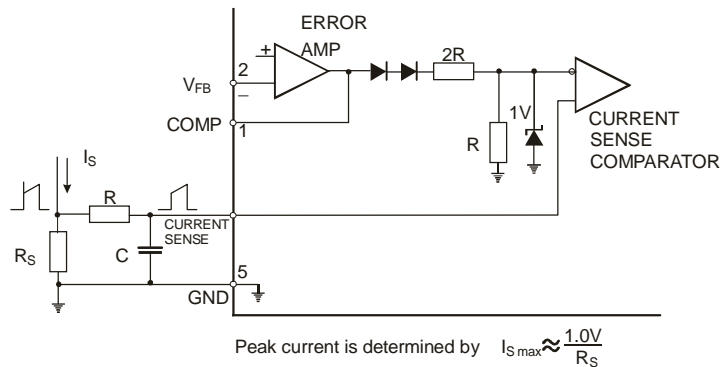

Figure 3. Current Sense Circuit

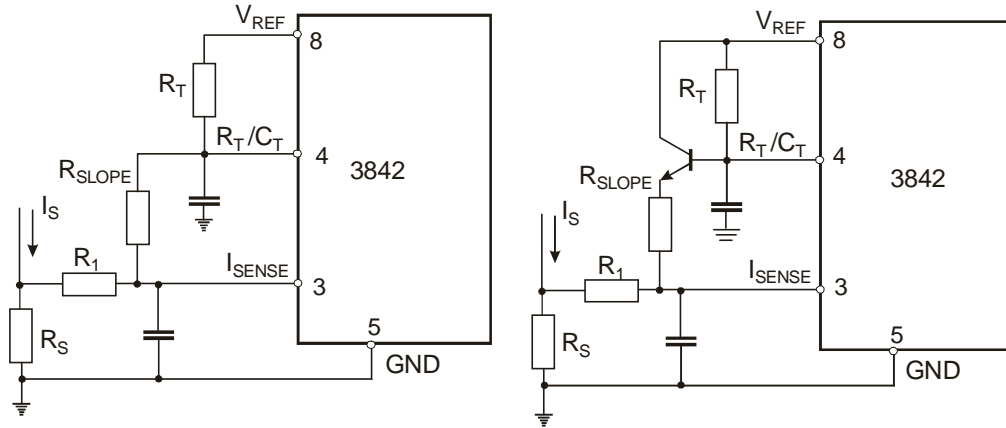
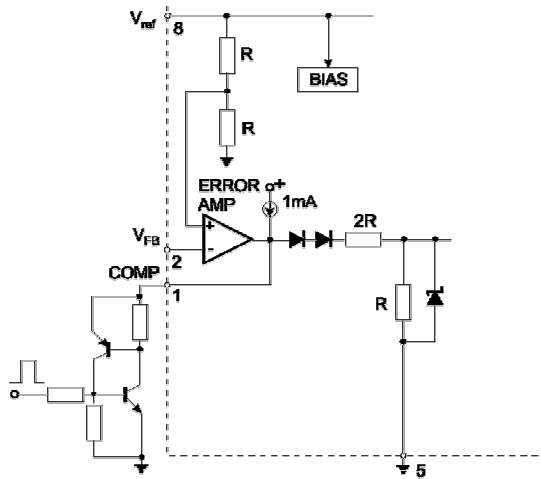
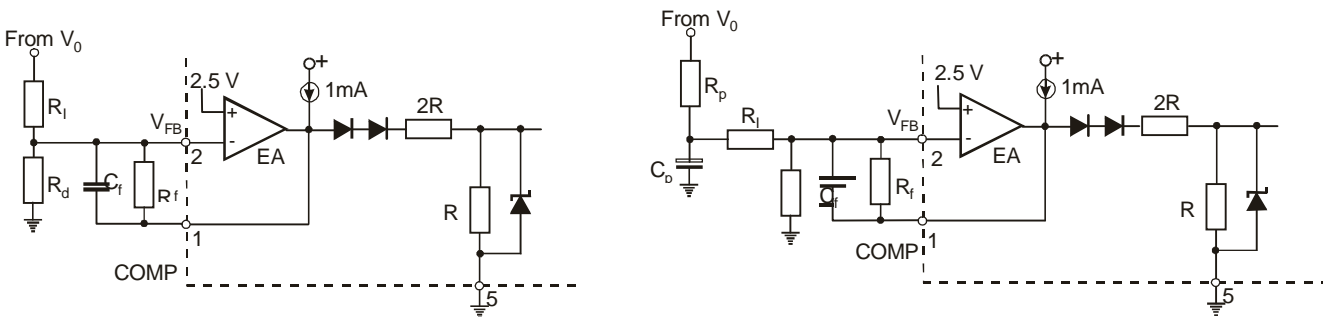

Figure 4. Slope Compensation Techniques



SCR must be selected for a holding current of less than 0.5mA.
The simple two transistor circuit can be used in place of the SCR as shown.

Figure 5. Latched Shutdown



Error Amp compensation circuit for stabilizing any current-mode topology except for boost and flyback converters operating with continuous inductor current.

Error Amp compensation circuit for stabilizing current-mode boost and flyback topologies operating with continuous inductor current.

Figure 6. Error Amplifier Compensation

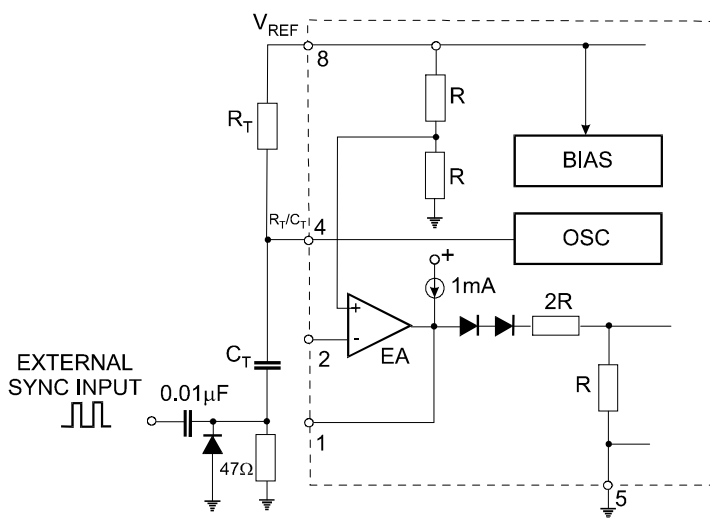

Figure 7. External Clock Synchronization

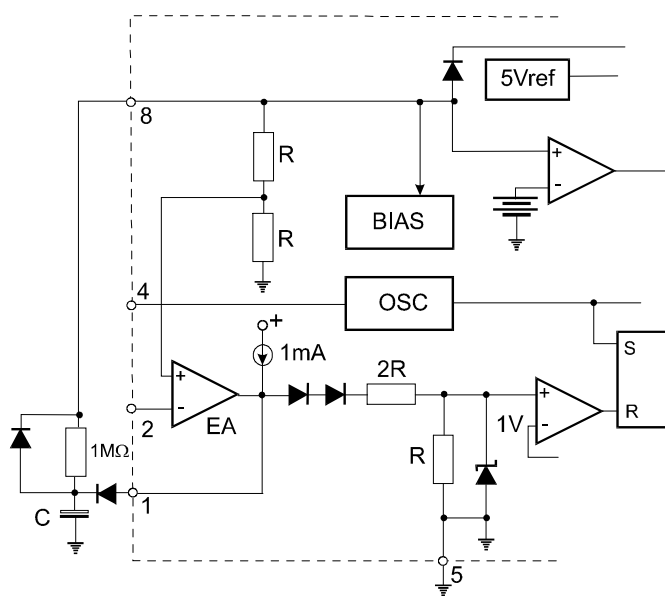

Figure 8. Soft-Start Circuit

Typical Performance Characteristics

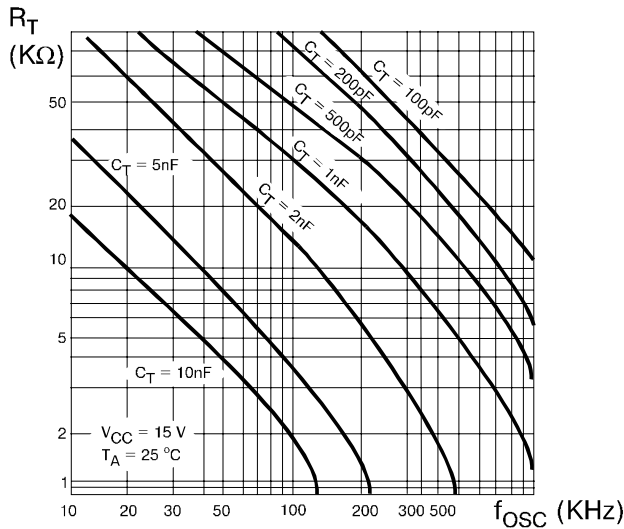

Figure 1. Timing Resistor vs. Oscillator Frequency

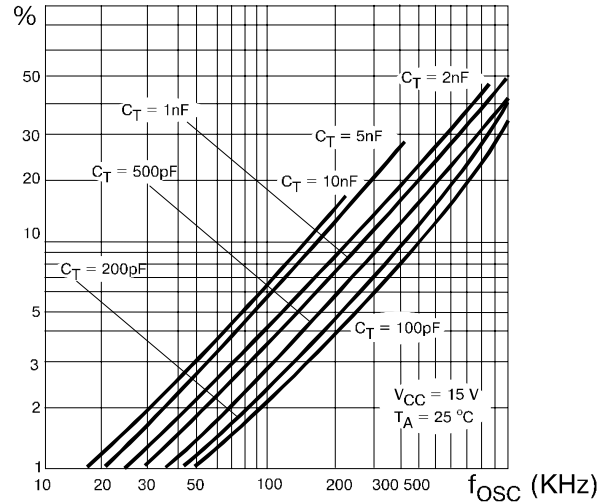

Figure 2. Output Dead-Time vs. Oscillator Frequency

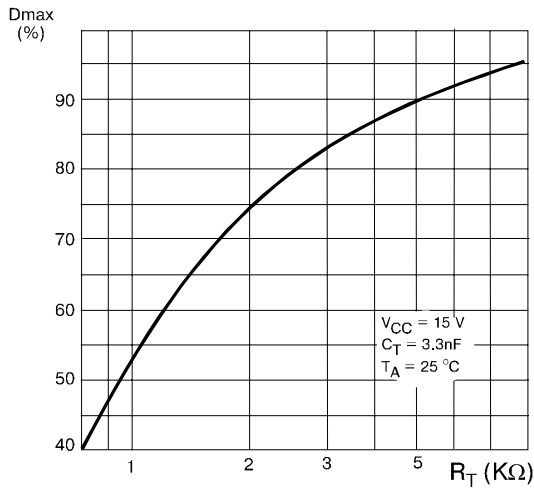

Figure 3. Maximum Output Duty Cycle vs. Timing Resistor (UC3842/43)

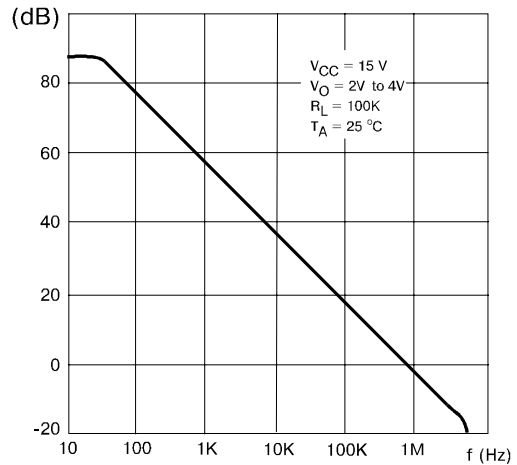

Figure 4. Error Amp Open-Loop Gain vs. Frequency

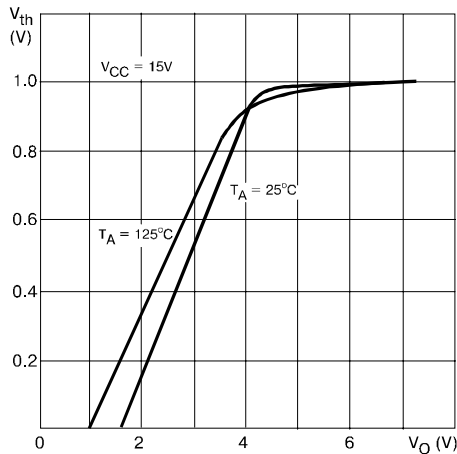

Figure 5. Current Sense Input Threshold vs. Error Amp Output Voltage

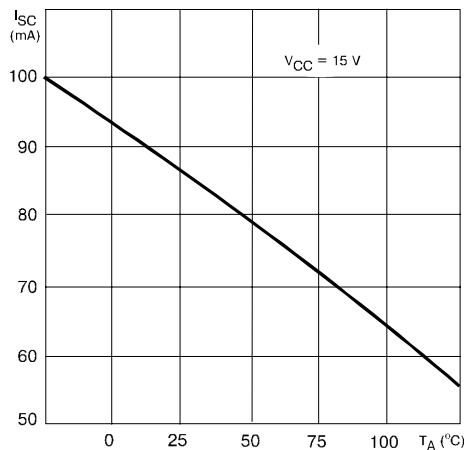

Figure 6. Reference Short Circuit Current vs. Temperature

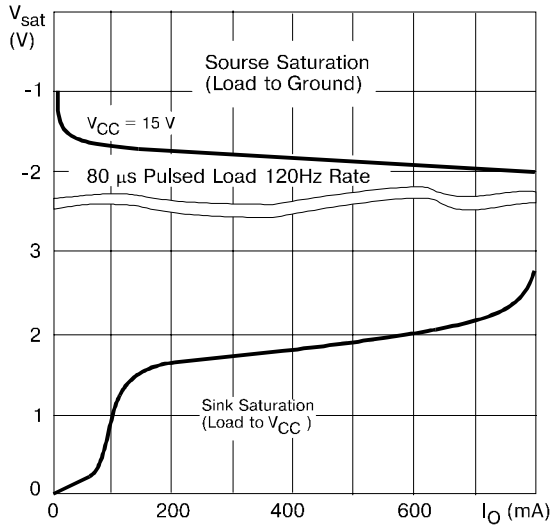

Figure 7. Output Saturation Voltage vs. Load Current
 $T_A = 25^\circ\text{C}$

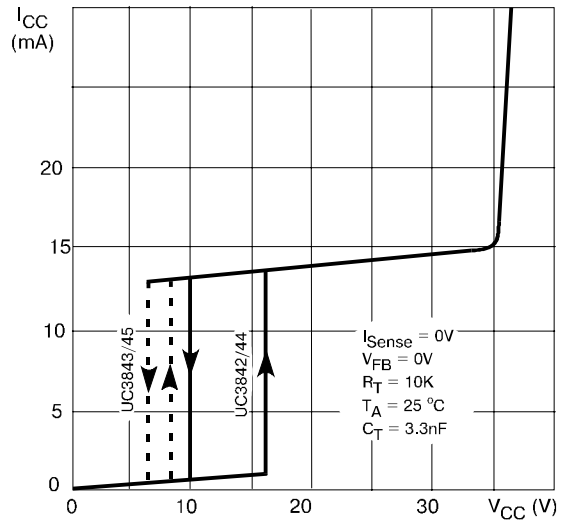

Figure 8. Supply Current vs. Supply Voltage

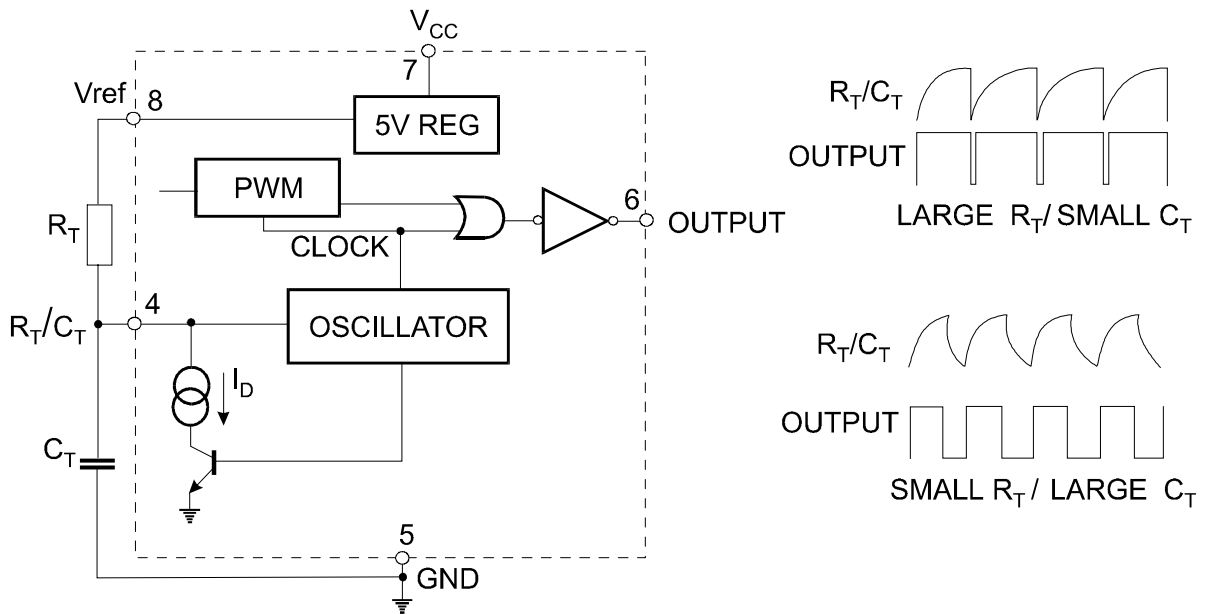

Figure 9. Oscillator and Output Waveforms

Ordering information

Order code	Package	Baseqty	Deliverymode
UMW UC3842B	SOP-8	2500	Tape and reel
UMW UC3843B	SOP-8	2500	Tape and reel
UMW UC3844B	SOP-8	2500	Tape and reel
UMW UC3845B	SOP-8	2500	Tape and reel