

Features

- V_{DS} (V)=600V
- I_D=4.0A
- R_{DS(ON)} ≤ 2.4 Ω (V_{GS} = 10V)

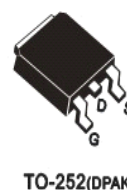
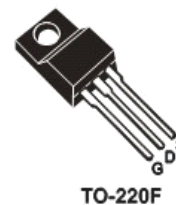
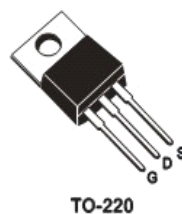

●最大额定值 (T_c=25°C)

●Absolute Maximum Ratings (T_c=25°C) TO-220/220F/TO-252

参数 PARAMETER	符号 SYMBOL	额定值 VALUE	单位 UNIT
漏-源电压 Drain-source Voltage	V _{DS}	600	V
栅-源电压 gate-source Voltage	V _{GS}	± 30	V
漏极电流 Continuous Drain Current TC=25°C	I _D	4.0	A
漏极电流 Continuous Drain Current TC=100°C	I _D	2.5	A
最大脉冲电流 Drain Current — Pulsed ①	I _{DM}	16	A
耗散功率 Power Dissipation	P _{tot}	TO-220:104	W
		TO-220F:36	
最高结温 Junction Temperature	T _J	150	°C
存储温度 Storage Temperature	T _{STG}	-55-150	°C
单脉冲雪崩能量 Single Pulse Avalanche Energy②	E _{AS}	128	mJ

●电特性 (Tc=25°C)

●Electronic Characteristics (Tc=25°C)

参数 PARAMETER	符号 SYMBOL	测试条件 TEST CONDITION	最小值 MIN	典型值 TYP	最大值 MAX	单位 UNIT
漏-源击穿电压 Drain-source Breakdown Voltage	BV _{DSS}	V _{GS} =0V, I _D =250μA	600			V
击穿电压温度系数 Breakdown Voltage Temperature Coefficient	$\Delta BV_{DSS} / \Delta T_j$	I _D =250uA, Referenced to 25°C		0.6		V/°C
栅极开启电压 Gate Threshold Voltage	V _{GS(TH)}	V _{GS} =V _{DS} , I _D =250μA	2.0		4.0	V
漏-源漏电流 Drain-source Leakage Current	I _{DSS}	V _{DS} =600V, V _{GS} =0V, T _j =25°C			25	μA
		V _{DS} =480V, V _{GS} =0V, T _j =125°C			250	μA
跨导 Forward Transconductance	g _{fs}	V _{DS} =40V, I _D =2.0A ③		2.5		S

参数 PARAMETER	符号 SYMBOL	测试条件 TEST CONDITION	最小值 MIN	典型值 TYP	最大值 MAX	单位 UNIT
栅极漏电流 Gate-body Leakage Current ($V_{DS} = 0$)	I_{GSS}	$V_{GS} = \pm 30V$			± 100	nA
漏-源导通电阻 Static Drain-source On Resistance	$R_{DS(ON)}$	$V_{GS} = 10V, I_D = 2.0A$ ③		2.00	2.4	Ω
输入电容 Input Capacitance	C_{iss}	$V_{GS} = 0V, V_{DS} = 25V$ $F = 1.0MHz$		580		pF
关断延迟 Turn -Off Delay Time	$T_d(off)$	$V_{DD} = 300V, I_D = 4.0A$ $R_G = 25\Omega$ ③		20		ns
栅极电荷 Total Gate Charge	Q_g	$I_D = 4.0A, V_{DS} = 480V$ $V_{GS} = 10V$ ③		14.8		nC
栅源电荷 Gate-to-Source Charge	Q_{gs}			3.4		nC
栅漏电荷 Gate-to-Drain Charge	Q_{gd}			4.8		nC
二极管正向电流 Continuous Diode Forward Current	I_S				4.0	A
二极管正向压降 Diode Forward Voltage	V_{SD}	$T_j = 25^\circ C, I_S = 4.0A$ $V_{GS} = 0V$ ③			1.4	V
反向恢复时间 Reverse Recovery Time	t_{rr}	$T_j = 25^\circ C, I_f = 4.0A$ $di/dt = 100A/\mu s$ ③		390		ns
反向恢复电荷 Reverse Recovery Charge	Q_{rr}			1.5		μC

●热特性
●Thermal Characteristics

参数 PARAMETER	符号 SYMBOL	最大值 MAX			单位 UNIT
		TO-220	TO-220F		
热阻结-壳 Thermal Resistance Junction-case	R_{thJC}	1.20	3.47		$^\circ C/W$
热阻结-环境 Thermal Resistance Junction-ambient	R_{thJA}	62.5	62.5		$^\circ C/W$

注释(Notes):

- ① 脉冲宽度：以最高结温为限制
Repetitive rating: Pulse width limited by maximum junction temperature
- ② 初始结温= $25^\circ C$, $V_{DD} = 50V$, $L = 25mH$, $R_G = 25\Omega$, $I_{AS} = 4.0A$
Starting $T_j = 25^\circ C$, $V_{DD} = 50V$, $L = 25mH$, $R_G = 25\Omega$, $I_{AS} = 4.0A$
- ③ 脉冲测试：脉冲宽度 $\leq 300\mu s$ ，占空比 $\leq 2\%$
Pulse Test : Pulse width $\leq 300\mu s$, Duty cycle $\leq 2\%$

● 特性曲线



图 1 输出特性曲线, Tc=25°C

Fig1 Typical Output Characteristics, Tc=25°C

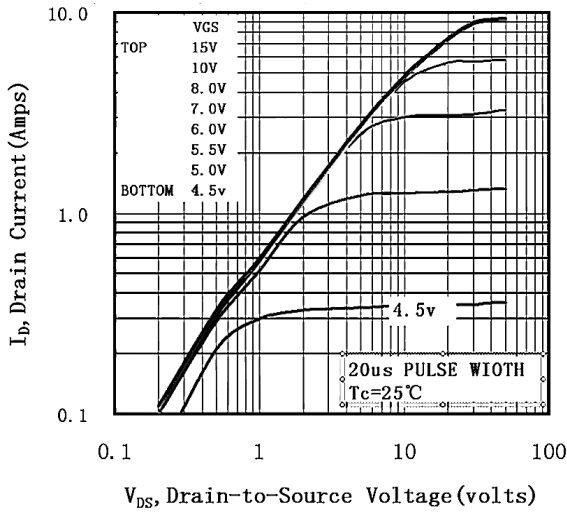

图 2 输出特性曲线, Tc=150°C

Fig2 Typical Output Characteristics, Tc=150°C

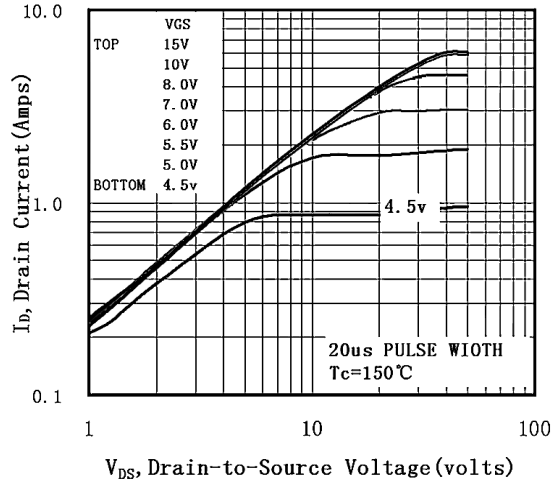

图 3 归一化导通电阻与温度曲线

Fig3 Normalized Resistance Vs. Temperature

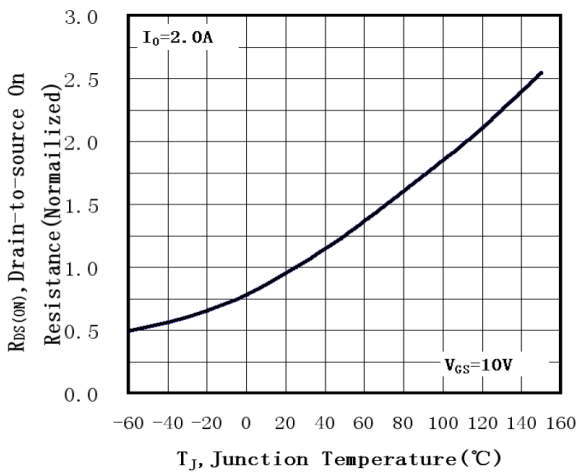

图 4 二极管正向电压曲线

Fig4 Typical Source-Drain Diode Forward Voltage

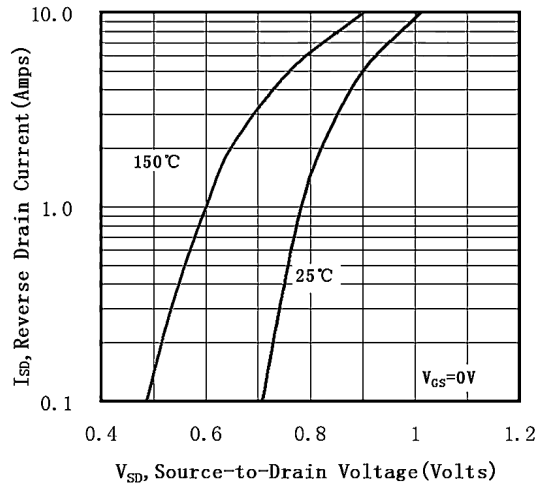

图 5 最大漏极电流与壳温曲线

Fig5 Maximum Drain Current Vs. Case Temperature

● 特性曲线

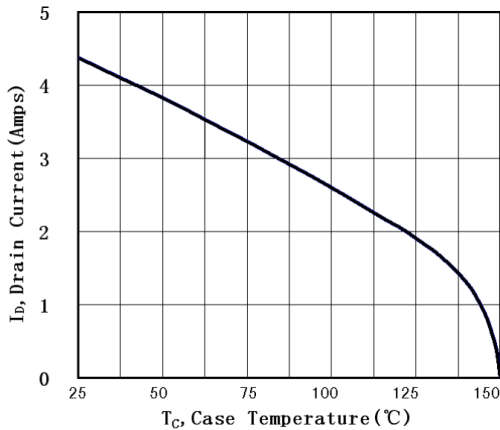

图 6-1 4N60 (TO-220)

最大安全工作区曲线

Fig6-1 Maximum Safe Operating Area

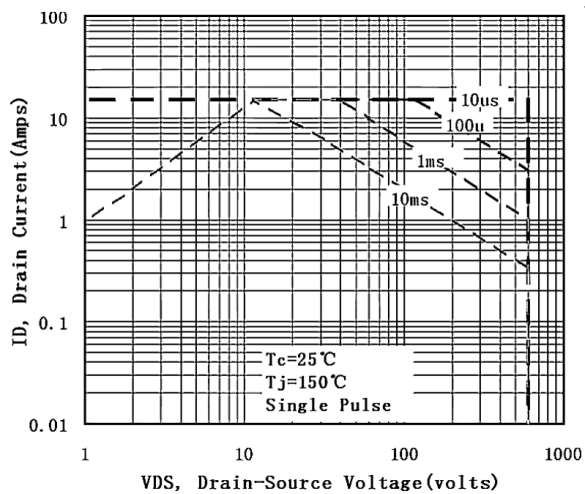

图 6-2 4N60(TO-220F)

最大安全工作区曲线

Fig6-2 Maximum Safe Operating Area

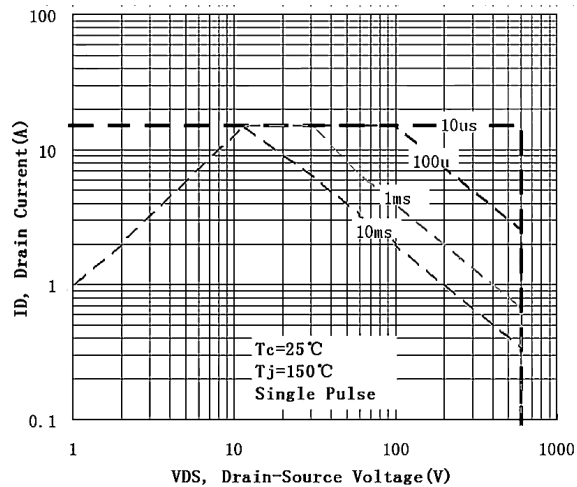

图6-3 4N60(TO-252)

最大安全工作区曲线

Fig6-3 Maximum Safe Operating Area

TO-220 封装

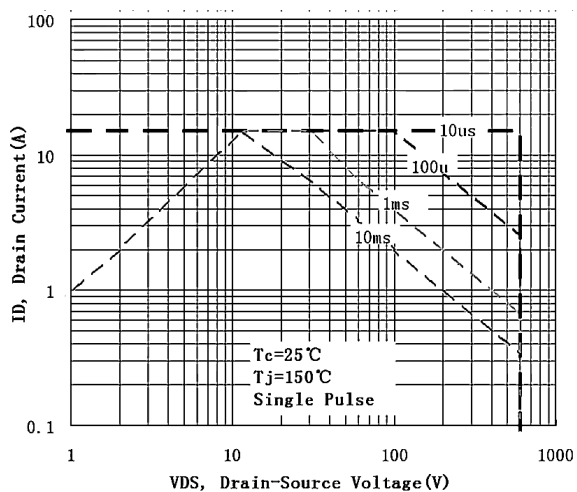
单位: 毫米/UNIT: mm

符号 SYMBOL	最小值 min	典型值 nom	最大值 max	符号 SYMBOL	最小值 min	典型值 nom	最大值 max
A	4.00		4.80	E	9.90		10.70
B	1.20		1.50	e		2.54	
B1	1.00		1.40	F	1.10		1.45
b1	0.65		1.00	L	12.50		14.50
c	0.35		0.75	L1	3.00	3.50	4.00
D	15.00		16.50	Q	2.50		3.00
D1	5.90		6.90	Q1	2.00		3.00
				φP	3.60		3.90

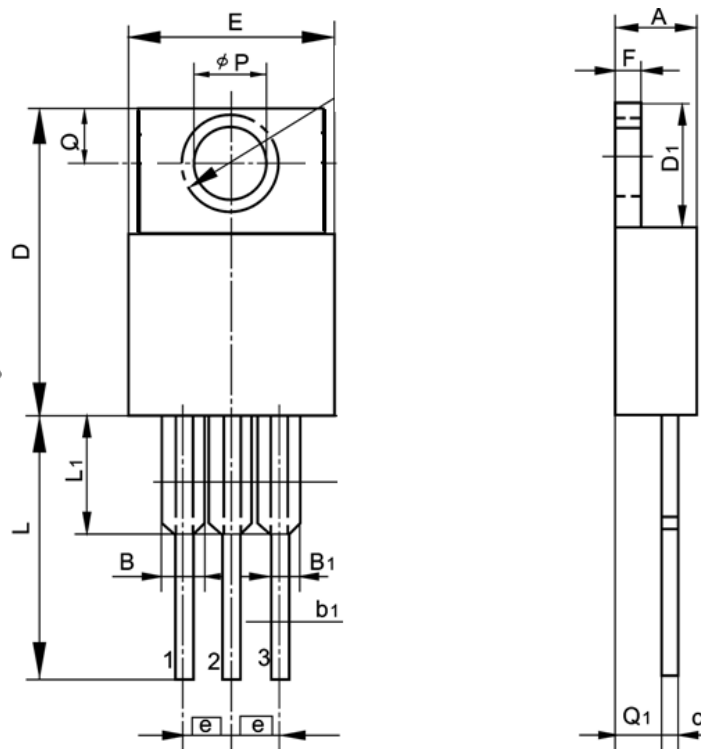

TO-220F 封装

单位:毫米/UNIT: mm

符号 SYMBOL	最小值 min	典型值 nom	最大值 max	符号 SYMBOL	最小值 min	典型值 nom	最大值 max
A	4.40		4.95	e		2.54	
A ₁	2.30		2.90	L	12.50		14.30
b	0.45		0.90	L ₁	9.10		10.05
b ₁	1.10		1.70	L ₂	15.00		16.00
c	0.35		0.90	L ₃	3.00		4.00
D	14.50		17.00	øp	3.00		3.50
D ₁	6.10		9.00	Q	2.30		2.80
E	9.60		10.30				

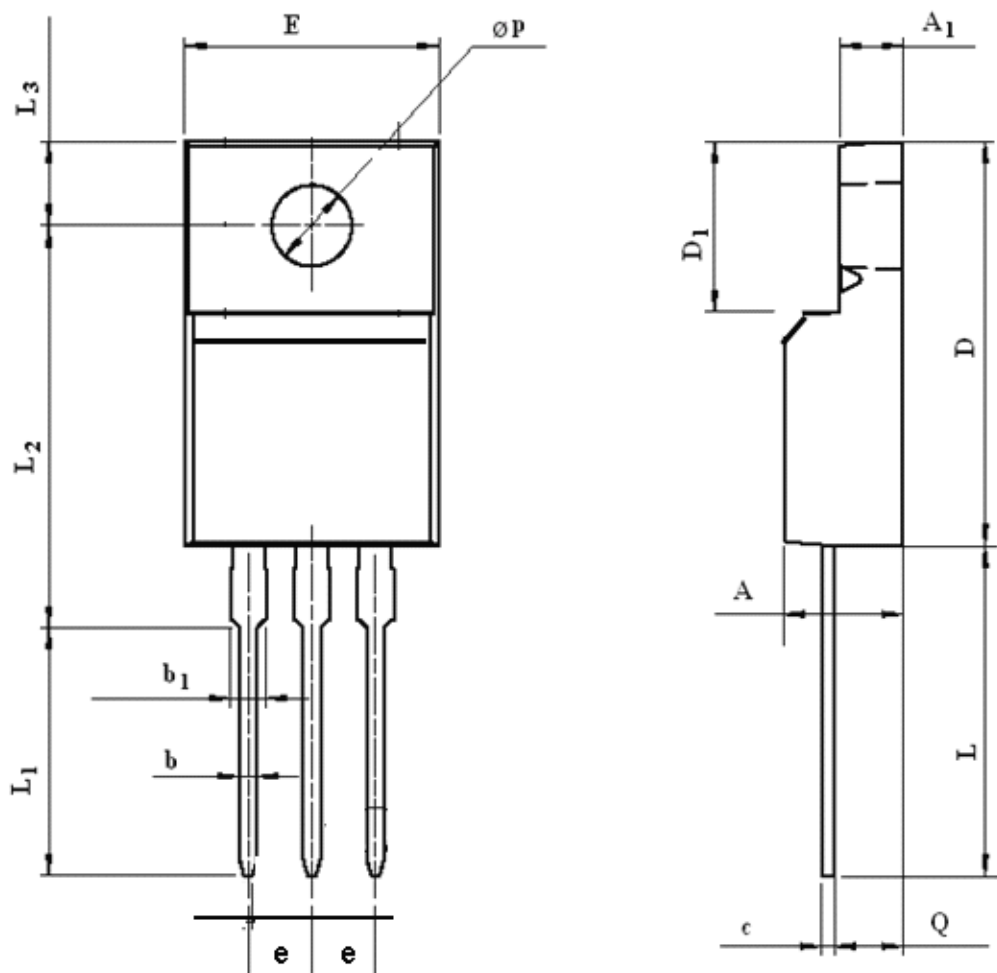

TO-252 封装机械尺寸
TO-252 MECHANICAL DATA

单位:毫米/UNIT: mm

符号 SYMBOL	最小值 min	最大值 max	符号 SYMBOL	最小值 min	最大值 max
A	2.10	2.50	B	0.85	1.25
b	0.50	0.80	b1	0.50	0.90
b2	0.45	0.70	C	0.45	0.70
D	6.30	6.75	D1	5.10	5.50
E	5.30	6.30	e1	2.25	2.35
L1	9.20	10.60	e2	4.45	4.75
L2	0.90	1.75	L3	0.60	1.10
K	0.00	0.23			

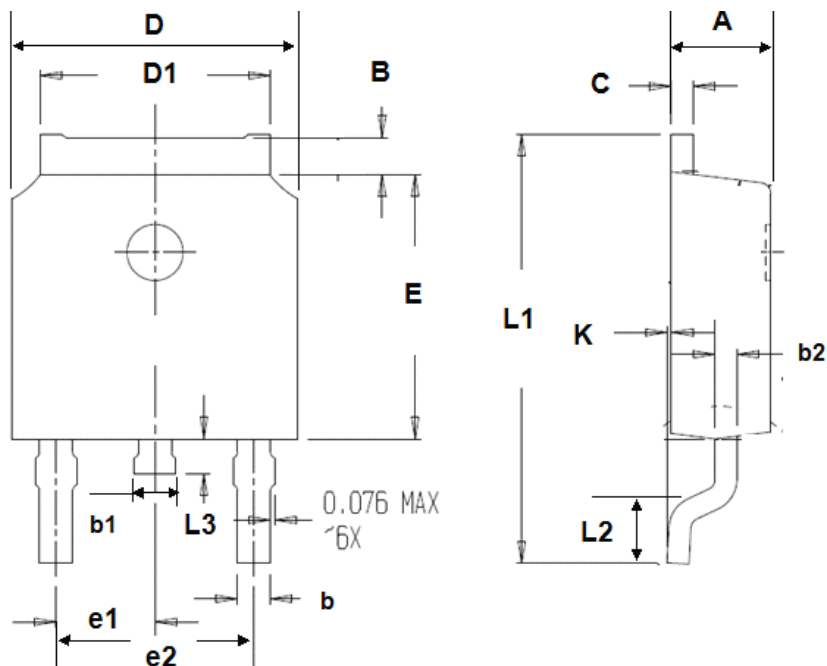

Ordering information

Order code	Package	Baseqty	Deliverymode
UMW 4N60L	TO-252	2500	Tape and reel
UMW 4N60	TO-220	1000	Tube and box
UMW 4N60L	TO-220F	1000	Tube and box