

FEATURES

- $V_{DS} (V) = -30V$
- $R_{DS(ON)} < 46m\Omega$ ($V_{GS} = -10V$)
- $R_{DS(ON)} < 54m\Omega$ ($V_{GS} = -4.5V$)

APPLICATIONS

- For Mobile Computing
- Load Switch
- Notebook Adaptor Switch
- DC/DC Converter

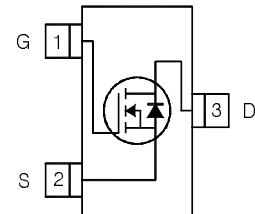
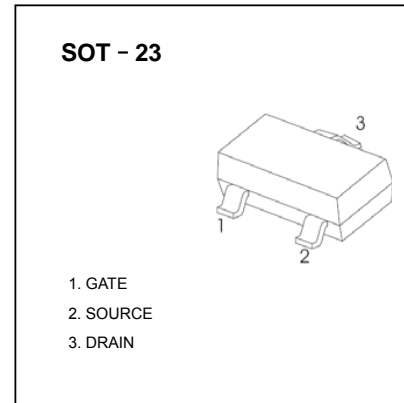

ABSOLUTE MAXIMUM RATINGS ($T_A = 25\text{ }^\circ\text{C}$, unless otherwise noted)

Parameter	Symbol	Limit	Unit
Drain-Source Voltage	V_{DS}	- 30	V
Gate-Source Voltage	V_{GS}	± 20	
Continuous Drain Current ($T_J = 150\text{ }^\circ\text{C}$)	I_D	$T_C = 25\text{ }^\circ\text{C}$	- 5.6
		$T_C = 70\text{ }^\circ\text{C}$	- 5.1
		$T_A = 25\text{ }^\circ\text{C}$	- 5.4 ^{b,c}
		$T_A = 70\text{ }^\circ\text{C}$	- 4.3 ^{b,c}
Pulsed Drain Current ($t = 100\text{ }\mu\text{s}$)	I_{DM}	- 18	A
Continuous Source-Drain Diode Current	I_S	$T_C = 25\text{ }^\circ\text{C}$	
		$T_A = 25\text{ }^\circ\text{C}$	- 1 ^{b,c}
Maximum Power Dissipation	P_D	$T_C = 25\text{ }^\circ\text{C}$	2.5
		$T_C = 70\text{ }^\circ\text{C}$	1.6
		$T_A = 25\text{ }^\circ\text{C}$	1.25 ^{b,c}
		$T_A = 70\text{ }^\circ\text{C}$	0.8 ^{b,c}
Operating Junction and Storage Temperature Range	T_J, T_{stg}	- 55 to 150	$^\circ\text{C}$

THERMAL RESISTANCE RATINGS

Parameter	Symbol	Typical	Maximum	Unit
Maximum Junction-to-Ambient ^{b,d}	R_{thJA}	75	100	$^\circ\text{C/W}$
Maximum Junction-to-Foot (Drain)	R_{thJF}	40	50	

Notes:

- a. Based on $T_C = 25\text{ }^\circ\text{C}$.
- b. Surface mounted on 1" x 1" FR4 board.
- c. $t = 5\text{ s}$.
- d. Maximum under steady state conditions is 166 $^\circ\text{C/W}$.

SPECIFICATIONS (T_J = 25 °C, unless otherwise noted)

Parameter	Symbol	Test Conditions	Min.	Typ.	Max.	Unit
Static						
Drain-Source Breakdown Voltage	V _{DS}	V _{GS} = 0 V, I _D = - 250 μA	- 30			V
V _{DS} Temperature Coefficient	ΔV _{DS} /T _J	I _D = - 250 μA		- 19		mV/°C
V _{GS(th)} Temperature Coefficient	ΔV _{GS(th)} /T _J		4			
Gate-Source Threshold Voltage	V _{GS(th)}	V _{DS} = V _{GS} , I _D = - 250 μA	- 0.5		- 2.0	V
Gate-Source Leakage	I _{GSS}	V _{DS} = 0 V, V _{GS} = ± 20 V			± 100	nA
Zero Gate Voltage Drain Current	I _{DSS}	V _{DS} = - 30 V, V _{GS} = 0 V			- 1	μA
		V _{DS} = - 30 V, V _{GS} = 0 V, T _J = 55 °C			- 5	
On-State Drain Current ^a	I _{D(on)}	V _{DS} ≤ - 5 V, V _{GS} = - 10 V	- 2.5			A
Drain-Source On-State Resistance ^a	R _{DS(on)}	V _{GS} = - 10 V, I _D = - 4.4 A		46	55	mΩ
		V _{GS} = - 4.5 V, I _D = - 3.6 A		54	63	
Forward Transconductance ^a	g _{fs}	V _{DS} = - 15 V, I _D = - 3.4 A		18		S
Dynamic^b						
Input Capacitance	C _{iss}	V _{DS} = - 15 V, V _{GS} = 0 V, f = 1 MHz		1295		pF
Output Capacitance	C _{oss}		150			
Reverse Transfer Capacitance	C _{riss}		130			
Total Gate Charge	Q _g	V _{DS} = - 15 V, V _{GS} = - 10 V, I _D = - 5.4 A		24	36	nC
		V _{DS} = - 15 V, V _{GS} = - 4.5 V, I _D = - 5.4 A		11.4	17	
Gate-Source Charge	Q _{gs}		3.4			
Gate-Drain Charge	Q _{gd}		3.8			
Gate Resistance	R _g	f = 1 MHz	1.5	7.7	15.4	Ω
Turn-On Delay Time	t _{d(on)}	V _{DD} = - 15 V, R _L = 3.5 Ω I _D ≅ - 4.3 A, V _{GEN} = - 10 V, R _g = 1 Ω		13	20	ns
Rise Time	t _r		4	8		
Turn-Off Delay Time	t _{d(off)}		38	57		
Fall Time	t _f		6	12		
Turn-On Delay Time	t _{d(on)}	V _{DD} = - 15 V, R _L = 3.5 Ω I _D ≅ - 4.3 A, V _{GEN} = - 4.5 V, R _g = 1 Ω		28	42	
Rise Time	t _r		16	24		
Turn-Off Delay Time	t _{d(off)}		30	45		
Fall Time	t _f		10	20		
Drain-Source Body Diode Characteristics						
Continuous Source-Drain Diode Current	I _S	T _C = 25 °C			- 2.1	A
Pulse Diode Forward Current (t = 100 μs)	I _{SM}				- 80	
Body Diode Voltage	V _{SD}	I _S = - 4.3 A, V _{GS} = 0 V		- 0.8	- 1.2	V
Body Diode Reverse Recovery Time	t _{rr}	I _F = - 4.3 A, di/dt = 100 A/μs, T _J = 25 °C		15	23	ns
Body Diode Reverse Recovery Charge	Q _{rr}		7	14	nC	
Reverse Recovery Fall Time	t _a		8		ns	
Reverse Recovery Rise Time	t _b		7			

Notes:

- Pulse test; pulse width ≤ 300 μs, duty cycle ≤ 2 %.
- Guaranteed by design, not subject to production testing.

TYPICAL CHARACTERISTICS (25 °C, unless otherwise noted)

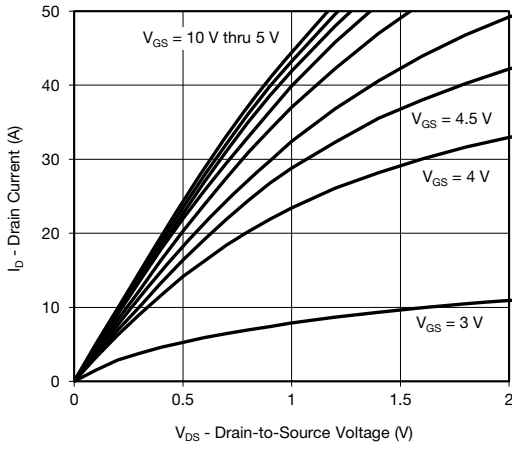

Output Characteristics

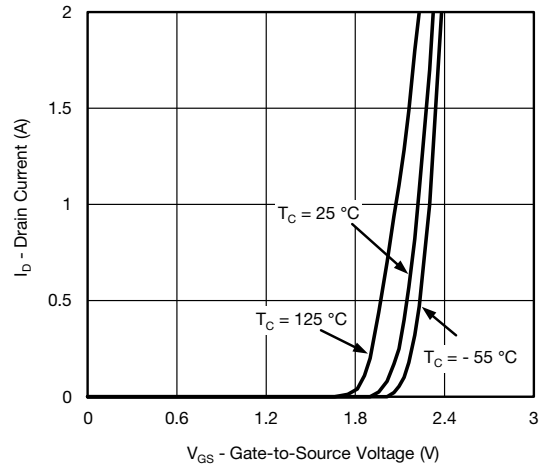

Transfer Characteristics

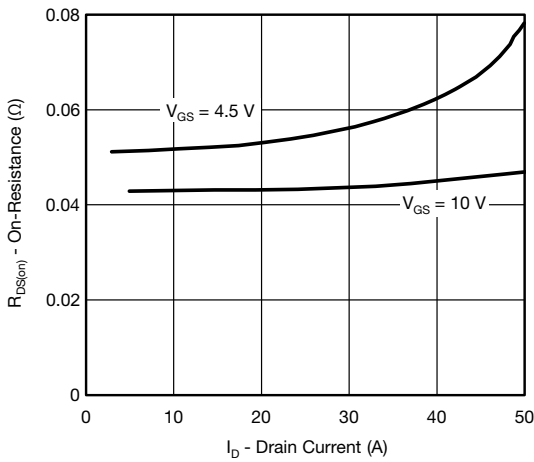

On-Resistance vs. Drain Current

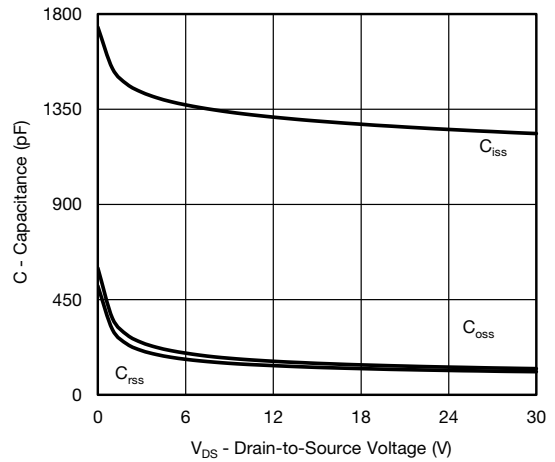

Capacitance

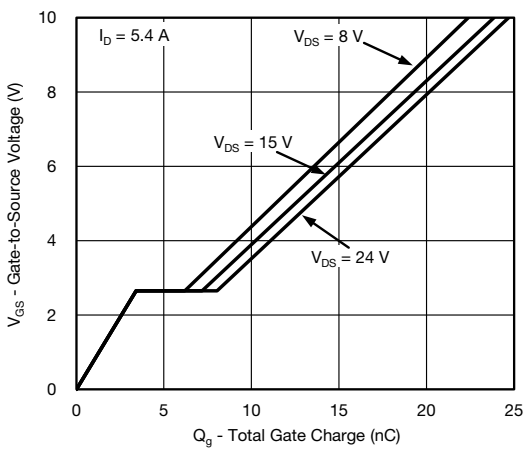

Gate Charge

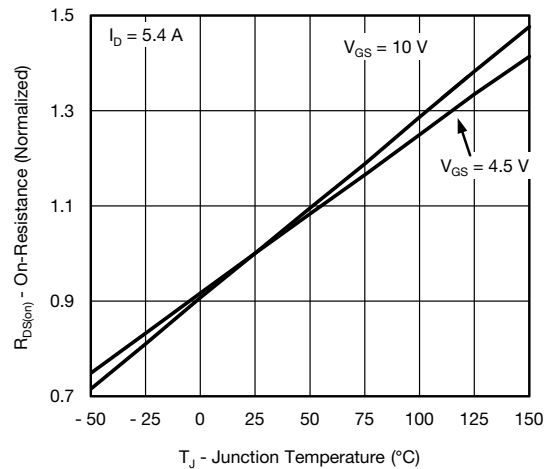

On-Resistance vs. Junction Temperature

TYPICAL CHARACTERISTICS (25 °C, unless otherwise noted)

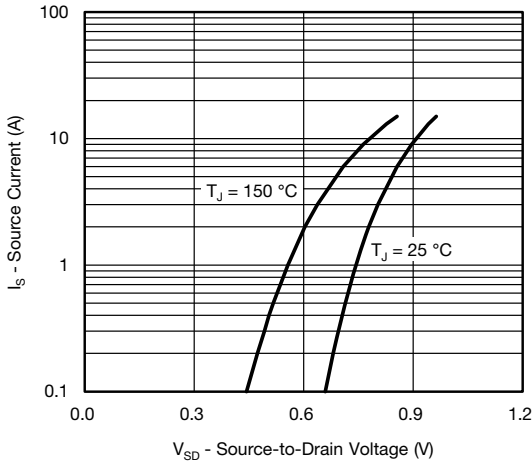

Source-Drain Diode Forward Voltage

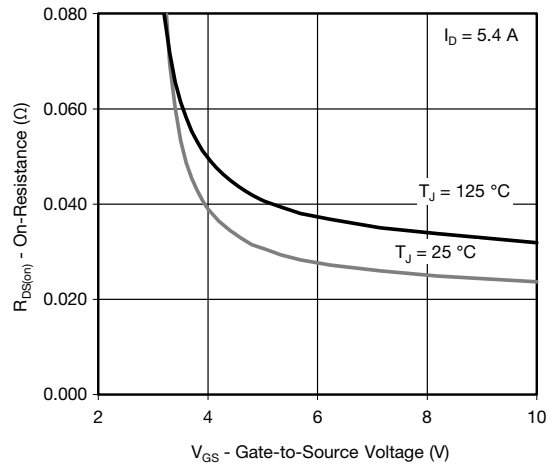

On-Resistance vs. Gate-to-Source Voltage

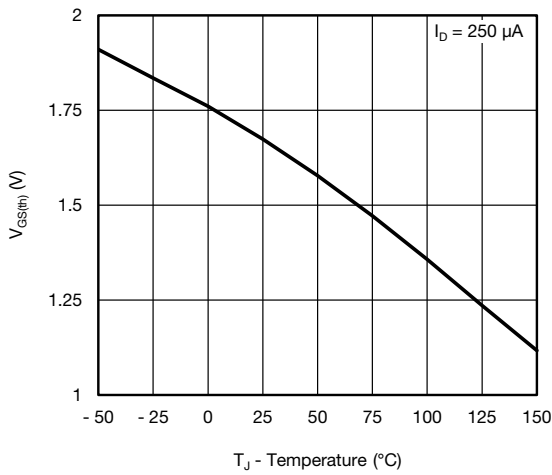

Threshold Voltage

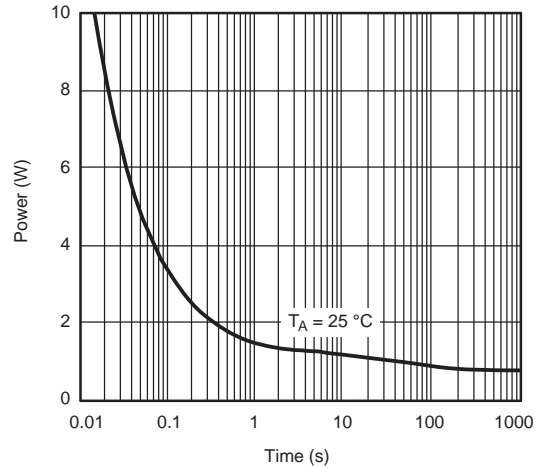

Single Pulse Power (Junction-to-Ambient)

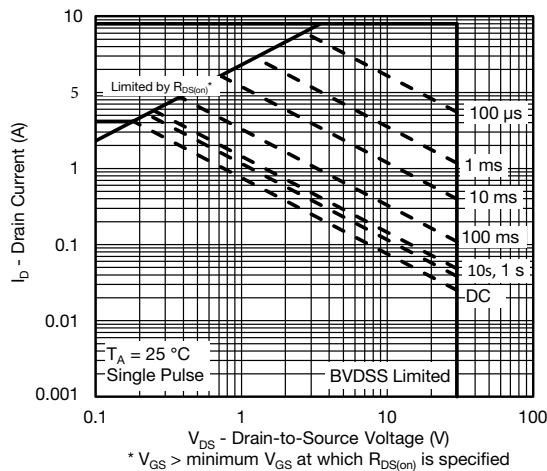

Safe Operating Area, Junction-to-Ambient

TYPICAL CHARACTERISTICS (25 °C, unless otherwise noted)

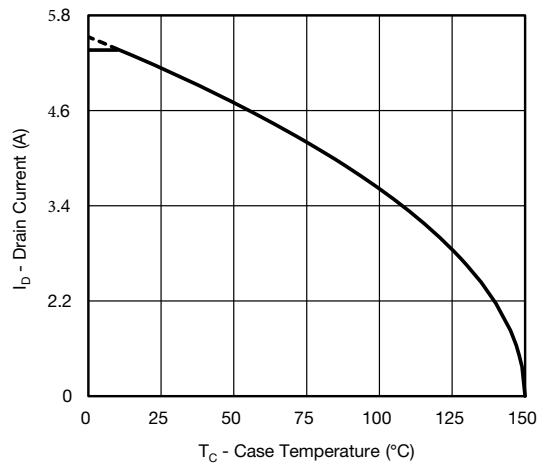

Current Derating*

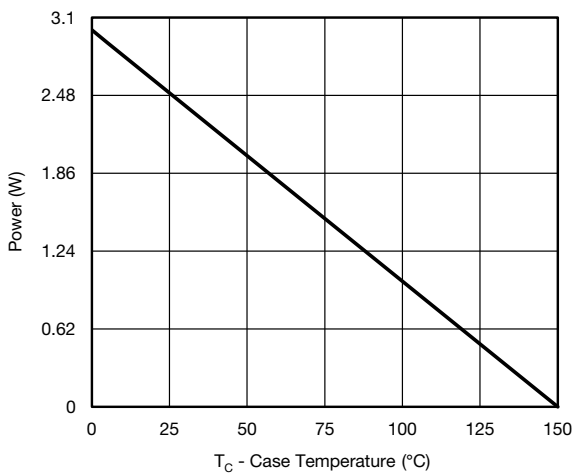

Power, Junction-to-Foot

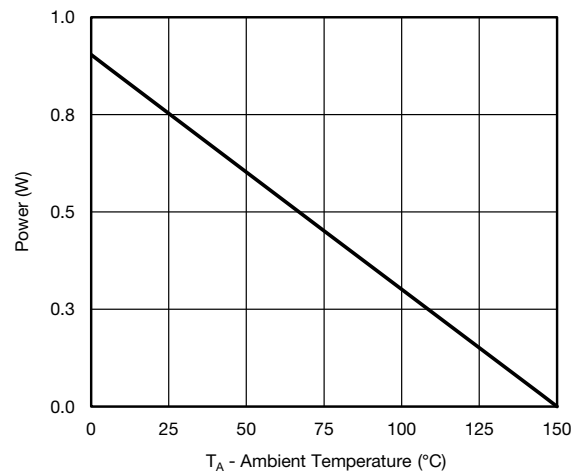

Power, Junction-to-Ambient

* The power dissipation P_D is based on T_{J(max.)} = 150 °C, using junction-to-case thermal resistance, and is more useful in settling the upper dissipation limit for cases where additional heatsinking is used. It is used to determine the current rating, when this rating falls below the package limit.

TYPICAL CHARACTERISTICS (25 °C, unless otherwise noted)

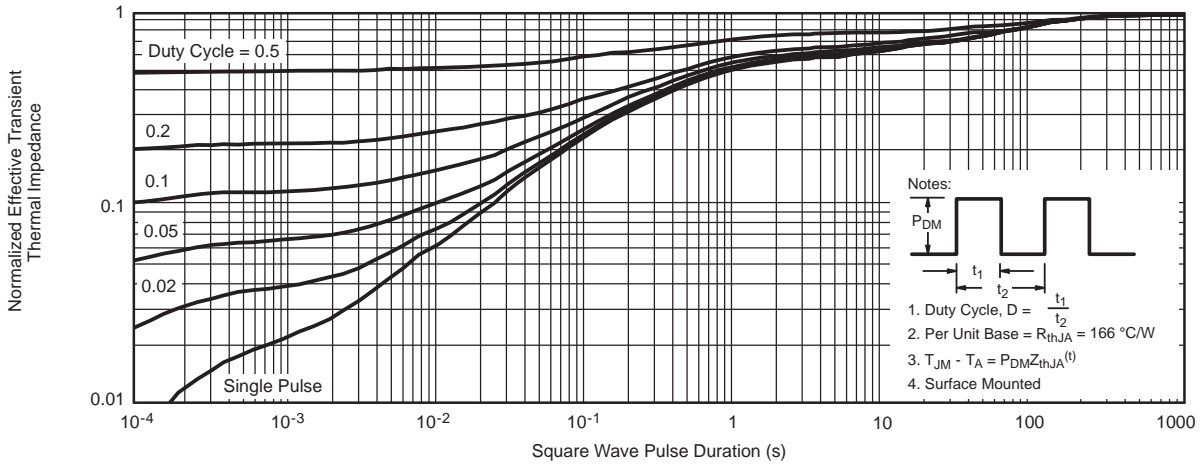

Normalized Thermal Transient Impedance, Junction-to-Ambient

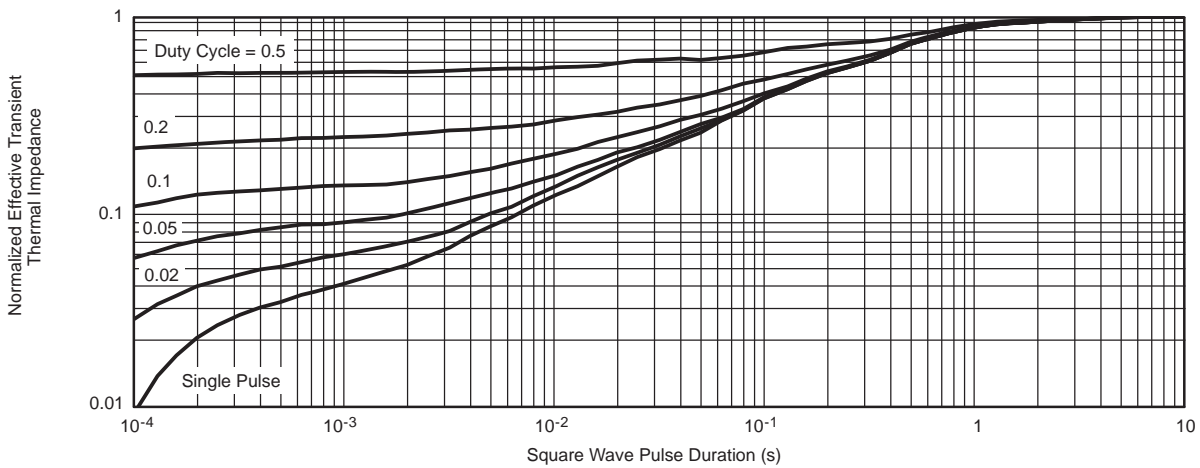

Normalized Thermal Transient Impedance, Junction-to-Foot

SOT-23 PACKAGE OUTLINE DIMENSIONS

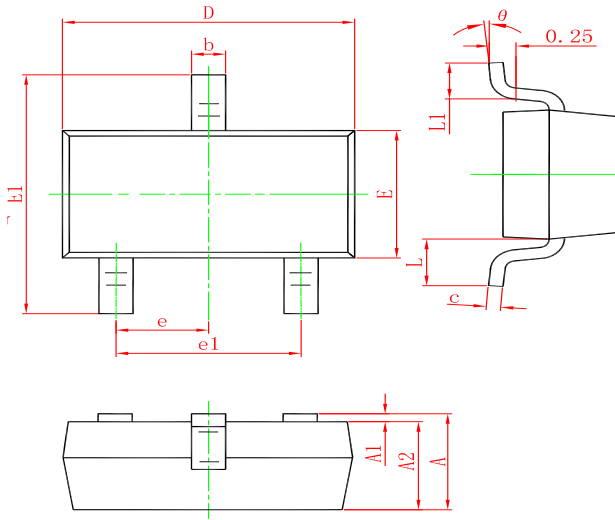

Symbol	Dimensions In Millimeters		Dimensions In Inches	
	Min.	Max.	Min.	Max.
A	0.900	1.150	0.035	0.045
A1	0.000	0.100	0.000	0.004
A2	0.900	1.050	0.035	0.041
b	0.300	0.500	0.012	0.020
c	0.080	0.150	0.003	0.006
D	2.800	3.000	0.110	0.118
E	1.200	1.400	0.047	0.055
E1	2.250	2.550	0.089	0.100
e	0.950 TYP.		0.037 TYP.	
e1	1.800	2.000	0.071	0.079
L	0.550 REF.		0.022 REF.	
L1	0.300	0.500	0.012	0.020
θ	0°	8°	0°	8°

Marking

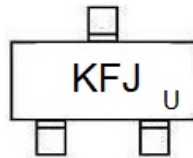

Ordering information

Order code	Package	Baseqty	Deliverymode
UMW SSM3J332R	SOT-23	3000	Tape and reel