

ROHS

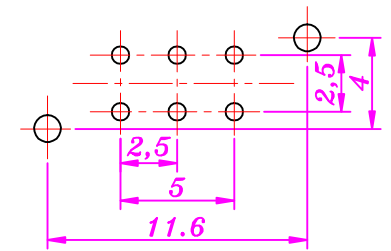

HAOYU

SCHEMATIC

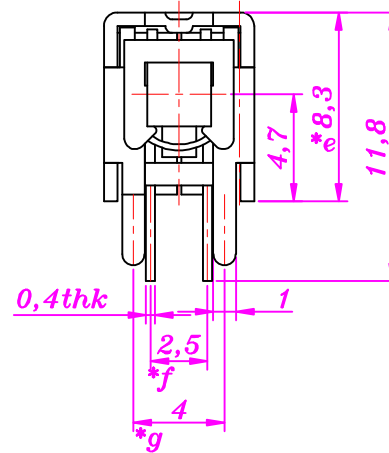
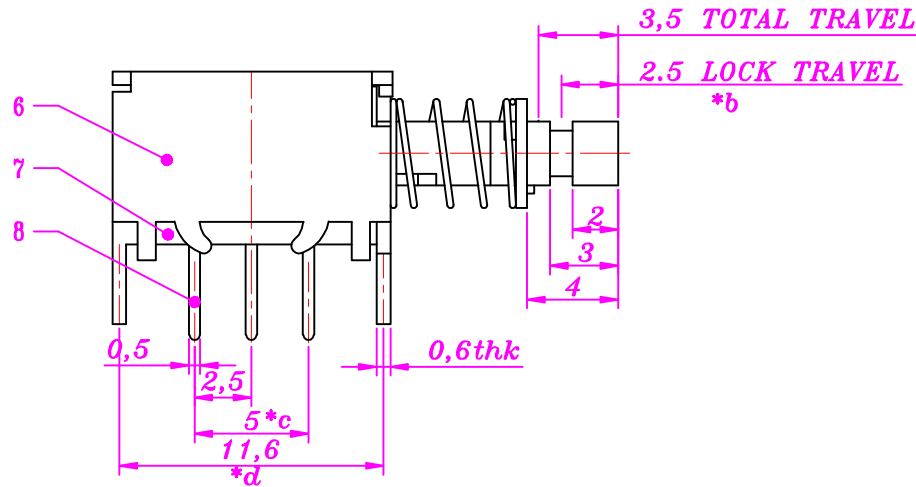
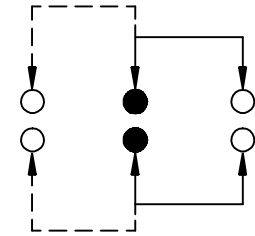
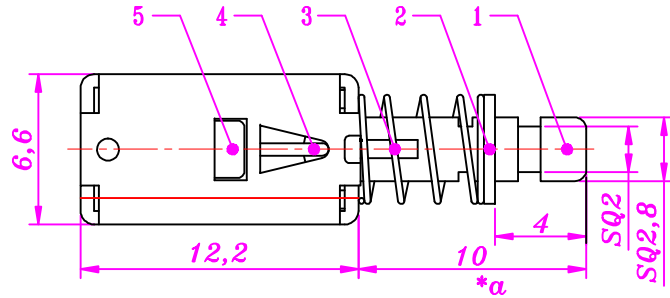

PCB LAYOUT

9	CONTACT CLIP	PHOSPHOR BRONZE	2	Ag CLAD
8	TERMINAL	BRASS	6	Ag-PLATED
7	BASE	PHENOLIC RESIN	1	NATURAL
6	FRAME	STEEL	1	Ni-PLATED
5	SPRING PLATE	PHOSPHOR BRONZE	1	NATURAL
4	CAM STICK	PHOSPHOR BRONZE	1	NATURAL
3	SPRING	SUS	1	Ni-PLATED
2	BLOCK	STEEL	1	Ni-PLATED
1	KNOB	PA66	1	
NO.	PART NAME	MATERIAL	QTY	FINISHING

TOLERANCE								
UNLESS SPECIFIED								
UP TO 5mm: ±0.1	ANGULAR	1	2016.4.25	更新图纸				
ABOVE 5mm: ±0.2	±1°	NO	DATE	REVISIONS		BY	APPD	
TITLE: PUSH SWITCH			UNIT : MM	ROHS	DWN			
MODEL: PS-22E05-S PA66柄			SCALE: 1:1	COMPLIANT	CHK'D			
 HAOYU(HONGKONG)LIMITED 皓宇(香港)有限公司				APPD				
				PRO.AGL:			REV :A1	