



SURFACE MOUNT ULTRAFAST RECOVERY RECTIFIER

Reverse Voltage - 50 to 1000 V

Forward Current - 2 A

FEATURES

- For surface mounted applications
- Low profile package
- Glass Passivated Chip Junction
- Easy to pick and place
- High efficiency
- Lead free in comply with EU RoHS 2011/65/EU directives

MECHANICAL DATA

- Case: SMB
- Terminals: Solderable per MIL-STD-750, Method 2026
- Approx. Weight: 0.095g / 0.003oz

PINNING

PIN	DESCRIPTION
1	Cathode
2	Anode

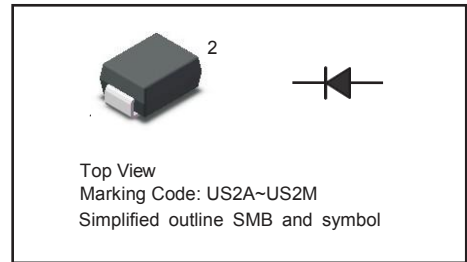

Maximum Ratings and Electrical characteristics

Ratings at 25 ° C ambient temperature unless otherwise specified.

Single phase half-wave 60 Hz, resistive or inductive load, for capacitive load current derate by 20 %.

Parameter	Symbols	US2A	US2B	US2D	US2G	US2J	US2K	US2M	Units
Maximum Repetitive Peak Reverse Voltage	V_{RRM}	50	100	200	400	600	800	1000	V
Maximum RMS voltage	V_{RMS}	35	70	140	280	420	560	700	V
Maximum DC Blocking Voltage	V_{DC}	50	100	200	400	600	800	1000	V
Maximum Average Forward Rectified Current at $T_c = 125^\circ C$	$I_{F(AV)}$	2							A
Peak Forward Surge Current 8.3 ms Single Half Sine Wave Superimposed on Rated Load	I_{FSM}	50							A
Maximum Instantaneous Forward Voltage at 2 A	V_F	1.0		1.3		1.65			V
Maximum DC Reverse Current $T_a = 25^\circ C$ at Rated DC Blocking Voltage $T_a = 125^\circ C$	I_R	5 100							μA
Maximum Reverse Recovery Time ⁽¹⁾	t_{rr}	50				75			ns
Typical Thermal Resistance ⁽²⁾	$R_{\theta JA}$	60							$^\circ C/W$
Typical Junction Capacitance at $V_R=4V, f=1MHz$	C_j	20							pF
Operating and Storage Temperature Range	T_j, T_{stg}	-55 ~ +150							$^\circ C$

(1) Measured with $I_f = 0.5 A, I_R = 1 A, I_{rr} = 0.25 A$.

(2) P.C.B. mounted with 2.0" X 2.0" (5 X 5 cm) copper pad areas.



Fig.1 Forward Current Derating Curve

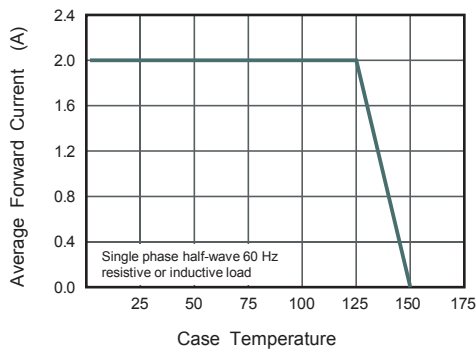

Fig.2 Typical Reverse Characteristics

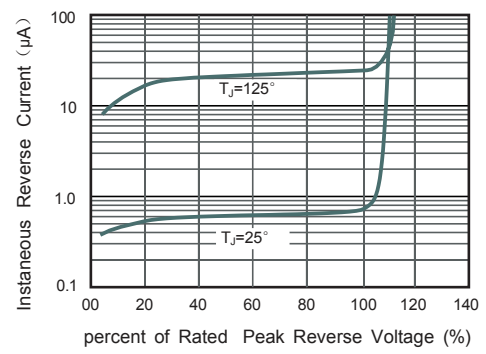

Fig.3 Typical Forward Characteristics

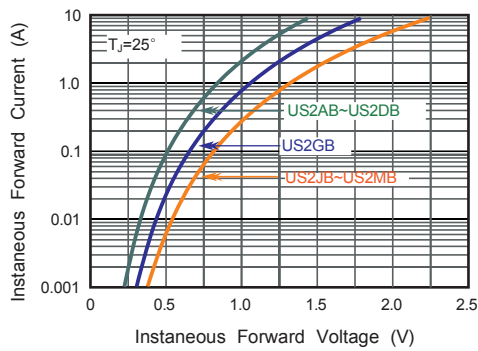
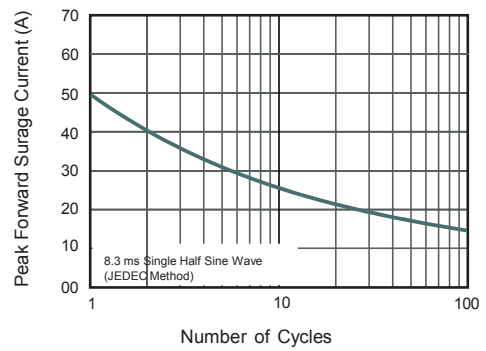

Fig.4 Maximum Non-Repetitive Peak Forward Surge Current





PACKAGE OUTLINE

Plastic surface mounted package; 2 leads

SMB

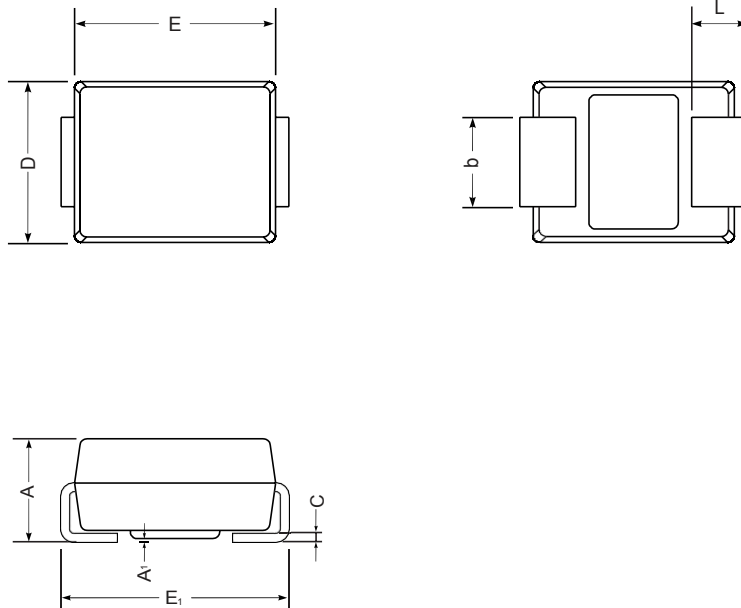

SMB mechanical data

UNIT		A	E	D	E ₁	A ₁	L	C	b
mm	max	2.5	4.70	3.94	5.5	0.20	1.5	0.305	2.2
	min	2.1	4.06	3.3	5.0	0.05	0.8	0.152	1.9
mil	max	98	185	155	216	7.9	59	12	87
	min	82	160	130	196	2.0	32	6	75

The recommended mounting pad size

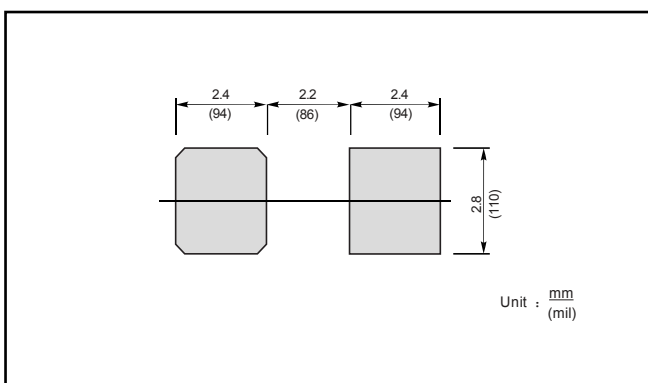

Marking

Type number	Marking code
US2A	US2A
US2B	US2B
US2D	US2D
US2G	US2G
US2J	US2J
US2K	US2K
US2M	US2M