

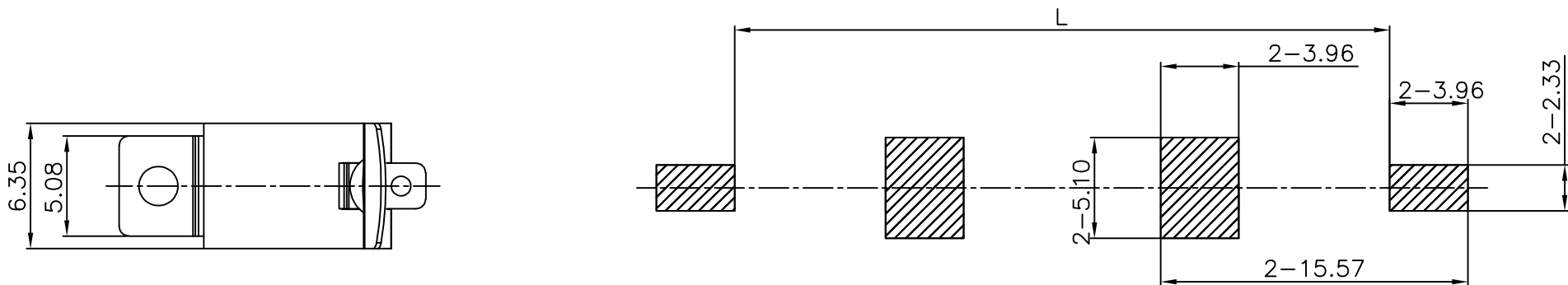

REV.	ECN NO.	REVISED	DATE

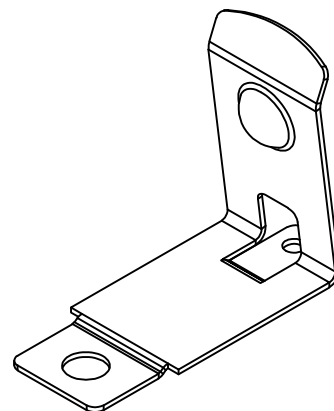

PCB Layout Diagram
Top View

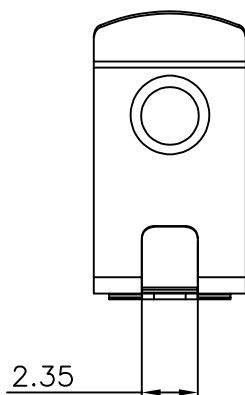
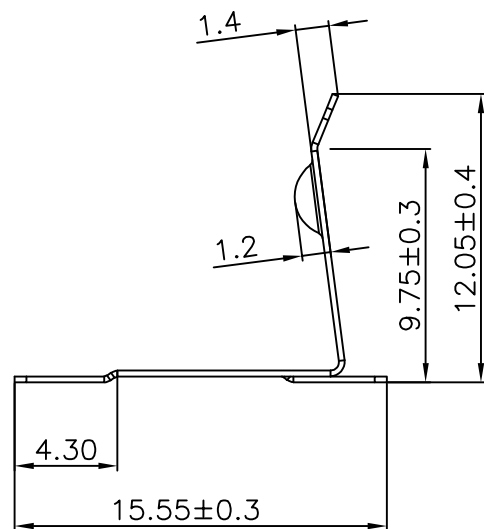

工程部
2023-11-14
H. WANG

CELL SIZE	'L' DIMENSION
AA	48.30
CR2	24.60
CR123A	31.20

UNLESS OTHERWISE SPECIFIED TOLERANCES		MYOUNG 美用 www.meiyangdz.com	
DECIMALS: X :±0.30 X.X :±0.25 X.XX :±0.20 X.XXX :±0.10	ANGLES: X :±1° X.X :±0.5°	DSND WangHeng	DATE 2023-11-14
WEIGHT: g		CHKD ZhouRuicai	DATE 2023-11-14
SHEET 1 OF 2		APVD XueShunyong	DATE 2023-11-14
SCALE: 4:1		SIZE: A4	VIEW:
UNIT: mm		REV.: A/0	OBJECT: MY
TITLE: 电池弹片TER-161 SMT 卷装		PART NO.: MY-AA-03-R	
DRAW NO.:MY-CP-0265			

1	TERMINAL	1	Mn STEEL, T=0.25mm	Ni-Plating
NO.	PART NAME	Q'TY	MATERIAL	PLATING & COLOR

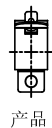

产品

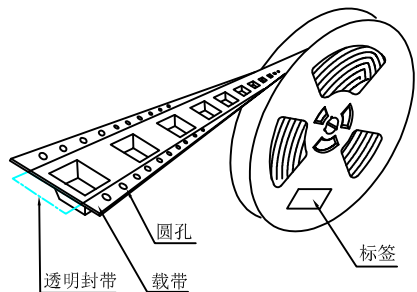

圆孔

载带

标签

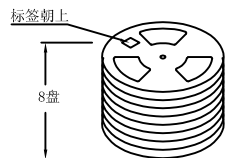

标签朝上

8盘

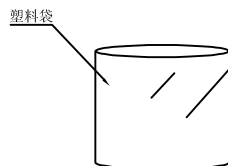

塑料袋

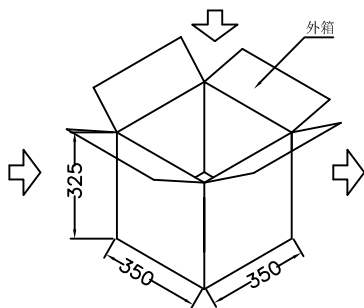

外箱

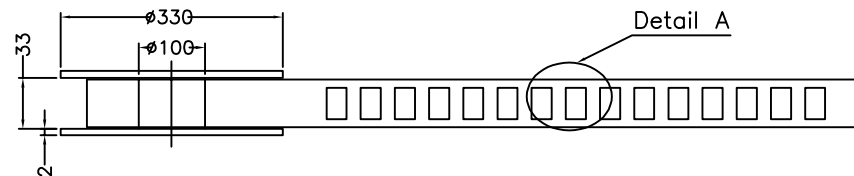
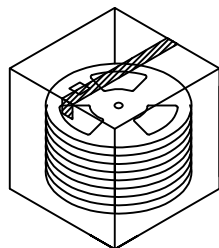

Detail A

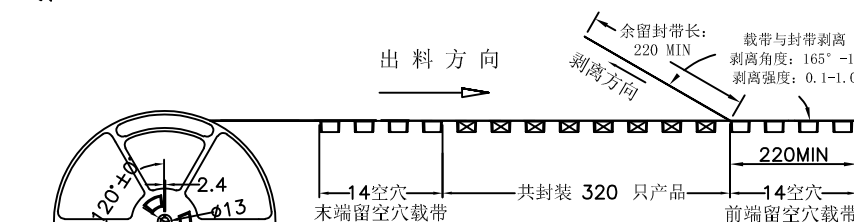

出料方向

剥离方向

余留封带长: 220 MIN
载带与封带剥离角度: 165°-180°
剥离强度: 0.1-1.0N

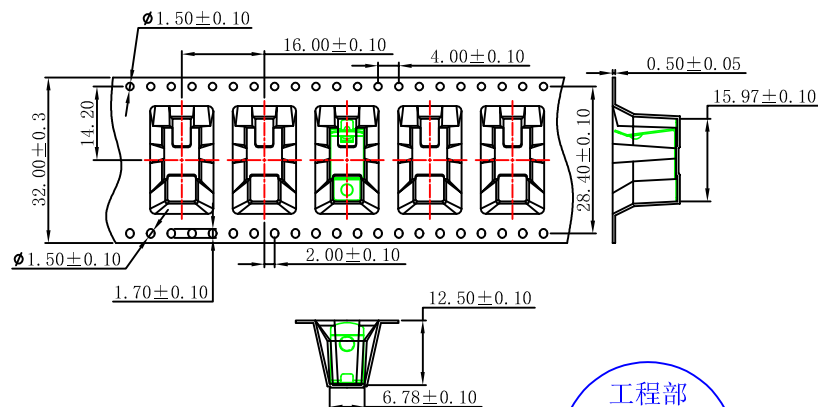
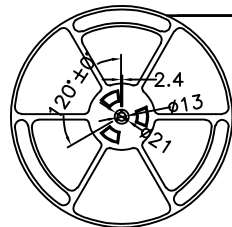

技术要求:

- 圆孔十个孔距累计允许公差为±0.2mm
- 带长250mm内容许弯曲度1mm
- 材料厚度以在载带边缘测量为准
- 所有尺寸定义依循EIA-481-C标准则定义之
- 材料: 黑色PS T=0.50mm
- 所有卷轮为灰蓝挖空旋转塑胶卷轮
- 整模成型长度: 5.568M,
- 非指明公差范围为: ±0.1mm; 超过250mm 不计算累计误差
- 型腔外形凡未标明处倒角R为0.2-0.3; 拔模斜度未标注的为3° 以下

包装信息:

- 每卷盘装产品 320 只, 卷盘外侧贴相关标签;
- 每 8 卷盘放在一个塑料袋中;
- 每外箱装8盘, 产品总数: 2560 只;
- 外箱上下用胶纸封成"工"字;
- 电池弹片包材TER161 SMT 卷装(MY-AA-03-R)。

UNLESS OTHERWISE SPECIFIED TOLERANCES		MYOUNG 美阳 www.meiyangdz.com	
DECIMALS: X : ±***	ANGLES: X : ±***	DSND WangHeng	DATE 2023-11-14
X.X : ±***	X.X : ±***	CHKD ZhouRuicai	DATE 2023-11-14
X.XX : ±***	X.X : ±***	APVD XueShunYong	DATE 2023-11-14
X.XXX : ±***	X.X : ±***	WEIGHT:	SCALE: 1:1
		SHEET 2 OF 2	UNIT: mm
			SIZE: A4
			VIEW:
			REV.: A/0
			OBJECT: MY
TITLE: 电池弹片TER-161 SMT 卷装		PART NO.: MY-AA-03-R	
DRAW NO.: MY-BD-0034			