

MCMB-0630 Series

High Current Molded Power Inductors

FEATURES

- Powder iron core material
- Magnetically shielded, low EMI
- High current carrying capacity, Low core losses
- Frequency range up to 5MHz
- Operate temperature range $-40^{\circ}\text{C} \sim +125^{\circ}\text{C}$ (Including self temp. rise)
- RoHS compliant

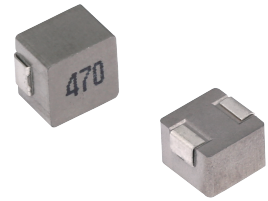

APPLICATIONS

- Voltage Regulator Module (VRM)
- Multi-phase regulators
- Point-of-load modules
- Smart phone POL modules
- SSD modules
- Notebook regulators
- Battery power systems
- Graphics cards
- Data networking and storage systems

Explanation of Part Number

MCMB -0630 -1R0 M T

1 2 3 4 5

- ◆ 1:Product Series:Metal Alloy Molding Power Inductor
- ◆ 2:Dimensions:
- ◆ 3: Initial inductance value: 1R0 = 1.0uH
- ◆ 4:Tolerance of Inductance:M: $\pm 20\%$
- ◆ 5.Packing:Tape Carrier Package

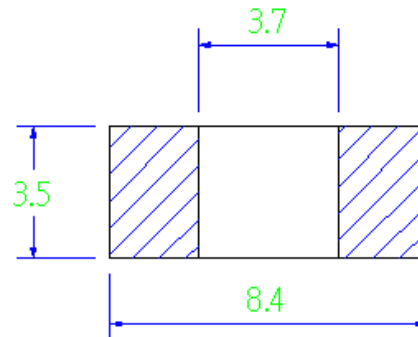
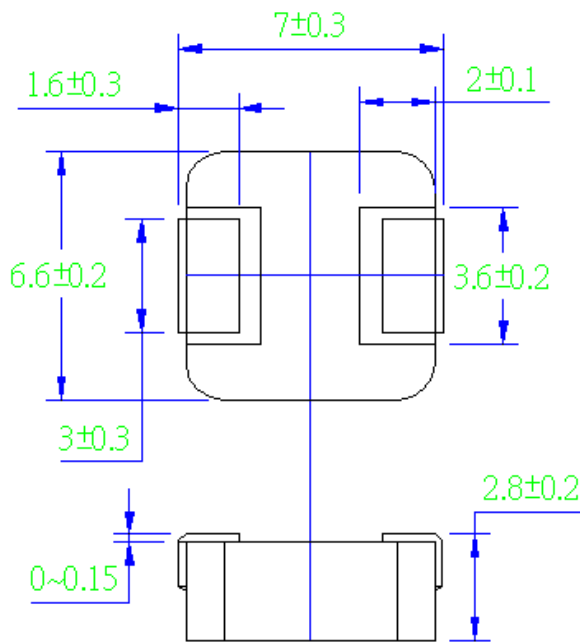
Dimensions: [mm]

Recommend Land Pattern Dimensions
Electrical Properties:

Part No.	Inductance	DC Resistance		Heating Rating Current	Saturation Current
	L0 (μH)	DCR ($\text{m}\Omega$)		I _{dc} (A)	I _{sat} (A)
	$\pm 20\%$, 100 kHz, 1V	TYP.	MAX.	TYP.	TYP.
MCMB-0630-R10MT	0.1	0.9	1.2	32.0	56.0
MCMB-0630-R22MT	0.22	2.5	3.0	24.0	34.0
MCMB-0630-R24MT	0.24	2.6	3.1	23.0	26.0
MCMB-0630-R33MT	0.33	3.0	3.5	21.0	25.0
MCMB-0630-R47MT	0.47	3.5	4.1	18.0	20.0
MCMB-0630-R56MT	0.56	3.9	4.5	16.5	18.0
MCMB-0630-R68MT	0.68	4.8	5.3	16.0	17.0
MCMB-0630-R82MT	0.82	5.4	6.0	14.0	16.0
MCMB-0630-1R0MT	1.0	6.7	7.4	12.0	15.0
MCMB-0630-1R5MT	1.5	10.6	12.1	12.0	14.0
MCMB-0630-2R2MT	2.2	13.5	15.0	9.5	10.0
MCMB-0630-3R3MT	3.3	18.0	22.0	8.5	9.5
MCMB-0630-4R7MT	4.7	28.0	33.0	6.0	6.5
MCMB-0630-5R6MT	5.6	37.0	42.0	5.0	6.0
MCMB-0630-6R8MT	6.8	42.5	48.0	5.0	6.0
MCMB-0630-8R2MT	8.2	54.0	60.0	5.0	6.0
MCMB-0630-100MT	10.0	62.0	67.0	4.5	5.5

Part No.	Inductance	DC Resistance		Heating Rating Current	Saturation Current
	L0 (μH)	DCR (mΩ)		Idc (A)	Isat (A)
	±20 %, 100 kHz, 1V	TYP.	MAX.	TYP.	TYP.
MCMB-0630-150MT	15.0	104.0	115.0	3.0	4.5
MCMB-0630-220MT	22.0	180.0	200.0	2.3	3.0
MCMB-0630-330MT	33.0	280.0	310.0	2.0	2.5
MCMB-0630-470MT	47.0	310.0	385.0	1.5	2.0

Notes

1. All test data is referenced to 25 °C ambient
2. Idc(A):DC current (A) that will cause an approximate ΔT of 40 °C(reference ambient temperature is 25°C)
3. Isat(A):DC current (A) that will cause L0 to drop approximately 30 %
4. The part temperature (ambient + temp rise) should not exceed 125 °C under worst case operating conditions. Circuit design, component placement, PWB trace size and thickness, airflow and other cooling provisions all affect the part temperature. Part temperature should be verified in the end application.

Performance Graphs
Test Instruments

 Wayne kerr 3260B/G LCR Meter
 Wayne kerr 3265B Bias Current Source

Test Condition

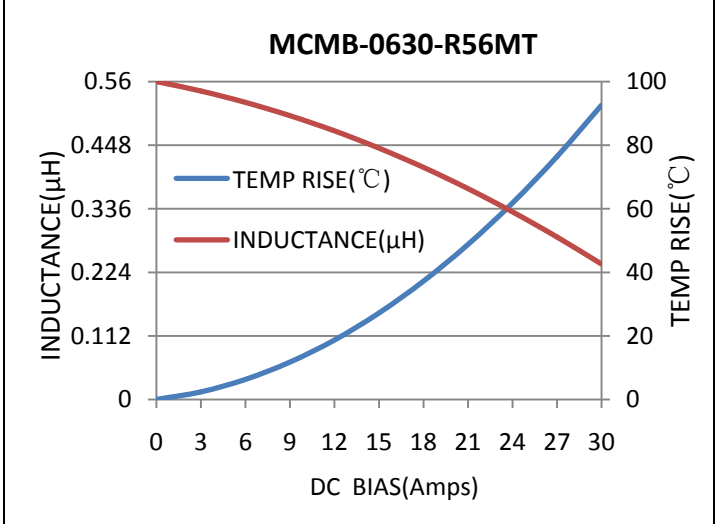
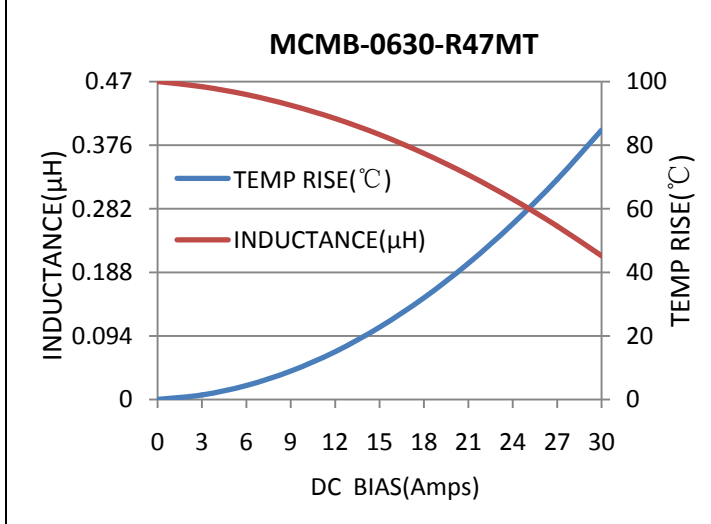
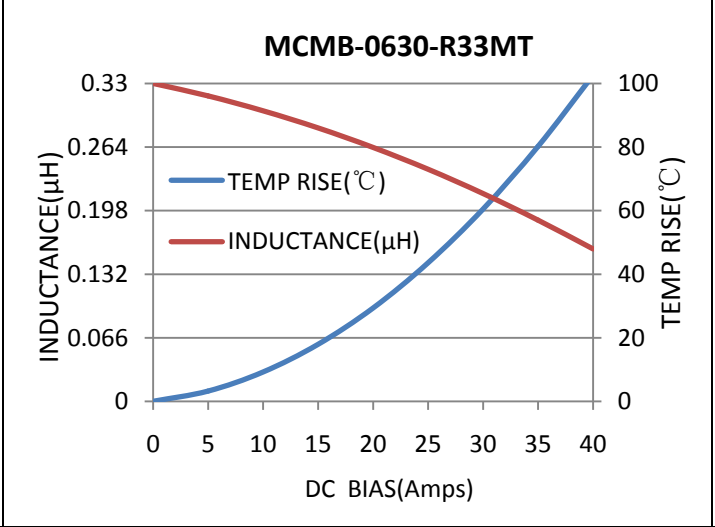
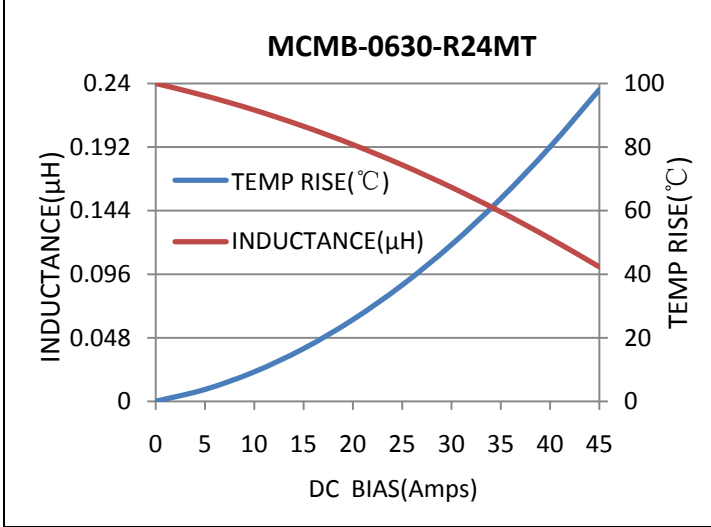
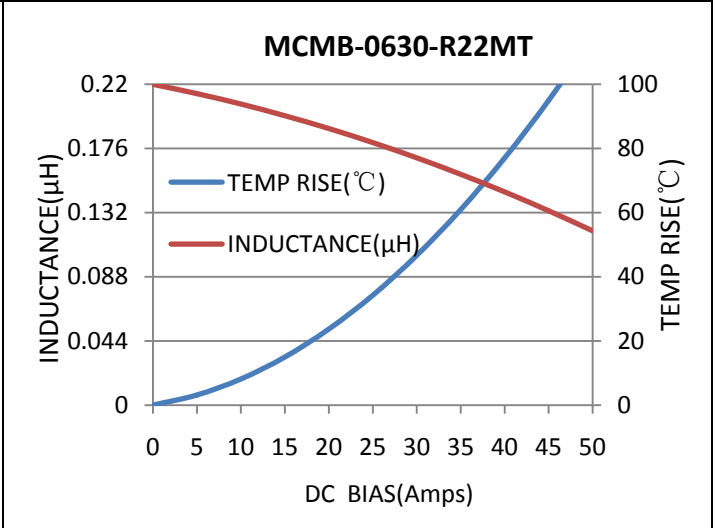
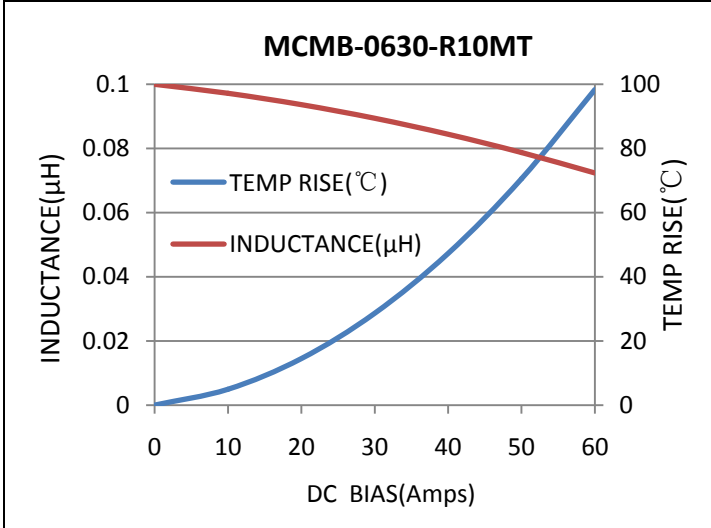
 Temperature: $26 \pm 3^\circ\text{C}$
 Humidity: $< 70\% \text{ RH}$
 Frequency: 100 KHz, 1.0V

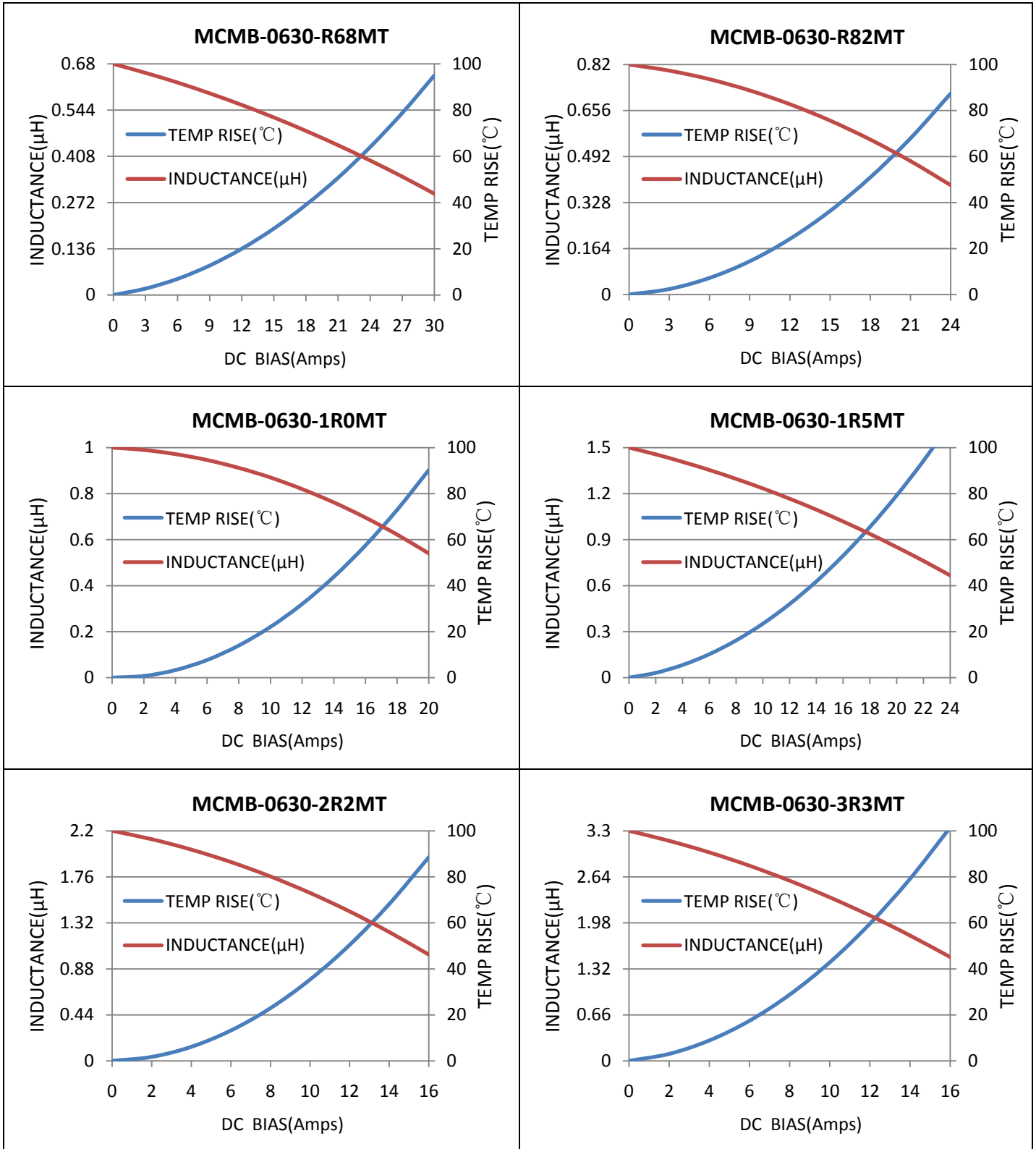

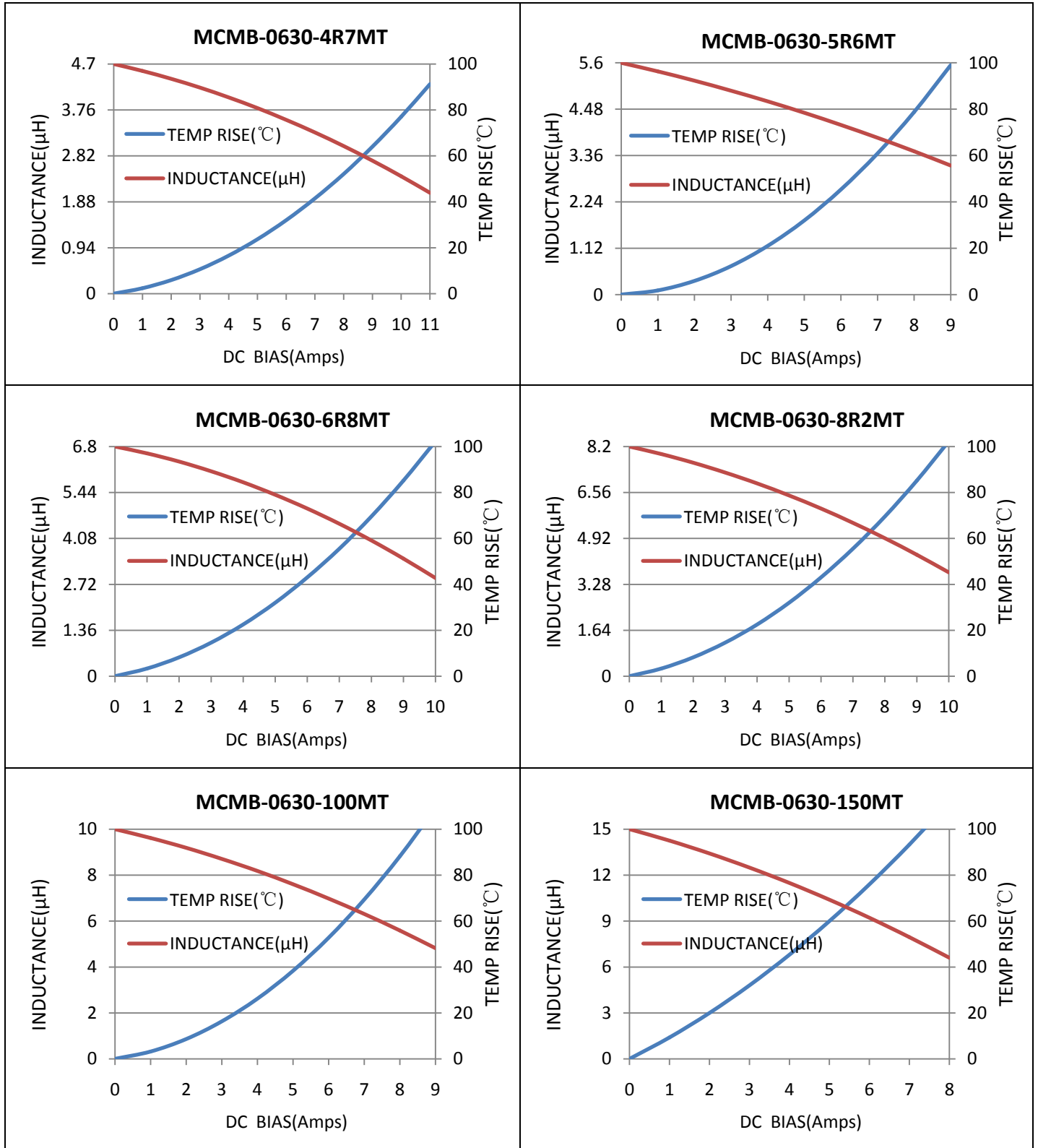

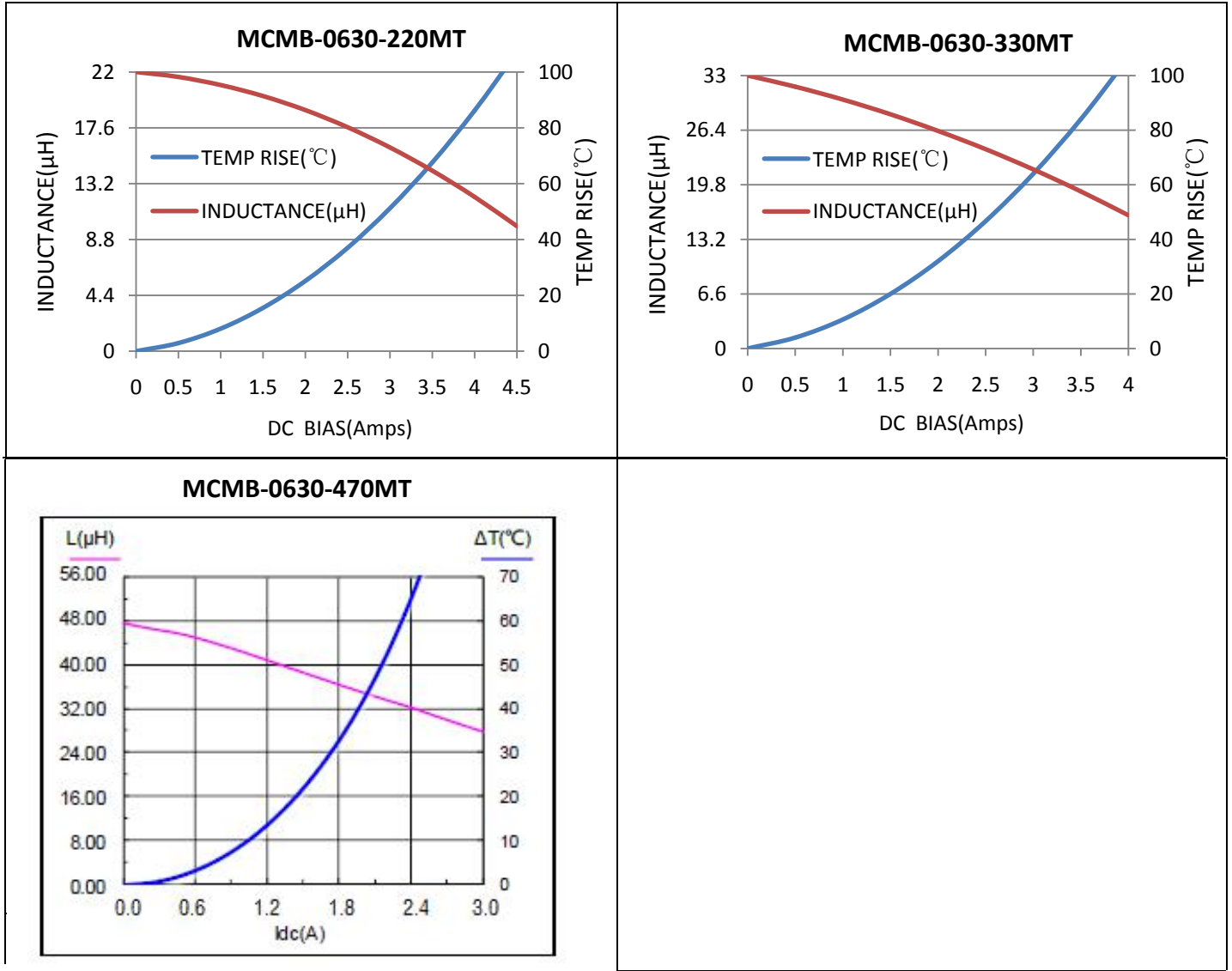

Reliability and Test Condition

Mechanical Reliability		
Item	Specification and Requirement	Test Method
Solderability	The surface of terminal immersed shall be minimum of 95% covered with a new coating of solder	Solder heat proof: 1. Preheating: $160 \pm 10 \text{ }^\circ\text{C}$ 2. Retention time: $245 \pm 5 \text{ }^\circ\text{C}$ for 2 ± 0.5 seconds
Vibration	Inductance change: Within $\pm 10\%$ Without mechanical damage such as break	1. Vibration frequency: (10 Hz to 55 Hz to 10Hz) in 60 seconds as a period 2. Vibration time: Period cycled for 2 hours in each of 3 mutual perpendicular directions. 3. Amplitude: 1.5 mm max.
Shock	Inductance change: Within $\pm 10\%$ Without mechanical damage such as break	1. Peak value: 100 G 2. Duration of pulse: 11ms 3. 3 times in each positive and negative direction of 3 mutual perpendicular directions
Endurance Reliability		
Item	Specification and Requirement	Test Method
Thermal Shock	Inductance change: Within $\pm 10\%$ Without distinct damage in appearance	1. Repeat 100 cycles as follow: ($-55 \pm 2 \text{ }^\circ\text{C}$; 30 ± 3 min) →(Room temp., 5 min) → ($+125 \pm 2 \text{ }^\circ\text{C}$, 30 ± 3 min) → (Room temp., 5 min) 2. Recovery: $48 + 4 / -0$ hours of recovery under the standard condition after the test.
High Temperature Resistance	Inductance change: Within $\pm 10\%$ Without distinct damage in appearance	1. Environment condition: $85 \pm 2 \text{ }^\circ\text{C}$ Applied Current: Rated current 2. Duration: $1000 + 4 / -0$ hours
Humidity Resistance	Inductance change: Within $\pm 10\%$ Without distinct damage in appearance	1. Environment condition: $60 \pm 2 \text{ }^\circ\text{C}$ Humidity: 90–95% Applied Current: Rated current 2. Duration: $1000 + 4 / -0$ hours
Low Temperature Store	Inductance change: Within $\pm 10\%$ Without distinct damage in appearance	Store temperature: $-55 \pm 2 \text{ }^\circ\text{C}$, $1000 + 4 / -0$ hours
High Temperature Store	Inductance change: Within $\pm 10\%$ Without distinct damage in appearance	Store temperature: $+125 \pm 2 \text{ }^\circ\text{C}$, $1000 + 4 / -0$ hours

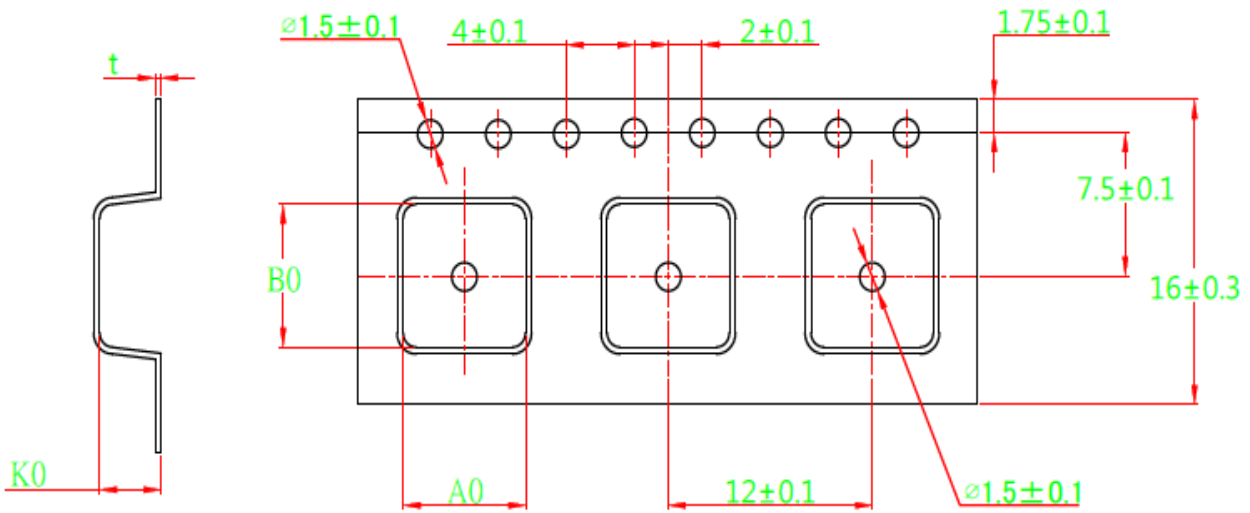
Tape Packaging Dimensions

A0	B0	K0	t
7.2 ± 0.10	7.5 ± 0.10	3.6 ± 0.15	0.31 ± 0.05

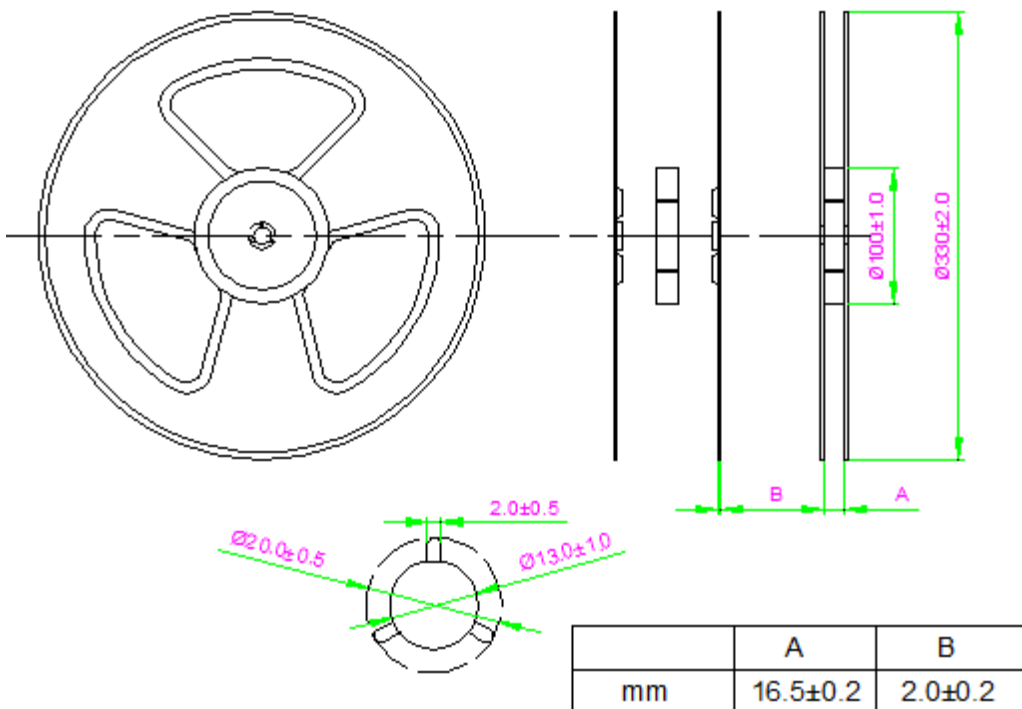
Reel Dimensions

Packaging Quantity: 1000PCS/Reel

Recommended reflow soldering curve:

