

Single color electrical schematic diagram  
单色电气原理图

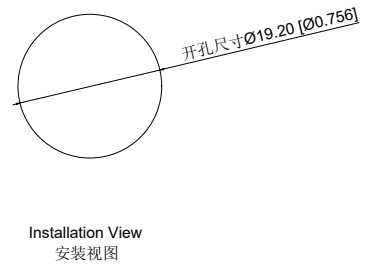

Installation View  
安装视图

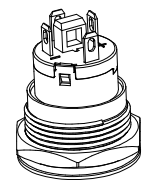

A4				
A3				
A2				
A1				
REV	DATE	REVISION	DESCRIPTION	ISSUE



COMMON TOLERANCE	
X.XX	± 0.10
X.X	± 0.15
X	± 0.25
ANGULAR	—

UNIT	MM	PROJECTED	
DRAWN BY	FUYUAN	CHECKED BY	COCO
DATE	2019	APPROVAL B	ALEN

PRODUCT NAME:
MODEL NO: TP91931P224RA5150
Https: www.rocpcu.tw

**ROCPCU TECHNOLOGY CO., LTD**

Copies are issued in strict confidence and shall not be reproduced or copied, or used as the basis of manufacture or sale of apparatus without permission



性能参数

1. Heating current: Ui: AC250V, Ith: 5A  
发热电流: Ui: AC250V, Ith: 5A
2. Rated current:3A/DC36V  
额定电流:3A/DC36V
3. Power-frequency withstand voltage:1500V1min  
工频耐压:1500V1min
4. Insulation resistance:≥1000MΩ  
绝缘电阻 :≥1000MΩ
5. Contact resistance:≤50mΩ  
接触电阻 :≤50mΩ
6. Pressing stroke:2.80mm ± 0.10  
按压行程:2.80mm ± 0.10
7. Contact stroke:1.00mm±0.10  
接触行程 :1.00mm±0.10
8. Nut assembly torque:5-14N  
螺帽装配力矩:5-14N
9. Protection level:IP67  
防护等级:IP67
10. Explosion prevention level: IK10  
防暴等级: IK10
11. Working environment temperature: -20 °C~+55 °C  
工作环境温度: -20 °C~+55 °C
12. Compression torque: ≤ 4N  
按压扭力: ≤4N

13. Electrical life: 500000 cycles  
电气寿命: 500000 cycles
14. mechanical: 500000cycles  
机械寿命: 500000cycles
15. Operation method:Self repeating form  
操作方式: 自复式
16. NO reverse thrust foot torque: ≤30N  
NO反推脚扭力: ≤30N
17. LED lamp power consumption: 20m以下  
LED灯功耗: 20m以下
18. LED lamp lifespan: 40000h  
LED寿命: 40000h
19. LED color: Red  
LED颜色: 红色



连接形式

1. Welding temperature of wire: 320 ± 20 °C  
线材焊接温度: 320±20°C  
Wire welding duration: less than 3 seconds  
线材焊接时长: 时长3秒以下
2. Can be used with dedicated connectors:  
可配专用接插件使用:
  - 2.1 Switch function wire: Blue wire (NO)  
开关功能线材: 蓝线 (NO)
  - 2.3 LED functional wires: red wire positive pole, black wire negative pole, LED without distinguishing positive and negative poles  
LED功能线材: 红线正极、黑线负极、LED不分正负极

A4				 <b>台普</b> <b>ROCPCU</b>	COMMON TOLERANCE		UNIT	MM	PROJECTED		PRODUCT NAME:
A3					X.XX	± 0.10	DRAWN BY	FUYUAN	CHECKED BY	COCO	MODEL NO: TP91931P224RA5150
A2					X.X	± 0.15	DATE	2019	APPROVAL B	ALEN	Https: www.rocpcu.tw
A1					X	± 0.25	ROCPCU TECHNOLOGY CO.,LTD				
REV	DATE	REVISION	DESCRIPTION		ISSUE	ANGULAR					
	A		B		C		D	E	F	G	

A		B		C		D		E		F		G	
<b>材质参数</b>													
1	9	LEDpin LED引脚	Brass 黄铜	1	Silvering 镀银								
2	8	luminous zone 发光区	PC 塑料	1									
2	7	Pin 引脚	Brass 黄铜	1	Silvering 镀银								
3	6	Contact material 接触材质	silver alloy 银合金	1	Silvering 镀银								
3	5	Base 基座	PA66	1									
3	4	Arm nut 固定螺帽	Brass 黄铜	1	nickeling 镀镍								
4	3	Oring O型圈	Silica gel 硅胶	1									
4	2	Housing 外壳	Aluminum alloy 铝合金	1	Oxidized/Black 氧化/黑色								
4	1	Key 按键	Aluminum alloy 铝合金	1	Oxidized/Black 氧化/黑色								
	NO 序号	Part name 部件名	Material 材料	QTY 数量	Remark 备注								
A4													
A3													
A2													
A1													
REV	DATE	REVISION	DESCRIPTION	ISSUE									
A		B		C		D		E		F		G	

A4		A3		A2		A1		REV		DATE		REVISION		DESCRIPTION		ISSUE			
 <b>台普</b> <b>ROCPCU</b>				COMMON TOLERANCE				UNIT		MM		PROJECTED				PRODUCT NAME:			
				X.XX		± 0.10		DRAWN BY		FUYUAN		CHECKED BY		COCO		MODEL NO: TP91931P224RA5150			
				X.X		± 0.15		DATE		2019		APPROVAL B		ALEN		Https: www.rocpcu.tw			
				X		± 0.25		<b>ROCPCU TECHNOLOGY CO.,LTD</b>											
ANGULAR				—				Copies are issued in strict confidence and shall not be reproduced or copied, or used as the basic of manufacture or sale of apparatus without permission											
A		B		C		D		E		F		G							

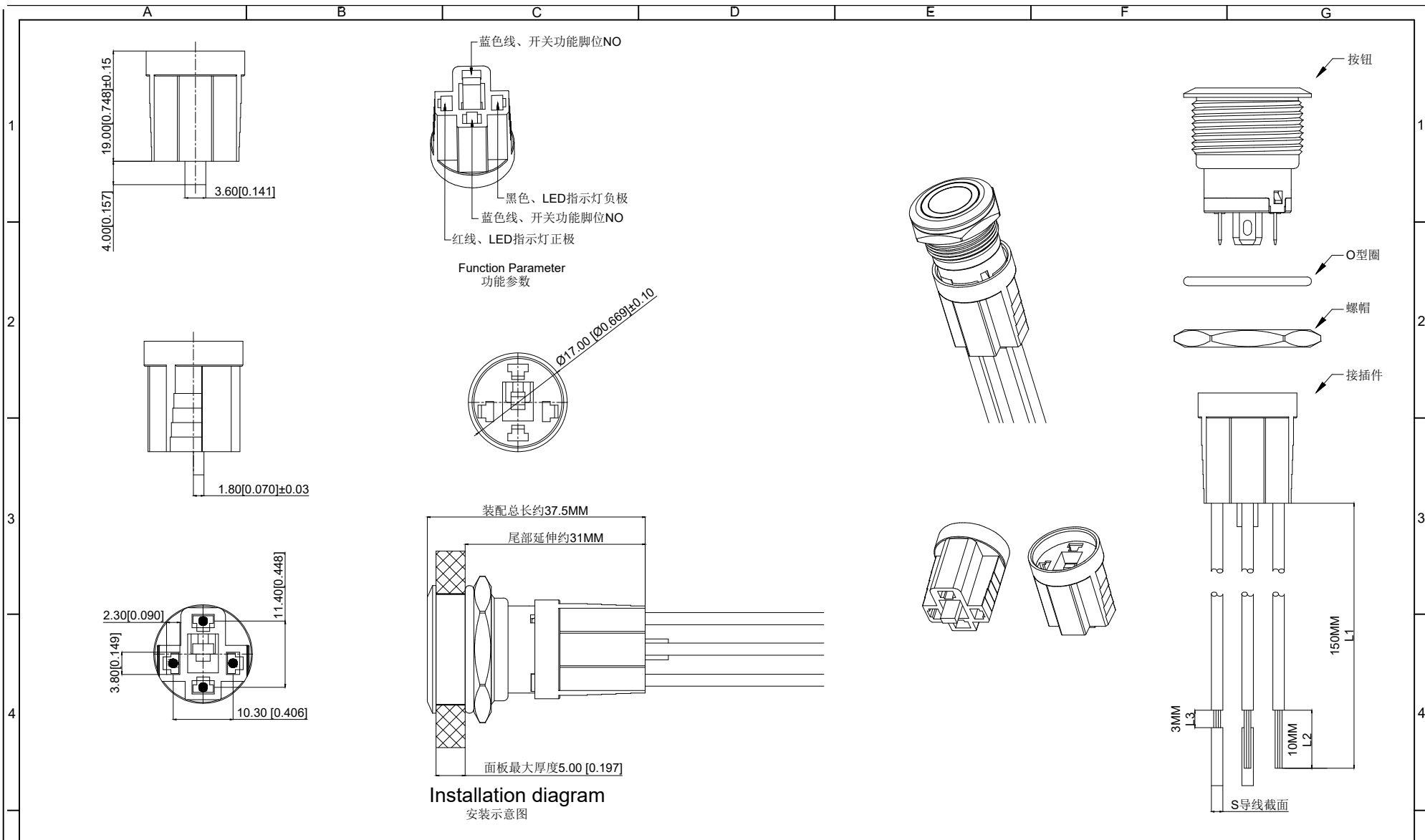

A4				
A3				
A2				
A1				
REV	DATE	REVISION	DESCRIPTION	ISSUE



COMMON TOLERANCE

X.XX	± 0.10
X.X	± 0.15
X	± 0.25
ANGULAR	—

UNIT	MM	PROJECTED		PRODUCT NAME:
DRAWN BY	FUYUAN	CHECKED BY	COCO	MODEL NO: TP91931P224RA5150
DATE	2019	APPROVAL B	ALEN	Https: www.rocpu.tw
<b>ROCPCU TECHNOLOGY CO.,LTD</b>				
Copies are issued in strict confidence and shall not be reproduced or copied, or used as the basic of manufacture or sale of apparatus without permission				

A B C D E F G

性能参数



- 1.L1-导线长度：默认150MM长；
- 2.L2-线头长度：默认10MM
- 3.L3-剥头长度：默认3MM
- 4.S-导线导体横截面积：默认0.5平方MM、可选0.3平方MM
- 5.线型拉力N：（0.15-0.25MM<sup>2</sup>）≤30N、（0.3MM<sup>2</sup>）≤40N、（0.5MM<sup>2</sup>）≤50N、（0.75MM<sup>2</sup>）≤60N
- 6.需要其他线长、线型、可以定

材质参数

- 1.插壳：浅蓝色尼龙胶壳
- 2.端子：磷铜y镀锡色
- 3.导电线材：紫铜

线束使用说明

- 1.2线：用于单色指示灯、无开关功能
- 2.2线：用于1NO开关、无指示灯功能
- 3.4线：用于1NO开关、单色指示灯带灯开关功能

A4				 <b>台普</b> <b>ROCPCU</b>	COMMON TOLERANCE		UNIT	MM	PROJECTED		PRODUCT NAME:
A3					X.XX	± 0.10	DRAWN BY	FUYUAN	CHECKED BY	COCO	MODEL NO: TP91931P224RA5150
A2					X.X	± 0.15	DATE	2019	APPROVAL B	ALEN	Https: www.rocpu.tw
A1					X	± 0.25	ROCPCU TECHNOLOGY CO.,LTD				
REV	DATE	REVISION	DESCRIPTION		ISSUE	ANGULAR					
		A	B	C	D	E	F	G			

