

## Power MOSFET, 40 A

**SOT-227**

### FEATURES

- Fully isolated package
- Easy to use and parallel
- Low on-resistance
- Dynamic dV/dt rating
- Fully avalanche rated
- Simple drive requirements
- Low drain to case capacitance
- Low internal inductance
- UL approved file E78996 
- Designed for industrial level
- Material categorization: for definitions of compliance please see [www.vishay.com/doc?99912](http://www.vishay.com/doc?99912)

**RoHS  
COMPLIANT**

PRIMARY CHARACTERISTICS	
$V_{DSS}$	500 V
$R_{DS(on)}$	106 m $\Omega$
$I_D$	40 A
Type	Modules - MOSFET
Package	SOT-227

### DESCRIPTION

Third generation power MOSFETs from Vishay Semiconductors provide the designer with the best combination of fast switching, ruggedized device design, low on-resistance and cost-effectiveness.

The SOT-227 package is universally preferred for all commercial-industrial applications at power dissipation levels to approximately 500 W. The low thermal resistance of the SOT-227 contribute to its wide acceptance throughout the industry.

ABSOLUTE MAXIMUM RATINGS				
PARAMETER	SYMBOL	TEST CONDITIONS	MAX.	UNITS
Continuous drain current at $V_{GS}$ 10 V	$I_D$	$T_C = 25\text{ }^\circ\text{C}$	40	A
		$T_C = 90\text{ }^\circ\text{C}$	29	
Pulsed drain current	$I_{DM}^{(1)}$		150	
Power dissipation	$P_D$	$T_C = 25\text{ }^\circ\text{C}$	543	W
		$T_C = 90\text{ }^\circ\text{C}$	261	
Gate to source voltage	$V_{GS}$		$\pm 20$	V
Single pulse avalanche energy	$E_{AS}^{(2)}$		400	mJ
Repetitive avalanche current	$I_{AR}^{(1)}$		13	A
Repetitive avalanche energy	$E_{AR}^{(1)}$		42	mJ
Peak diode recovery dV/dt	dV/dt <sup>(3)</sup>		10	V/ns
Operating junction and storage temperature range	$T_J, T_{Stg}$		-55 to +150	$^\circ\text{C}$
Insulation withstand voltage (AC-RMS)	$V_{ISO}$		2.5	kV
Mounting torque		M4 screw, on terminals and heatsink	1.3	Nm

#### Notes

- (1) Repetitive rating; pulse width limited by maximum junction temperature (see fig. 18)  
 (2) Starting  $T_J = 25\text{ }^\circ\text{C}$ ,  $L = 500\text{ }\mu\text{H}$ ,  $R_g = 2.4\text{ }\Omega$ ,  $I_{AS} = 40\text{ A}$  (see fig. 18)  
 (3)  $I_{SD} \leq 40\text{ A}$ ,  $dI_F/dt \leq 200\text{ A}/\mu\text{s}$ ,  $V_{DD} \leq V_{(BR)DSS}$ ,  $T_J \leq 150\text{ }^\circ\text{C}$



THERMAL - MECHANICAL SPECIFICATIONS						
PARAMETER	SYMBOL	TEST CONDITIONS	MIN.	TYP.	MAX.	UNITS
Junction and storage temperature range	$T_J, T_{Stg}$		-55	-	150	°C
Junction to case	$R_{thJC}$		-	-	0.23	°C/W
Case to heatsink	$R_{thCS}$	Flat, greased surface	-	0.05	-	
Weight			-	30	-	g
Mounting torque		Torque to terminal	-	-	1.1 (9.7)	Nm (lbf.in)
		Torque to heatsink	-	-	1.8 (15.9)	Nm (lbf.in)
Case style			SOT-227			

ELECTRICAL CHARACTERISTICS ( $T_J = 25\text{ °C}$ unless otherwise noted)						
PARAMETER	SYMBOL	TEST CONDITIONS	MIN.	TYP.	MAX.	UNITS
Drain to source breakdown voltage	$V_{(BR)DSS}$	$V_{GS} = 0\text{ V}, I_D = 1.0\text{ mA}$	500	-	-	V
Breakdown voltage temperature coefficient	$\Delta V_{(BR)DSS}/\Delta T_J$	Reference to $25\text{ °C}, I_D = 1\text{ mA}$	-	0.65	-	V/°C
Static drain to source on-resistance	$R_{DS(on)}^{(1)}$	$V_{GS} = 10\text{ V}, I_D = 23\text{ A}$	-	106	130	mΩ
Gate threshold voltage	$V_{GS(th)}$	$V_{DS} = V_{GS}, I_D = 250\text{ }\mu\text{A}$	2	3	4	V
		$V_{DS} = V_{GS}, I_D = 250\text{ }\mu\text{A}, T_J = 125\text{ °C}$	-	1.9	-	
Forward transconductance	$g_{fs}$	$V_{DS} = 50\text{ V}, I_D = 23\text{ A}$	-	29	-	S
Drain to source leakage current	$I_{DSS}$	$V_{DS} = 500\text{ V}, V_{GS} = 0\text{ V}$	-	0.5	50	μA
		$V_{DS} = 500\text{ V}, V_{GS} = 0\text{ V}, T_J = 125\text{ °C}$	-	30	500	
		$V_{DS} = 500\text{ V}, V_{GS} = 0\text{ V}, T_J = 150\text{ °C}$	-	0.2	3	mA
Gate to source forward leakage	$I_{GSS}$	$V_{GS} = 20\text{ V}$	-	-	200	nA
Gate to source reverse leakage		$V_{GS} = -20\text{ V}$	-	-	-200	
Total gate charge	$Q_g$	$I_D = 38\text{ A}$	-	280	420	nC
Gate to source charge	$Q_{gs}$	$V_{DS} = 400\text{ V}$	-	37	55	
Gate to drain ("Miller") charge	$Q_{gd}$	$V_{GS} = 10\text{ V}$ ; see fig. 15 and 19 <sup>(1)</sup>	-	150	220	
Turn-on delay time	$t_{d(on)}$	$V_{DD} = 250\text{ V}, I_D = 40\text{ A}, R_g = 2.4\text{ }\Omega,$ $L = 500\text{ }\mu\text{H},$ diode used: 60APH06	-	143	-	ns
Rise time	$t_r$		-	33	-	
Turn-off delay time	$t_{d(off)}$		-	107	-	
Fall time	$t_f$		-	36	-	
Turn-on delay time	$t_{d(on)}$	$V_{DD} = 250\text{ V}, I_D = 40\text{ A}, R_g = 2.4\text{ }\Omega,$ $L = 500\text{ }\mu\text{H}, T_J = 125\text{ °C},$ diode used: 60APH06	-	145	-	ns
Rise time	$t_r$		-	35	-	
Turn-off delay time	$t_{d(off)}$		-	110	-	
Fall time	$t_f$		-	40	-	
Internal source inductance	$L_S$	Between lead, and center of die contact	-	5	-	nH
Input capacitance	$C_{iss}$	$V_{GS} = 0\text{ V}$	-	6900	-	pF
Output capacitance	$C_{oss}$	$V_{DS} = 25\text{ V}$	-	1600	-	
Reverse transfer capacitance	$C_{rss}$	$f = 1.0\text{ MHz}$ , see fig. 14	-	580	-	

**Note**

<sup>(1)</sup> Pulse width  $\leq 300\text{ }\mu\text{s}$ , duty cycle  $\leq 2\%$

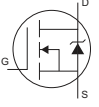
SOURCE-DRAIN RATINGS AND CHARACTERISTICS						
PARAMETER	SYMBOL	TEST CONDITIONS	MIN.	TYP.	MAX.	UNITS
Continuous source current (body diode)	$I_S$	MOSFET symbol showing the integral reverse p-n junction diode. 	-	-	38	A
Pulsed source current (body diode)	$I_{SM}^{(1)}$		-	-	150	
Diode forward voltage	$V_{SD}^{(2)}$	$T_J = 25\text{ }^\circ\text{C}, I_S = 38\text{ A}, V_{GS} = 0\text{ V}$	-	0.9	1.31	V
		$T_J = 125\text{ }^\circ\text{C}, I_S = 38\text{ A}, V_{GS} = 0\text{ V}$	-	0.75	-	
Reverse recovery time	$t_{rr}$	$T_J = 25\text{ }^\circ\text{C}, I_F = 40\text{ A}; dI_F/dt = 100\text{ A}/\mu\text{s}^{(2)}$	-	560	-	ns
Reverse recovery current	$I_{rr}$		-	40	-	A
Reverse recovery charge	$Q_{rr}$		-	11	-	$\mu\text{C}$
Reverse recovery time	$t_{rr}$	$T_J = 25\text{ }^\circ\text{C}, I_F = 40\text{ A}; dI_F/dt = 100\text{ A}/\mu\text{s}^{(2)}$	-	680	-	ns
Reverse recovery current	$I_{rr}$		-	47	-	A
Reverse recovery charge	$Q_{rr}$		-	16	-	$\mu\text{C}$
Forward turn-on time	$t_{on}$	Intrinsic turn-on time is negligible (turn-on is dominated by $L_S + L_D$ )				

**Notes**

- (1) Repetitive rating; pulse width limited by maximum junction temperature (see fig. 18)
- (2) Pulse width  $\leq 300\text{ }\mu\text{s}$ , duty cycle  $\leq 2\%$

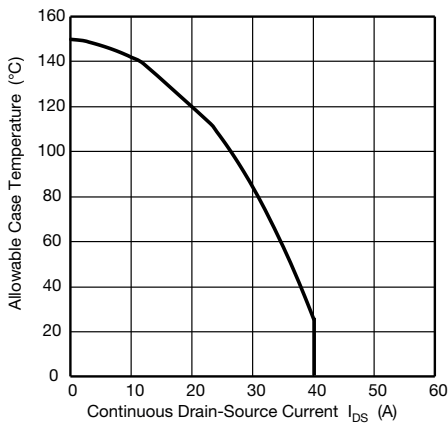

Fig. 1 - Maximum DC MOSFET Drain-Source Current vs. Case Temperature

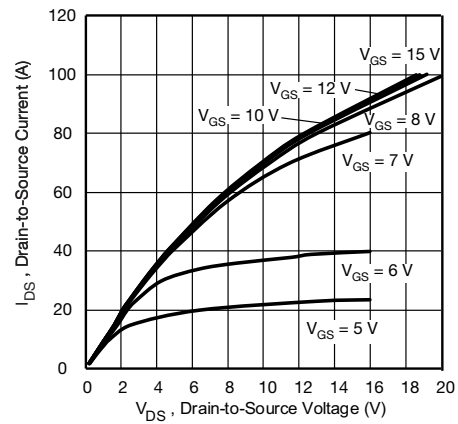

Fig. 3 - Typical Drain-to-Source Current Output Characteristics at  $T_J = 25\text{ }^\circ\text{C}$

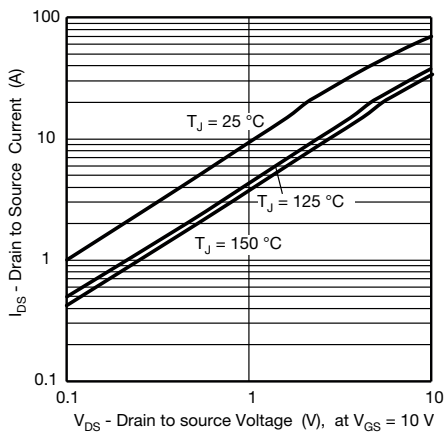

Fig. 2 - Typical Drain-to-Source Current Output Characteristics;  $V_{GS} = 10\text{ V}$

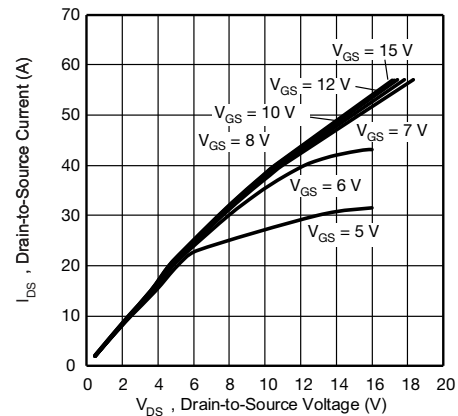

Fig. 4 - Typical Drain-to-Source Current Output Characteristics at  $T_J = 125\text{ }^\circ\text{C}$

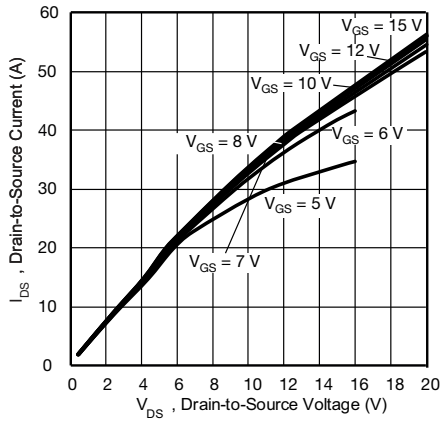

Fig. 5 - Typical Drain-to-Source Current Output Characteristics at  $T_J = 150\text{ }^\circ\text{C}$

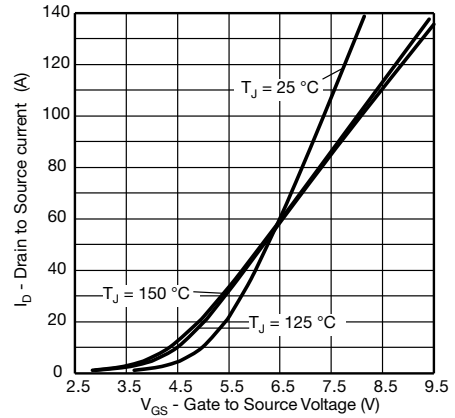

Fig. 8 - Typical MOSFET Transfer Characteristics

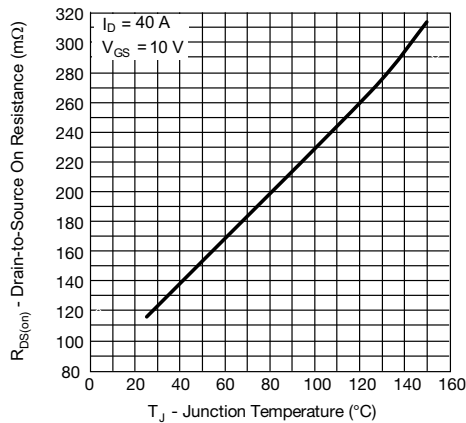

Fig. 6 - Normalized On-Resistance vs. Temperature

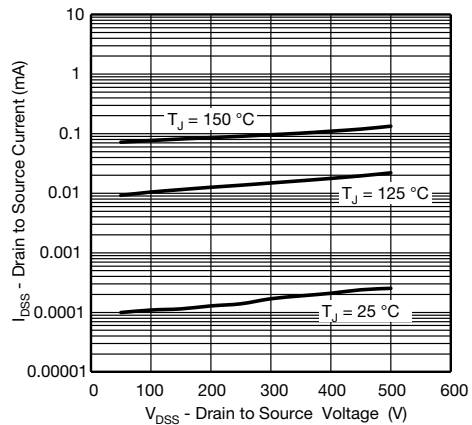

Fig. 9 - Typical MOSFET Zero Gate Voltage Drain Current

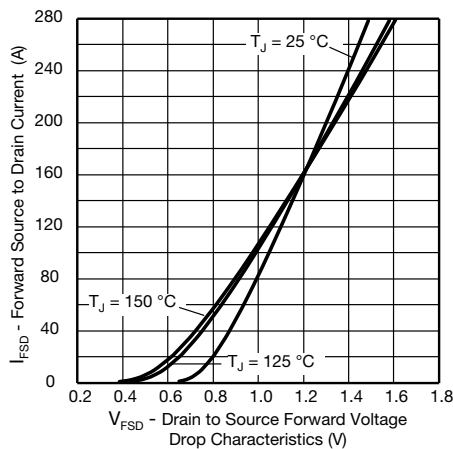

Fig. 7 - Typical Body Diode Forward Voltage Drop Characteristics

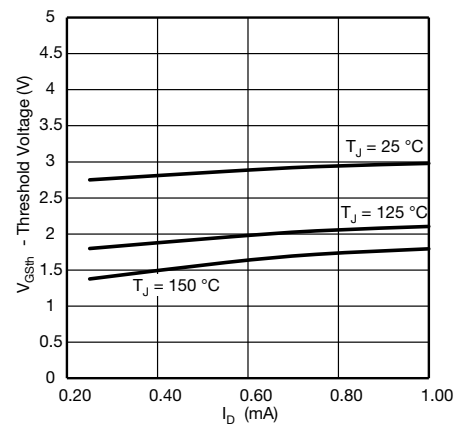

Fig. 10 - Typical MOSFET Threshold Voltage

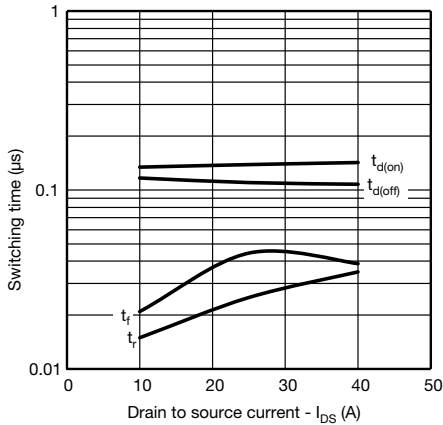

Fig. 11 - Typical MOSFET Switching Time vs.  $I_{DS}$ ,  $T_J = 125\text{ }^\circ\text{C}$ ,  $V_{DD} = 250\text{ V}$ ,  $V_{GS} = 10\text{ V}$ ,  $L = 500\text{ }\mu\text{H}$ ,  $R_G = 2.4\text{ }\Omega$   
Diode used 60APH06

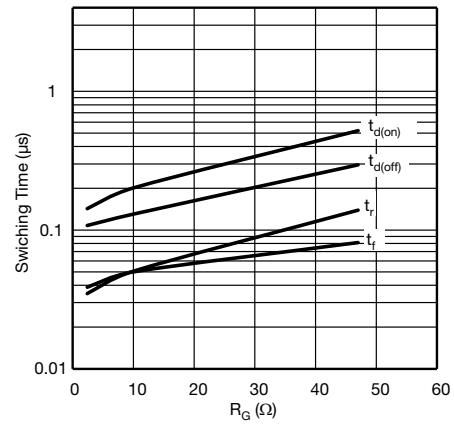

Fig. 12 - Typical MOSFET Switching Time vs.  $R_G$ ,  $T_J = 125\text{ }^\circ\text{C}$ ,  $I_{DS} = 40\text{ A}$ ,  $V_{DD} = 250\text{ V}$ ,  $V_{GS} = 10\text{ V}$ ,  $L = 500\text{ }\mu\text{H}$   
Diode used 60APH06

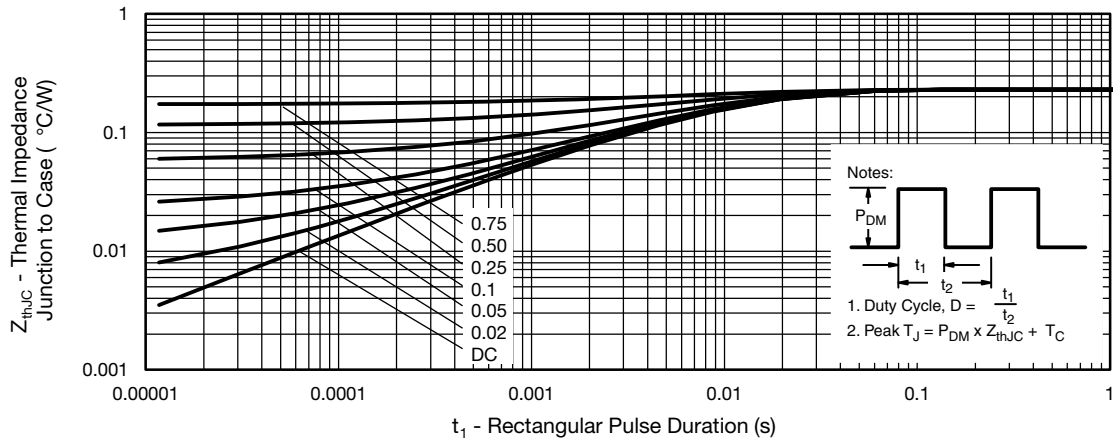

Fig. 13 - Maximum Thermal Impedance  $Z_{thJC}$  Characteristics, MOSFET

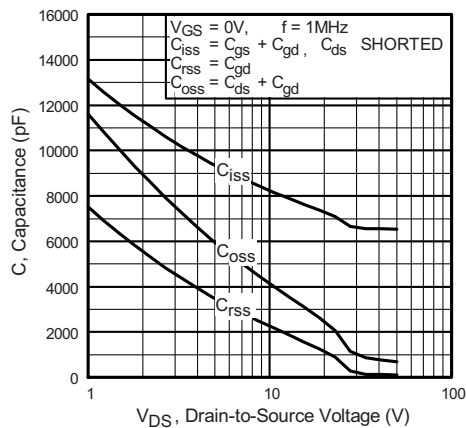

Fig. 14 - Typical Capacitance vs. Drain to Source Voltage

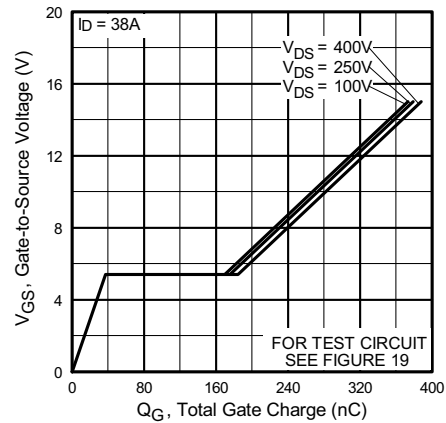

Fig. 15 - Typical Gate Charge vs. Gate to Source Voltage

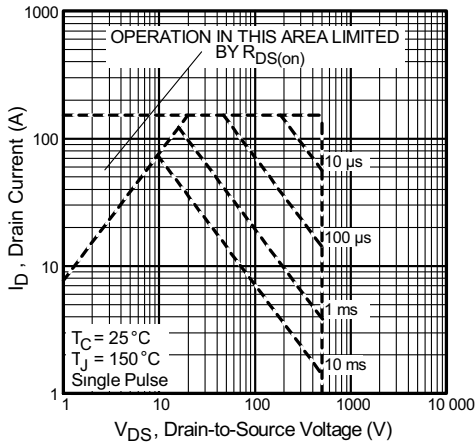

Fig. 16 - Maximum Safe Operating Area

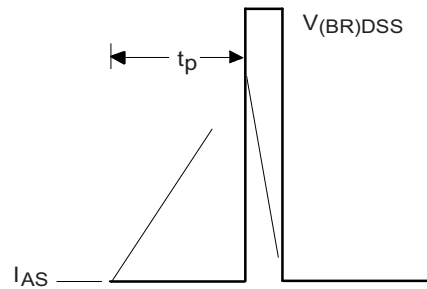

Fig. 20 - Unclamped Inductive Waveforms

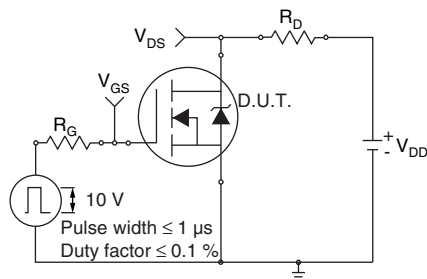

Fig. 17 - Switching Time Test Circuit

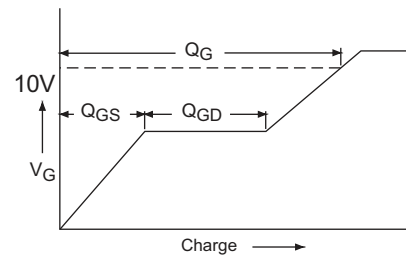

Fig. 21 - Basic Gate Charge Waveform

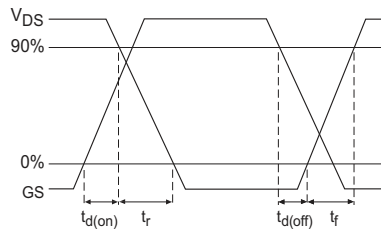

Fig. 18 - Switching Time Waveforms

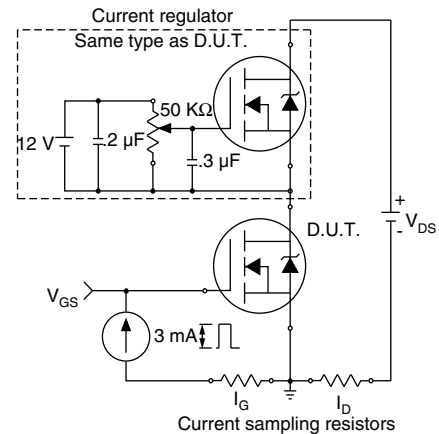

Fig. 22 - Gate Charge Test Circuit

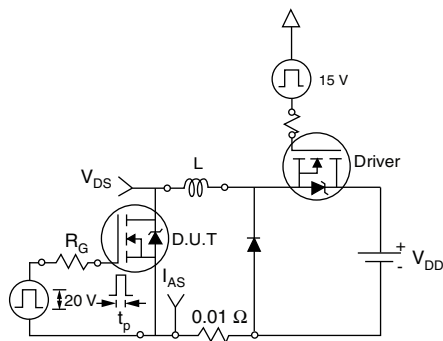

Fig. 19 - Unclamped Inductive Test Circuit

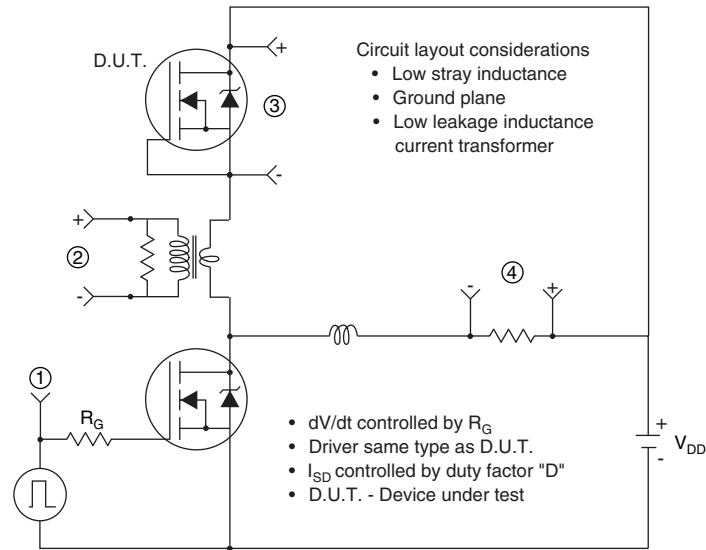
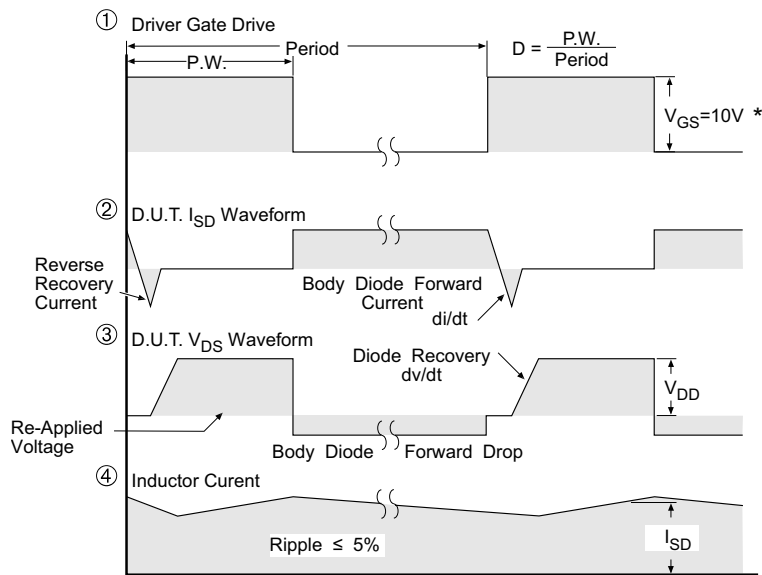

Fig. 23 - Peak Diode Recovery  $dv/dt$  Test Circuit



\*  $V_{GS} = 5V$  for Logic Level Devices

Fig. 24 - For N-Channel Power MOSFETs

## ORDERING INFORMATION TABLE

Device code	<b>VS-</b>	<b>F</b>	<b>A</b>	<b>40</b>	<b>S</b>	<b>A</b>	<b>50</b>	<b>LC</b>
	①	②	③	④	⑤	⑥	⑦	⑧

- 1** - Vishay Semiconductors product
- 2** - Power MOSFET
- 3** - A = generation 3, MOSFET silicon die
- 4** - Current rating (40 = 40 A)
- 5** - Single switch
- 6** - Package indicator (SOT-227)
- 7** - Voltage rating (50 = 500 V)
- 8** - LC = low charge

CIRCUIT CONFIGURATION		
CIRCUIT	CIRCUIT CONFIGURATION CODE	CIRCUIT DRAWING
Single switch	S	

LINKS TO RELATED DOCUMENTS	
Dimensions	<a href="http://www.vishay.com/doc?95423">www.vishay.com/doc?95423</a>
Packaging information	<a href="http://www.vishay.com/doc?95425">www.vishay.com/doc?95425</a>





## SOT-227 Generation 2

**DIMENSIONS** in millimeters (inches)



**Note**

- Controlling dimension: millimeter



## Disclaimer

ALL PRODUCT, PRODUCT SPECIFICATIONS AND DATA ARE SUBJECT TO CHANGE WITHOUT NOTICE TO IMPROVE RELIABILITY, FUNCTION OR DESIGN OR OTHERWISE.

Vishay Intertechnology, Inc., its affiliates, agents, and employees, and all persons acting on its or their behalf (collectively, "Vishay"), disclaim any and all liability for any errors, inaccuracies or incompleteness contained in any datasheet or in any other disclosure relating to any product.

Vishay makes no warranty, representation or guarantee regarding the suitability of the products for any particular purpose or the continuing production of any product. To the maximum extent permitted by applicable law, Vishay disclaims (i) any and all liability arising out of the application or use of any product, (ii) any and all liability, including without limitation special, consequential or incidental damages, and (iii) any and all implied warranties, including warranties of fitness for particular purpose, non-infringement and merchantability.

Statements regarding the suitability of products for certain types of applications are based on Vishay's knowledge of typical requirements that are often placed on Vishay products in generic applications. Such statements are not binding statements about the suitability of products for a particular application. It is the customer's responsibility to validate that a particular product with the properties described in the product specification is suitable for use in a particular application. Parameters provided in datasheets and / or specifications may vary in different applications and performance may vary over time. All operating parameters, including typical parameters, must be validated for each customer application by the customer's technical experts. Product specifications do not expand or otherwise modify Vishay's terms and conditions of purchase, including but not limited to the warranty expressed therein.

Hyperlinks included in this datasheet may direct users to third-party websites. These links are provided as a convenience and for informational purposes only. Inclusion of these hyperlinks does not constitute an endorsement or an approval by Vishay of any of the products, services or opinions of the corporation, organization or individual associated with the third-party website. Vishay disclaims any and all liability and bears no responsibility for the accuracy, legality or content of the third-party website or for that of subsequent links.

Except as expressly indicated in writing, Vishay products are not designed for use in medical, life-saving, or life-sustaining applications or for any other application in which the failure of the Vishay product could result in personal injury or death. Customers using or selling Vishay products not expressly indicated for use in such applications do so at their own risk. Please contact authorized Vishay personnel to obtain written terms and conditions regarding products designed for such applications.

No license, express or implied, by estoppel or otherwise, to any intellectual property rights is granted by this document or by any conduct of Vishay. Product names and markings noted herein may be trademarks of their respective owners.