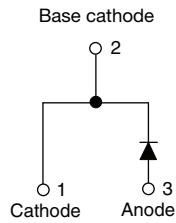

# Hyperfast Rectifier, 15 A FRED Pt® G5

**TO-220AC 2L**

**FEATURES**

- Hyperfast and optimized  $Q_{rr}$
- Best in class forward voltage drop and switching losses trade off
- Optimized for high speed operation
- 175 °C maximum operating junction temperature
- Polyimide passivation
- Material categorization: for definitions of compliance please see [www.vishay.com/doc?99912](http://www.vishay.com/doc?99912)

**RoHS**  
 COMPLIANT  
 HALOGEN  
**FREE**
**LINKS TO ADDITIONAL RESOURCES**

3D Models



Application Notes



Models

PRIMARY CHARACTERISTICS	
$I_{F(AV)}$	15 A
$V_R$	1200 V
$V_F$ at $I_F$ at 125 °C	2.1 V
$t_{rr}$	29 ns
$T_J$ max.	175 °C
Package	TO-220AC 2L
Circuit configuration	Single

**DESCRIPTION / APPLICATIONS**

Featuring a unique combination of low conduction and switching losses, this rectifier is the right choice for high frequency converters, both soft switched / resonant. Specifically designed to improve efficiency of PFC and output rectification stages of EV / HEV battery charging stations, booster stage of solar inverters and UPS applications, these devices are perfectly matched to operate with MOSFETs or high speed IGBTs.

**MECHANICAL DATA**
**Case:** TO-220AC 2L

Molding compound meets UL 94 V-0 flammability rating

**Terminals:** matte tin plated leads, solderable per J-STD-002

**Polarity:** as per marking device details

ABSOLUTE MAXIMUM RATINGS				
PARAMETER	SYMBOL	TEST CONDITIONS	VALUES	UNITS
Repetitive peak reverse voltage	$V_{RRM}$		1200	V
Average rectified forward current	$I_{F(AV)}$	$T_C = 98\text{ °C}, D = 0.50$	15	A
Repetitive peak forward current	$I_{FRM}$	$T_C = 98\text{ °C}, D = 0.50, f = 20\text{ kHz}$	30	
Non-repetitive peak surge current	$I_{FSM}$	$T_C = 45\text{ °C}, t_p = 10\text{ ms}, \text{ sine wave}$	110	
Operating junction and storage temperature	$T_J, T_{Stg}$		-55 to +175	°C

ELECTRICAL SPECIFICATIONS ( $T_J = 25\text{ °C}$ unless otherwise specified)						
PARAMETER	SYMBOL	TEST CONDITIONS	MIN.	TYP.	MAX.	UNITS
Breakdown voltage, blocking voltage	$V_{BR}, V_R$	$I_R = 100\text{ }\mu\text{A}$	1200	-	-	V
Forward voltage	$V_F$	$I_F = 15\text{ A}$ $I_F = 15\text{ A}, T_J = 125\text{ °C}$	-	2.5 2.1	3.3 -	
Reverse leakage current	$I_R$	$V_R = V_R$ rated $T_J = 125\text{ °C}, V_R = V_R$ rated	-	-	50 500	$\mu\text{A}$
Junction capacitance	$C_T$	$V_R = 200\text{ V}$	-	10	-	pF
Series inductance	$L_S$	Measured to lead 5 mm from package body	-	8	-	nH



<b>DYNAMIC RECOVERY CHARACTERISTICS</b> ( $T_J = 25\text{ }^\circ\text{C}$ unless otherwise specified)							
PARAMETER	SYMBOL	TEST CONDITIONS	MIN.	TYP.	MAX.	UNITS	
Reverse recovery time	$t_{rr}$	$I_F = 1.0\text{ A}$ , $di_F/dt = 100\text{ A}/\mu\text{s}$ , $V_R = 30\text{ V}$	-	29	44	ns	
		$T_J = 25\text{ }^\circ\text{C}$	-	96	-		
		$T_J = 125\text{ }^\circ\text{C}$	-	137	-		
Peak recovery current	$I_{RRM}$	$I_F = 10\text{ A}$ $di_F/dt = 600\text{ A}/\mu\text{s}$ $V_R = 400\text{ V}$	$T_J = 25\text{ }^\circ\text{C}$	-	11.5	-	A
			$T_J = 125\text{ }^\circ\text{C}$	-	16	-	
Reverse recovery charge	$Q_{rr}$	$T_J = 25\text{ }^\circ\text{C}$	$T_J = 25\text{ }^\circ\text{C}$	-	375	-	nC
			$T_J = 125\text{ }^\circ\text{C}$	-	900	-	
Reverse recovery time	$t_{rr}$	$T_J = 25\text{ }^\circ\text{C}$	$T_J = 25\text{ }^\circ\text{C}$	-	77.5	-	ns
			$T_J = 125\text{ }^\circ\text{C}$	-	106	-	
Peak recovery current	$I_{RRM}$	$I_F = 15\text{ A}$ $di_F/dt = 1000\text{ A}/\mu\text{s}$ $V_R = 800\text{ V}$	$T_J = 25\text{ }^\circ\text{C}$	-	21	-	A
			$T_J = 125\text{ }^\circ\text{C}$	-	29	-	
Reverse recovery charge	$Q_{rr}$	$T_J = 25\text{ }^\circ\text{C}$	$T_J = 25\text{ }^\circ\text{C}$	-	680	-	nC
			$T_J = 125\text{ }^\circ\text{C}$	-	1600	-	

<b>THERMAL - MECHANICAL SPECIFICATIONS</b>						
PARAMETER	SYMBOL	TEST CONDITIONS	MIN.	TYP.	MAX.	UNITS
Thermal resistance, junction-to-case	$R_{thJC}$		-	-	1.7	$^\circ\text{C}/\text{W}$
Weight			-	2.0	-	g
Mounting torque			6.0 (5.0)	-	12 (10)	kgf · cm (lbf · in)
Maximum junction and storage temperature range	$T_J$ , $T_{Stg}$		-55	-	175	$^\circ\text{C}$
Marking device		Case style TO-220AC 2L	E5TX1512			

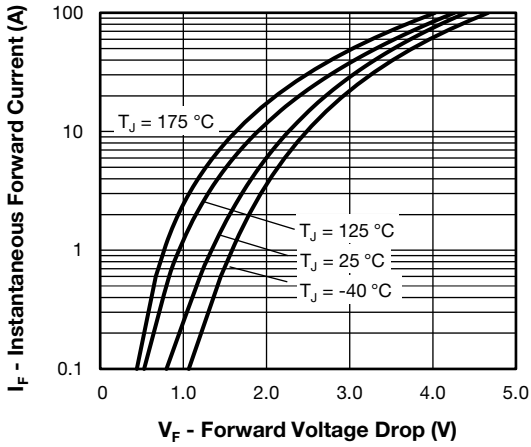

Fig. 1 - Forward Voltage Drop Characteristics

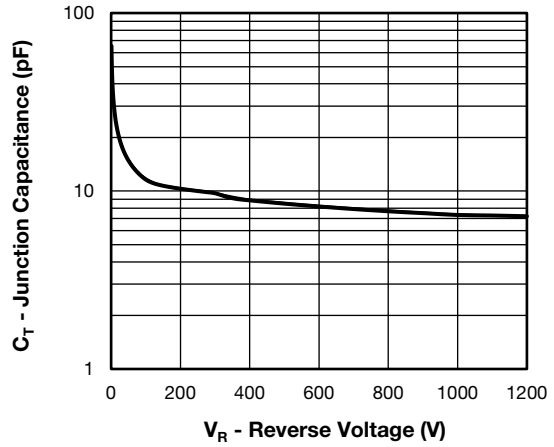

Fig. 3 - Typical Junction Capacitance vs. Reverse Voltage

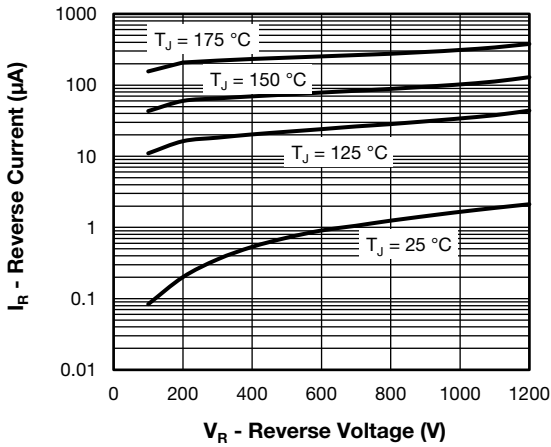

Fig. 2 - Typical Values of Reverse Current vs. Reverse Voltage

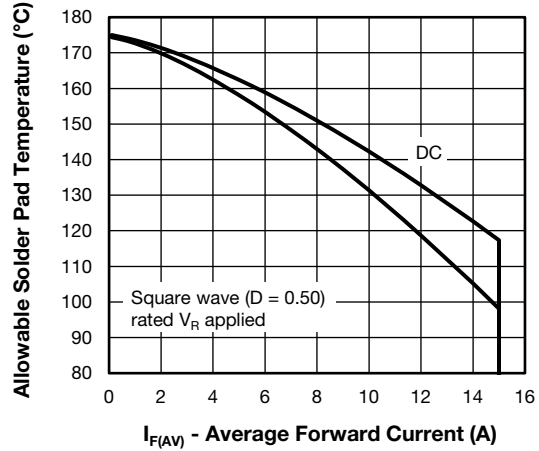

Fig. 4 - Maximum Allowable Case Temperature vs. Average Forward Current

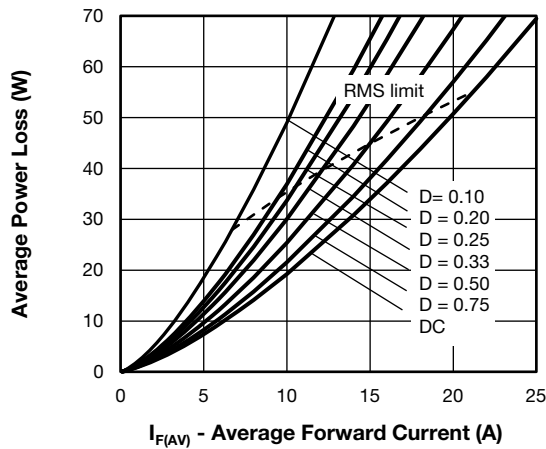

Fig. 5 - Forward Power Loss Characteristics

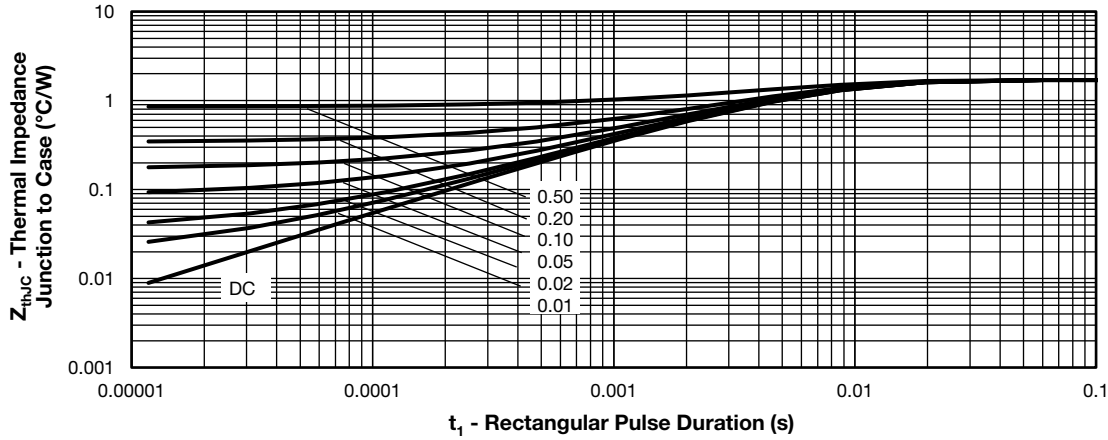

Fig. 6 - Transient Thermal Impedance, Junction to Case

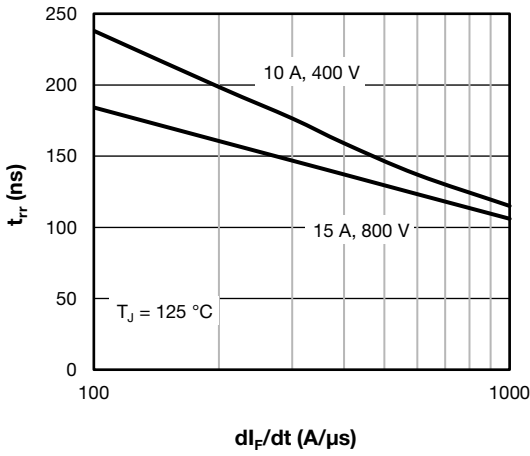

Fig. 7 - Typical Reverse Recovery Time vs.  $dI_F/dt$

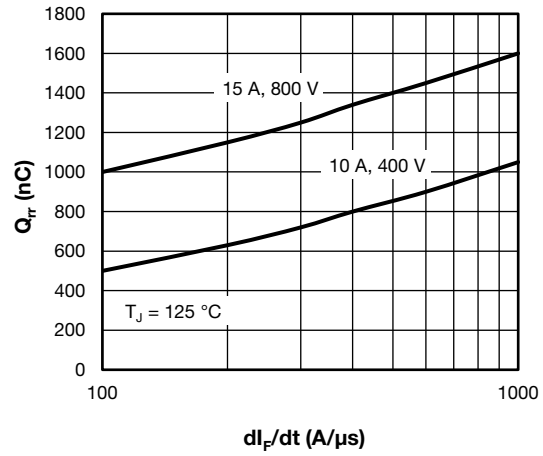

Fig. 8 - Typical Stored Charge vs.  $dI_F/dt$

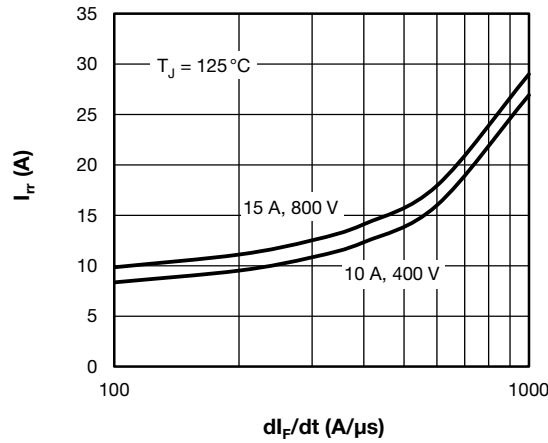

Fig. 9 - Typical Recovery Current vs.  $dI_F/dt$

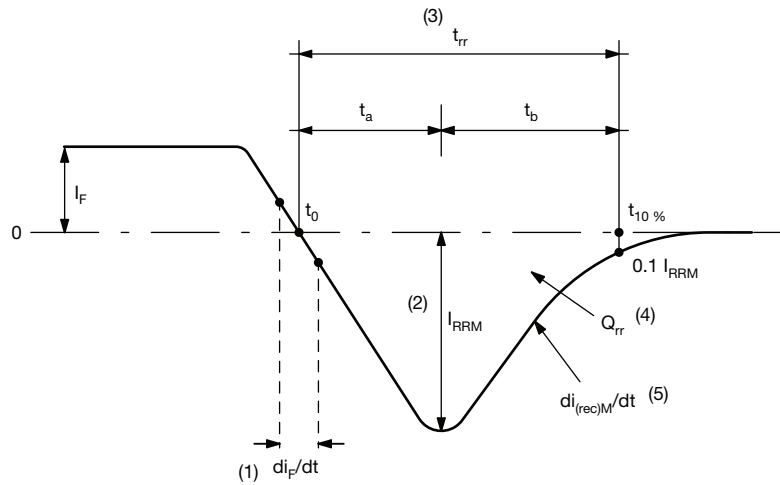

Fig. 10 - Reverse Recovery Waveform and Definitions

**Notes**

- (1)  $di_F/dt$  - rate of change of current through zero crossing
- (2)  $I_{RRM}$  - peak reverse recovery current
- (3)  $t_{rr}$  - reverse recovery time measured from  $t_0$ , crossing point of negative going  $I_F$ , to point  $t_{10\%}$ ,  $0.1 I_{RRM}$
- (4)  $Q_{rr}$  - area under curve defined by  $t_0$  and  $t_{10\%}$

$$Q_{rr} = \int_{t_0}^{t_{10\%}} I(t) dt$$

- (5)  $di_{(rec)M}/dt$  - peak rate of change of current during  $t_b$  portion of  $t_{rr}$



## ORDERING INFORMATION TABLE

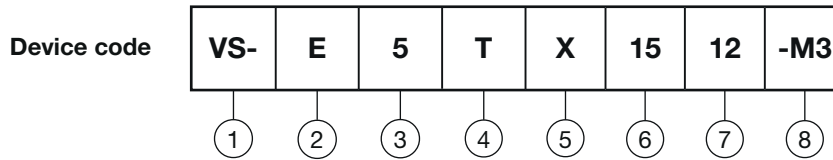

- 1** - Vishay Semiconductors product
- 2** - E = single diode
- 3** - 5 = FRED generation 5
- 4** - Package:  
T = TO-220AC 2L
- 5** - X = hyperfast recovery
- 6** - Current rating (15 = 15 A)
- 7** - Voltage rating (12 = 1200 V)
- 8** - Environmental digit:  
-M3 = halogen-free, RoHS-compliant, and termination lead (Pb)-free

ORDERING INFORMATION (Example)		
PREFERRED P/N	BASE QUANTITY	PACKAGING DESCRIPTION
VS-E5TX1512-M3	50	Antistatic plastic tubes

LINKS TO RELATED DOCUMENTS	
Dimensions	<a href="http://www.vishay.com/doc?96156">www.vishay.com/doc?96156</a>
Part marking information	<a href="http://www.vishay.com/doc?95391">www.vishay.com/doc?95391</a>
SPIICE Model	<a href="http://www.vishay.com/doc?97160">www.vishay.com/doc?97160</a>

### TO-220AB 3L

**DIMENSIONS** in millimeters and inches

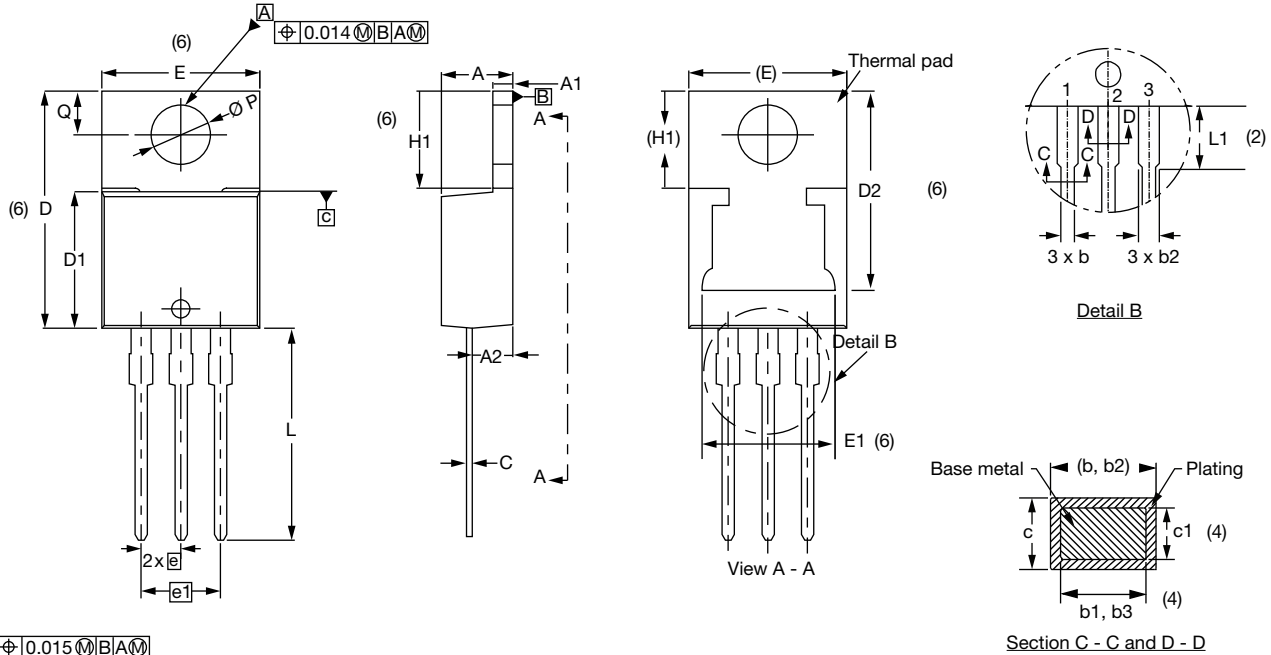

Conforms to JEDEC® outline TO-220AB

SYMBOL	MILLIMETERS		INCHES		NOTES
	MIN.	MAX.	MIN.	MAX.	
A	4.25	4.65	0.167	0.183	
A1	1.14	1.40	0.045	0.055	
A2	2.50	2.92	0.098	0.115	
b	0.69	1.01	0.027	0.040	
b1	0.38	0.97	0.015	0.038	4
b2	1.20	1.73	0.047	0.068	
b3	1.14	1.73	0.045	0.068	4
c	0.36	0.61	0.014	0.024	
c1	0.36	0.56	0.014	0.022	4
D	14.85	15.35	0.585	0.604	3
D1	8.38	9.02	0.330	0.355	
D2	11.68	13.30	0.460	0.524	6, 7
E	10.11	10.51	0.398	0.414	3, 6
E1	6.86	8.89	0.270	0.350	6
e	2.41	2.67	0.095	0.105	
e1	4.88	5.28	0.192	0.208	
H1	6.09	6.48	0.240	0.255	6
L	13.52	14.02	0.532	0.552	
L1	3.32	3.82	0.131	0.150	2
Ø P	3.54	3.91	0.139	0.154	
Q	2.60	3.00	0.102	0.118	

**Notes**

- (1) Dimensioning and tolerancing as per ASME Y14.5M-1994
- (2) Lead dimension and finish uncontrolled in L1
- (3) Dimension D, D1, and E do not include mold flash. Mold flash shall not exceed 0.127 mm (0.005") per side. These dimensions are measured at the outermost extremes of the plastic body
- (4) Dimension b1, b3, and c1 apply to base metal only
- (5) Controlling dimensions: inches
- (6) Thermal pad contour optional within dimensions E, H1, D2, and E1
- (7) Outline conforms to JEDEC® TO-220, except D2

### TO-220AC 2L

**DIMENSIONS** in millimeters and inches

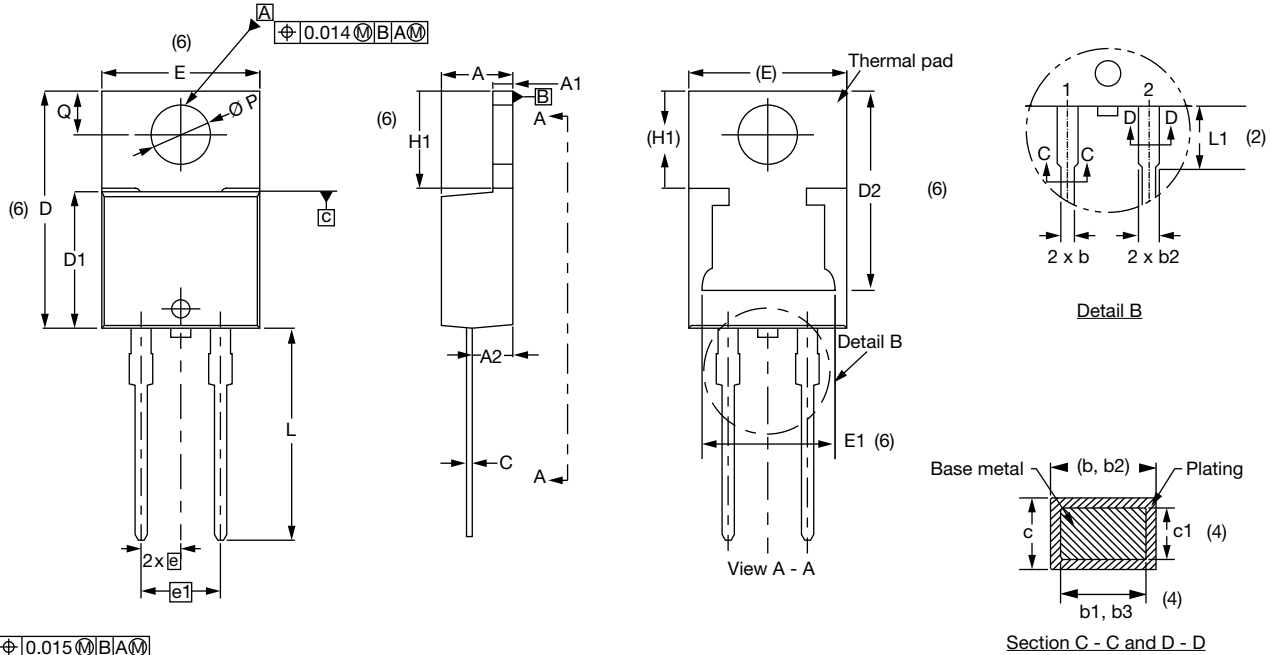

Conforms to JEDEC® outline TO-220AC

SYMBOL	MILLIMETERS		INCHES		NOTES
	MIN.	MAX.	MIN.	MAX.	
A	4.25	4.65	0.167	0.183	
A1	1.14	1.40	0.045	0.055	
A2	2.50	2.92	0.098	0.115	
b	0.69	1.01	0.027	0.040	
b1	0.38	0.97	0.015	0.038	4
b2	1.20	1.73	0.047	0.068	
b3	1.14	1.73	0.045	0.068	4
c	0.36	0.61	0.014	0.024	
c1	0.36	0.56	0.014	0.022	4
D	14.85	15.35	0.585	0.604	3
D1	8.38	9.02	0.330	0.355	
D2	11.68	13.30	0.460	0.524	6, 7
E	10.11	10.51	0.398	0.414	3, 6
E1	6.86	8.89	0.270	0.350	6
e	2.41	2.67	0.095	0.105	
e1	4.88	5.28	0.192	0.208	
H1	6.09	6.48	0.240	0.255	6
L	13.52	14.02	0.532	0.552	
L1	3.32	3.82	0.131	0.150	2
Ø P	3.54	3.91	0.139	0.154	
Q	2.60	3.00	0.102	0.118	

**Notes**

- (1) Dimensioning and tolerancing as per ASME Y14.5M-1994
- (2) Lead dimension and finish uncontrolled in L1
- (3) Dimension D, D1, and E do not include mold flash. Mold flash shall not exceed 0.127 mm (0.005") per side. These dimensions are measured at the outermost extremes of the plastic body
- (4) Dimension b1, b3, and c1 apply to base metal only
- (5) Controlling dimensions: inches
- (6) Thermal pad contour optional within dimensions E, H1, D2, and E1
- (7) Outline conforms to JEDEC® TO-220, except D2





## Disclaimer

ALL PRODUCT, PRODUCT SPECIFICATIONS AND DATA ARE SUBJECT TO CHANGE WITHOUT NOTICE TO IMPROVE RELIABILITY, FUNCTION OR DESIGN OR OTHERWISE.

Vishay Intertechnology, Inc., its affiliates, agents, and employees, and all persons acting on its or their behalf (collectively, "Vishay"), disclaim any and all liability for any errors, inaccuracies or incompleteness contained in any datasheet or in any other disclosure relating to any product.

Vishay makes no warranty, representation or guarantee regarding the suitability of the products for any particular purpose or the continuing production of any product. To the maximum extent permitted by applicable law, Vishay disclaims (i) any and all liability arising out of the application or use of any product, (ii) any and all liability, including without limitation special, consequential or incidental damages, and (iii) any and all implied warranties, including warranties of fitness for particular purpose, non-infringement and merchantability.

Statements regarding the suitability of products for certain types of applications are based on Vishay's knowledge of typical requirements that are often placed on Vishay products in generic applications. Such statements are not binding statements about the suitability of products for a particular application. It is the customer's responsibility to validate that a particular product with the properties described in the product specification is suitable for use in a particular application. Parameters provided in datasheets and / or specifications may vary in different applications and performance may vary over time. All operating parameters, including typical parameters, must be validated for each customer application by the customer's technical experts. Product specifications do not expand or otherwise modify Vishay's terms and conditions of purchase, including but not limited to the warranty expressed therein.

Hyperlinks included in this datasheet may direct users to third-party websites. These links are provided as a convenience and for informational purposes only. Inclusion of these hyperlinks does not constitute an endorsement or an approval by Vishay of any of the products, services or opinions of the corporation, organization or individual associated with the third-party website. Vishay disclaims any and all liability and bears no responsibility for the accuracy, legality or content of the third-party website or for that of subsequent links.

Except as expressly indicated in writing, Vishay products are not designed for use in medical, life-saving, or life-sustaining applications or for any other application in which the failure of the Vishay product could result in personal injury or death. Customers using or selling Vishay products not expressly indicated for use in such applications do so at their own risk. Please contact authorized Vishay personnel to obtain written terms and conditions regarding products designed for such applications.

No license, express or implied, by estoppel or otherwise, to any intellectual property rights is granted by this document or by any conduct of Vishay. Product names and markings noted herein may be trademarks of their respective owners.