

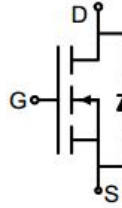
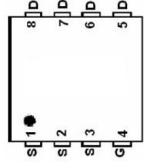

N-Channel Enhancement Mode Power MOSFET

<p>Description</p> <p>The G020N03D5 uses advanced trench technology to provide excellent $R_{DS(ON)}$, low gate charge. It can be used in a wide variety of applications.</p> <p>General Features</p> <ul style="list-style-type: none"> ● V_{DS} 30V ● I_D (at $V_{GS} = 10V$) 140A ● $R_{DS(ON)}$ (at $V_{GS} = 10V$) < 2mΩ ● $R_{DS(ON)}$ (at $V_{GS} = 4.5V$) < 3mΩ ● 100% Avalanche Tested ● RoHS Compliant <p>Application</p> <ul style="list-style-type: none"> ● Power switch ● DC/DC converters 	 <p>Schematic diagram</p>  <p>pin assignment</p>  <p>DFN5X6-8L</p>
---	---

Ordering Information

Device	Package	Marking	Packaging
G020N03D5	DFN5X6-8L	G020N03	5000pcs/Reel

Absolute Maximum Ratings $T_C = 25^\circ C$, unless otherwise noted

Parameter	Symbol	Value	Unit
Drain-Source Voltage	V_{DS}	30	V
Continuous Drain Current	I_D	140	A
Pulsed Drain Current (note1)	I_{DM}	560	A
Gate-Source Voltage	V_{GS}	± 20	V
Power Dissipation	P_D	83	W
Single pulse avalanche energy (note2)	E_{AS}	144	mJ
Operating Junction and Storage Temperature Range	T_J, T_{stg}	-55 To 150	$^\circ C$

Thermal Resistance

Parameter	Symbol	Value	Unit
Thermal Resistance, Junction-to-Ambient	R_{thJA}	50	$^\circ C/W$
Maximum Junction-to-Case	R_{thJC}	1.5	$^\circ C/W$

Specifications $T_J = 25^\circ\text{C}$, unless otherwise noted						
Parameter	Symbol	Test Conditions	Value			Unit
			Min.	Typ.	Max.	
Static Parameters						
Drain-Source Breakdown Voltage	$V_{(BR)DSS}$	$V_{GS} = 0V, I_D = 250\mu A$	30	--	--	V
Zero Gate Voltage Drain Current	I_{DSS}	$V_{DS} = 30V, V_{GS} = 0V$	--	--	1	μA
Gate-Source Leakage	I_{GSS}	$V_{GS} = \pm 20V$	--	--	± 100	nA
Gate-Source Threshold Voltage	$V_{GS(th)}$	$V_{DS} = V_{GS}, I_D = 250\mu A$	1.0	1.5	2.0	V
Drain-Source On-Resistance	$R_{DS(on)}$	$V_{GS} = 10V, I_D = 50A$	--	1.5	2.0	m Ω
		$V_{GS} = 4.5V, I_D = 50A$	--	2.1	3.0	
Forward Transconductance	g_{FS}	$V_{GS} = 5V, I_D = 50A$	--	62	--	S
Dynamic Parameters						
Input Capacitance	C_{iss}	$V_{GS} = 0V,$ $V_{DS} = 15V,$ $f = 1.0\text{MHz}$	--	5497	--	pF
Output Capacitance	C_{oss}		--	940	--	
Reverse Transfer Capacitance	C_{rss}		--	899	--	
Total Gate Charge	Q_g	$V_{DD} = 15V,$ $I_D = 50A,$ $V_{GS} = 10V$	--	110	--	nC
Gate-Source Charge	Q_{gs}		--	14	--	
Gate-Drain Charge	Q_{gd}		--	26	--	
Turn-on Delay Time	$t_{d(on)}$	$V_{DD} = 15V,$ $I_D = 50A,$ $R_G = 2.5\Omega$	--	24	--	ns
Turn-on Rise Time	t_r		--	23	--	
Turn-off Delay Time	$t_{d(off)}$		--	87	--	
Turn-off Fall Time	t_f		--	37	--	
Drain-Source Body Diode Characteristics						
Continuous Body Diode Current	I_S	$T_C = 25^\circ\text{C}$	--	--	140	A
Body Diode Voltage	V_{SD}	$T_J = 25^\circ\text{C}, I_{SD} = 50A, V_{GS} = 0V$	--	--	1.2	V
Reverse Recovery Charge	Q_{rr}	$I_F = 50A, V_{GS} = 0V$ $di/dt=100A/us$	--	114	--	nC
Reverse Recovery Time	T_{rr}		--	57	--	ns

Notes

1. Repetitive Rating: Pulse width limited by maximum junction temperature
2. EAS condition : $T_J=25^\circ\text{C}, V_{DD}=50V, V_{GS}=10V, L=0.5\text{mH}, R_G=25\Omega$

The table shows the minimum avalanche energy, which is 1089mJ when the device is tested until failure

3. Identical low side and high side switch with identical R_G

Gate Charge Test Circuit

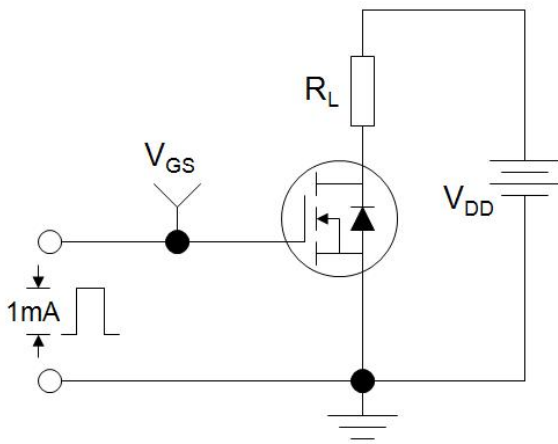

Switch Time Test Circuit



EAS Test Circuit



Typical Characteristics $T_J = 25^\circ\text{C}$, unless otherwise noted

Figure 1. Output Characteristics

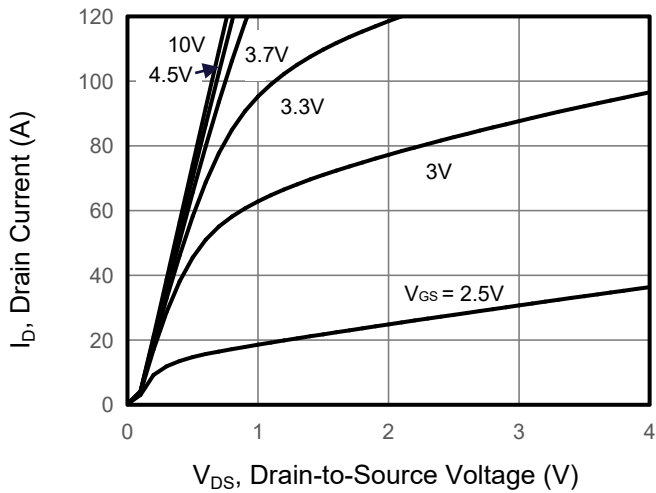

Figure 2. Transfer Characteristics

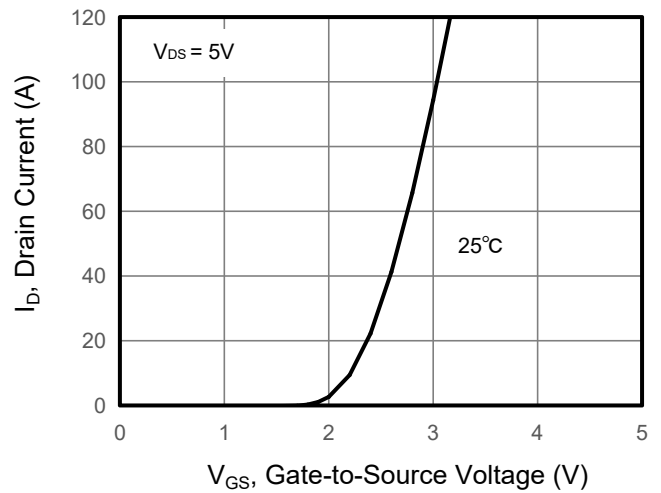

Figure 3. Drain Source On Resistance

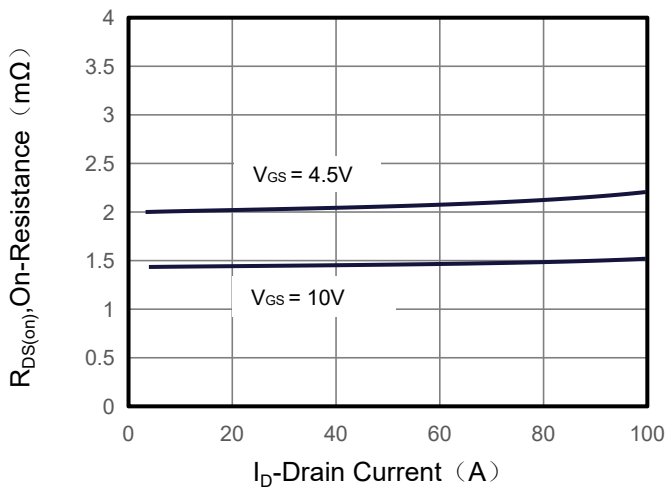

Figure 4. Gate Charge

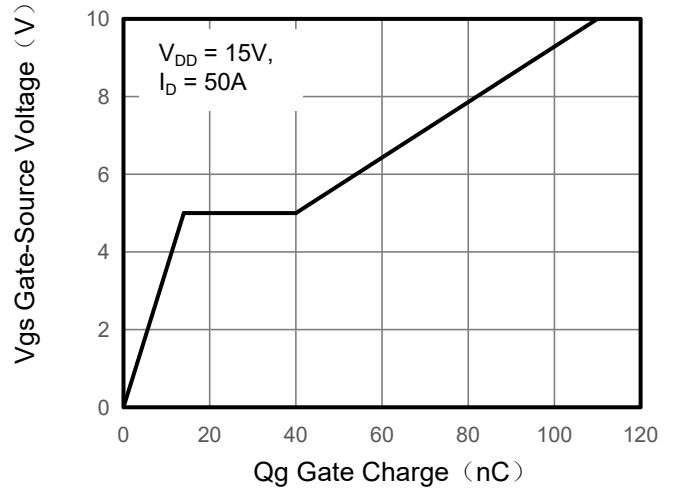

Figure 5. Capacitance

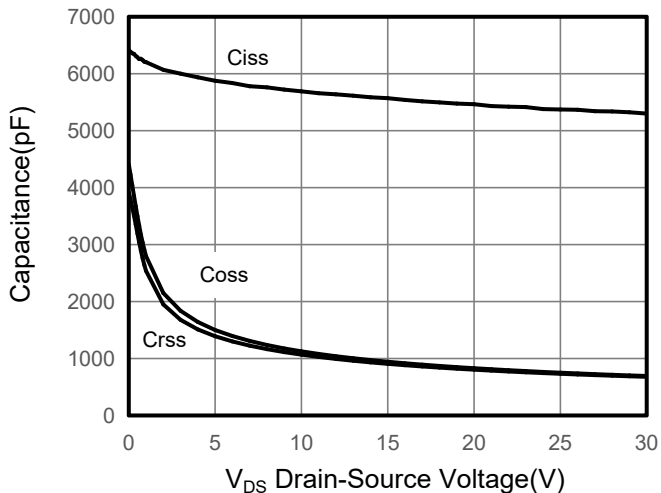
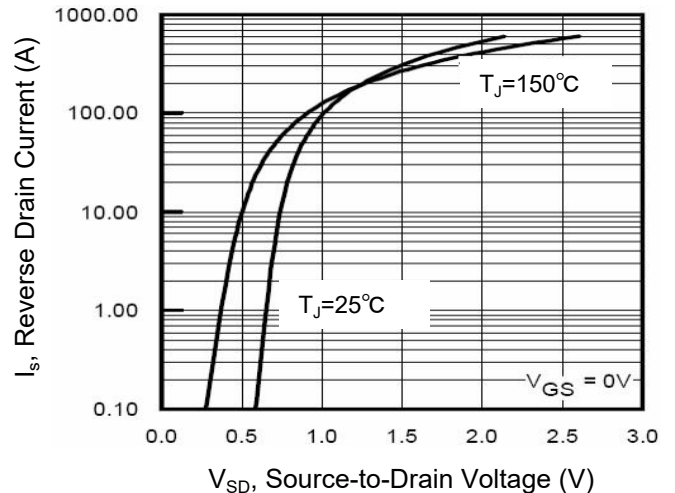

Figure 6. Source-Drain Diode Forward



Typical Characteristics $T_J = 25^\circ\text{C}$, unless otherwise noted

Figure 7. Drain-Source On-Resistance

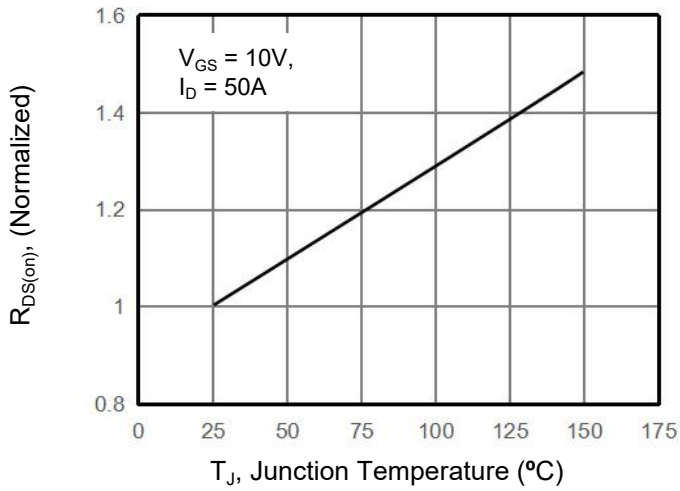

Figure 8. Safe Operation Area

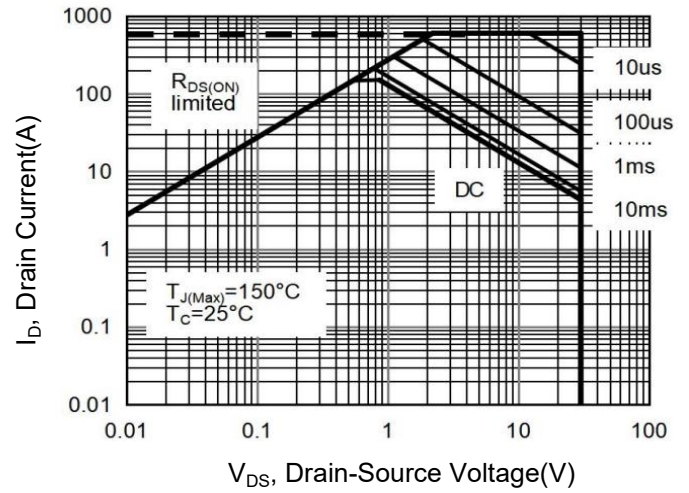
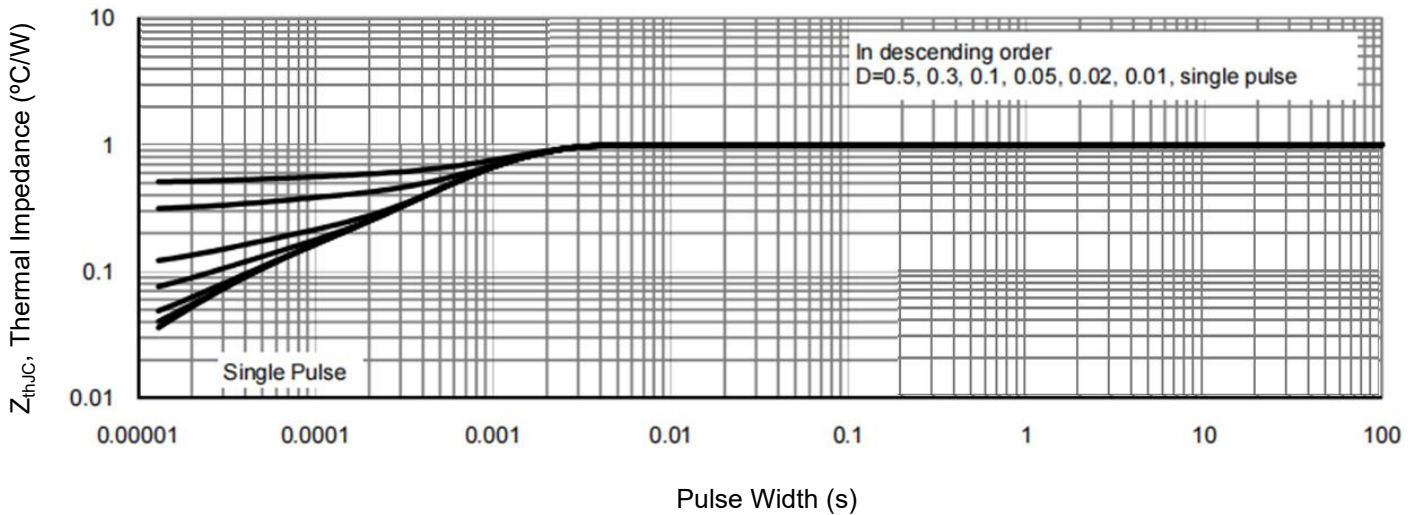
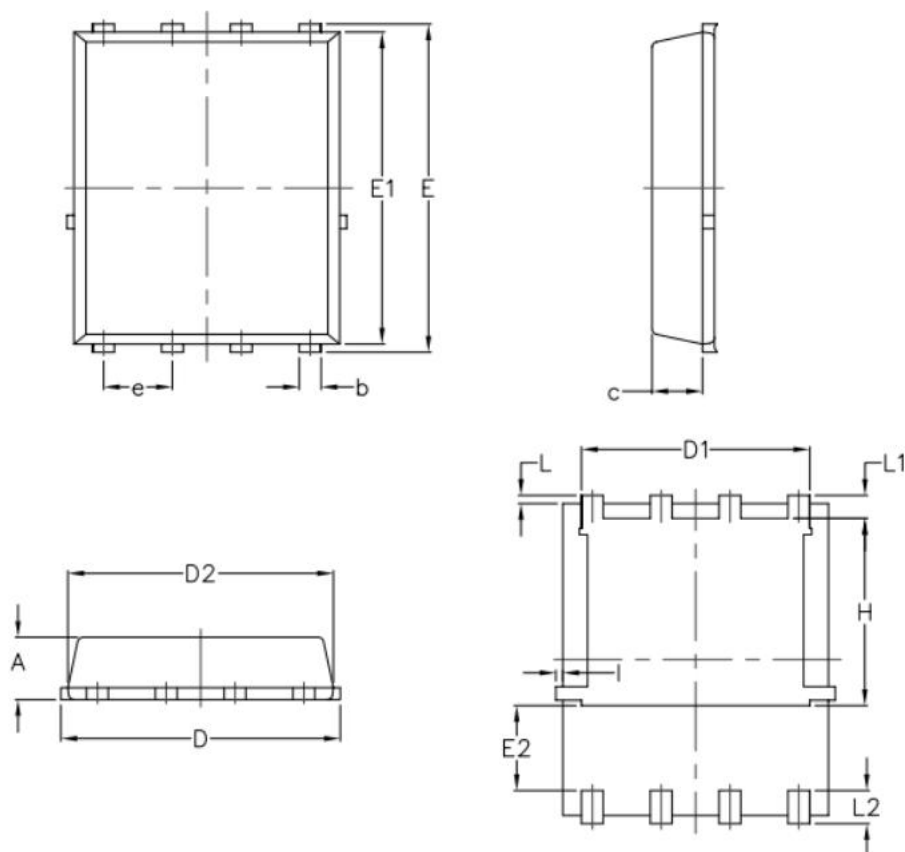

Figure 9. Normalized Maximum Transient Thermal Impedance



DFN5X6-8L Package Information



SYMBOL	COMMON			
	MM		INCH	
	MIN.	MAX.	MIN.	MAX.
A	1.03	1.17	0.0406	0.0461
b	0.34	0.48	0.0134	0.0189
c	0.824	0.970	0.0324	0.0382
△ D	4.80	5.40	0.1890	0.2126
△ D1	4.11	4.31	0.1618	0.1697
△ D2	4.80	5.00	0.1890	0.1969
E	5.95	6.15	0.2343	0.2421
E1	5.65	5.85	0.2224	0.2303
△ E2	1.40	—	0.0551	—
e	1.27 BSC		0.05 BSC	
△ L	0.05	0.25	0.0020	0.0098
L1	0.38	0.50	0.0150	0.0197
△ L2	0.38	0.71	0.0150	0.0280
△ H	3.30	3.50	0.1299	0.1378
I	—	0.18	—	0.0070