

功率型NTC熱敏電阻規格書

APPROVAL SPECIFICATIONS FOR POWER NTC THERMISTORS

客戶 CUSTOMER	立創		
客戶料號 CUSTOMER P/N			
客戶規格描述 CUST. SPEC			
規格描述 DESCRIPTION	8Ω/D7/F5.08/內彎/L3.5(8D-7)		
產品編碼 PART NUMBER	MZ08007C44A00		
日期 DATE	2023/12/9	文件編號 DOC. NO.	DEC-SA-WI008

德爾創承認欄 APPROVED BY DERSONIC		客戶承認欄 APPROVED BY CUSTOMER		
批准 APPROVED BY	審核 CHECK BY	制訂 FORMULATE BY	批准 APPROVED BY	審核 CHECK BY
彭少雄		胡明康		

東莞市德爾創電子有限公司

DONGGUAN CITY DERSONIC ELECTRONICS CO., LTD.

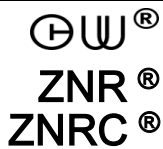

東莞市寮步鎮松湖智谷產業園F2棟15樓
15/F, Blk F2, Songshan Lake Intelligent Valley Industrial Park, Liaobu Town, Dongguan City, PRC
TEL: +86-769-8155 5686 FAX: +86-769-8155 5989
E-mail: sales@dersonic.com / quality@dersonic.com
Website: http://www.dersonic.com

1. 規格表

DATA SHEET

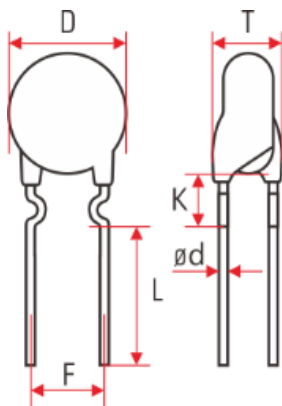

標誌 Marking	NTC 8D-7
---------------	-------------

包封材料 Coating	酚醛樹脂 Phenolic resin
包封顏色 Coating color	黑色 Black
腳型 Lead style	內彎 Inside kink Lead
引線材質 Lead material	CP線 Tin-coated copper-clad steel wire

- Comply with RoHS 2.0
- Halogen-free
- Comply with REACH

產品編碼 Part number	MZ08007C44A00	
規格描述 Description	8Ω/D7/F5.08/內彎/L3.5(8D-7)	
客戶料號 Customer P/N		
零功率電阻 (R25) Zero-Power Resistance (R25)	8Ω ± 20%	
最大穩態電流 Maximum Current at 25°C (Imax)	1A	
B值 B-Value	2800K ± 10%	
散逸因素 (δ) Dissipation Factor (δ)	> 9mW/°C	
熱時常數 (τ) Thermal Time Constant (τ)	< 30s	
Imax下殘余電阻 Residual Resistance at Imax	0.7353Ω	
240VAC下最大允許使用電容值 Recommend Capacitance @ 240Vac	100μF	
工作溫度範圍 Operating Temperature Range	-40°C ~ +150°C	
尺寸規格 Dimensions	D	9mm max
	T	5mm max
	F	5.08mm ± 1.0mm
	L	3.5mm ± 0.5mm
	ød	0.55mm ± 0.1mm
	K	5mm ± 1.5mm

注：
在電源應用中，開機浪湧是電容充電產生的，所以通常用給定電壓值下允許接入的電容值來評估NTC熱敏電阻承受浪湧電流的能力。
功率型NTC熱敏電阻的尺寸確定了其所能承受的最大能量。根據一階電路中電容的能量消耗公式 $E=1/2CV^2$ 可以看出，其允許的接入的電容值與額定電壓的平方成反比。
總而言之，輸入電壓越大，允許接入的最大電容值就越小，反之亦然。

編號DOC NO.:	DEC-SA-WI008
版本REV.:	A/1
日期DATE:	2023/12/9
頁碼PAGE:	2 / 8

2. 簡介

Introduction

負溫度系數熱敏電阻器是一種電阻值隨着溫度的升高而減小的熱敏電阻器。其阻值的變化可以由外在的環境溫度或是回路中電流引起的組件自熱引起。這種電阻值隨着溫度改變的可預知性是熱敏電阻器應用的基礎。

NTC (Negative Temperature Coefficient) thermistors are resistors with large negative temperature coefficient. Change in resistance of the NTC thermistors can be brought about either externally by a change in ambient temperature or internally by self-heating resulting from a current flowing through the device. This predictable change in resistance as temperature changes is the basis for all applications of thermistors.

負溫度系數熱敏電阻器屬於半導體的一種，通常是由錳、鈷、鎳、銅、鐵等組成的過渡金屬氧化物通過燒結後形成不同的形狀和尺寸。通過改變半導體中元素的組成和本體尺寸，室溫中產品的阻值範圍可以從 1Ω 到 $10^6\Omega$ ，溫度系數從 $-2\%/^{\circ}\text{C}$ 到 $-6.5\%/^{\circ}\text{C}$ 。

The semiconducting material of NTC thermistors usually consists of a sintered ceramic fabricated in a variety of shapes and sizes from a mixture of oxides chosen from Mn, Co, Ni, Cu, Fe and etc. . . . By varying the composition and the size of the semi-conducting elements, resistance values between 100 and 10^6 ohms at room temperature can be achieved with temperature coefficients lying between -2% to -6.5% per $^{\circ}\text{C}$.

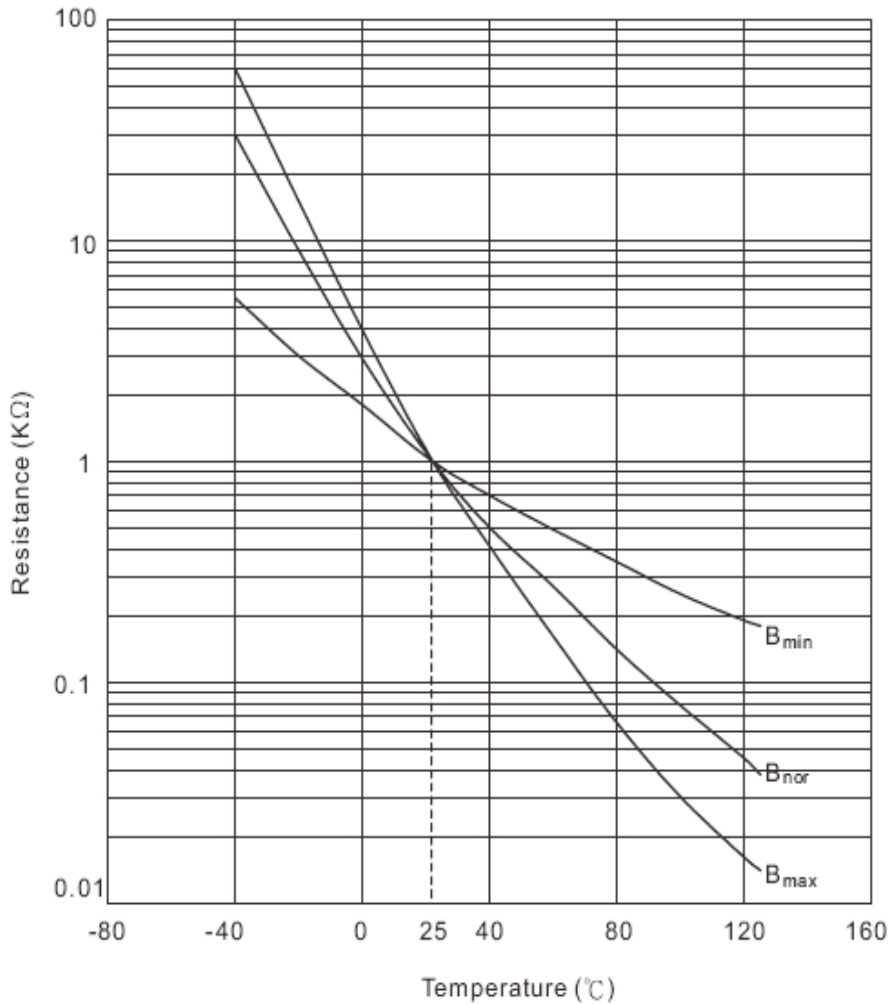

編號DOC NO.:	DEC-SA-WI008
版本REV.:	A/1
日期DATE:	2023/12/9
頁碼PAGE:	3 / 8

3. 應用說明

Application Notes

3.1. 浪湧電流抑制

Surge Current Suppressing

在包含有電容，電燈泡燈絲，熒光燈換流器和加熱器等的電子電路中，在開關閉合的瞬間會產生一個比正常工作電流高出百倍的浪湧電流，利用NTC熱敏電阻器的零功率電阻值來抑制開機瞬間的浪湧電流可以使開機瞬間的浪湧電流不致過大，並且在完成抑制浪湧電流作用以後，由於熱敏電阻的自熱效應，熱敏電阻器本體溫度升高，其電阻值將下降到非常小的程度，不會影響工作電流而使線路的正常工作。

If circuits consist of capacitor, bulb filament, heater, or inverter for fluorescent lamp, they will produce a surge current (10~100 times greater than a normal operating current) at the moment of switch's turn-on. Zero-power resistance of NTC thermistor limits the surge current during initial turn-on, and then heats up the thermistor following continuous flow of current. The thermistor's resistance is reduced to a very low level and allows operating current to flow during normal operation.

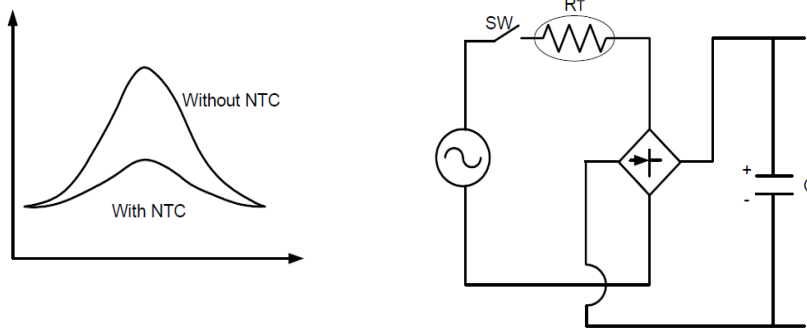

3.2. LED過熱保護

Protecting LEDs from Thermal Stress

散熱控制對高亮度LED控制十分重要。NTC熱敏電阻可提供LED溫度控制一個簡單的解決方案，應用在LED控制電路，偵測過溫時降低驅動電流，保護LED過熱損壞。

Thermal control is a very important aspect of high brightness LED control. NTC thermistor, a simple solution of LED temperature control, is used in LED control circuit to reduce the current as temperature increases. It is possible that current rises following the increase of temperature to protect LEDs from overheating.

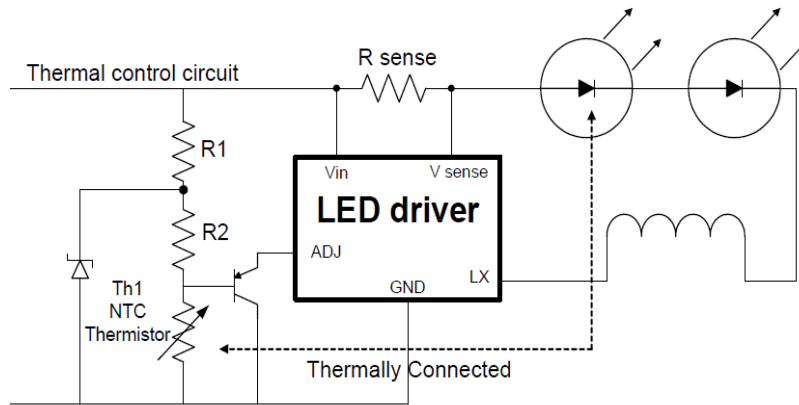

4. 術語

Terms and definitions

- 1) 熱敏電阻器是一種電阻值對溫度極為敏感的半導體元件，其主要特性是電阻值會隨着溫度的變化而變化。

A thermistor is a thermally sensitive semiconductor resistor, and its resistance changes following the change of temperature.

- 2) 負溫度系數(NTC)熱敏電阻器是一種電阻值隨着溫度的升高而減小的熱敏電阻器。

Negative temperature coefficient (NTC) thermistor is a resistor whose resistance decreases following the increase of temperature.

- 3) 零功率電阻是在一定的溫度條件下，電阻器因測量時產生的熱量使得電阻器電阻值的變化小於0.1%時，此電阻值稱為零功率電阻。

The zero-power resistance is the resistance value measured under specified temperature conditions, and the self-heating during measurement can be negligible or the change of resistance caused by self-heating during measurement is less than 0.1%.

- 4) 最大額定功耗是在熱敏電阻在25°C的環境溫度下長時間可施加的最大功率。

The maximum rated power dissipation is the maximum power rating applied to the thermistor continuously at 25°C.

下圖所示在環境溫度超過25°C或低於0°C時需做減額，曲線在TL和TU將線性減額到0%。

Please refer to derating curve below when the ambient temperature is over 25°C or below 0°C. The curve is derated linearly to 0% at TL and TU.

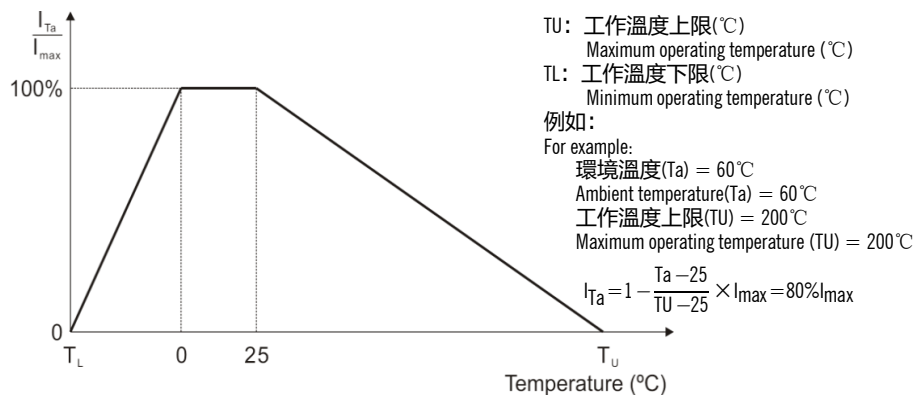

- 5) 電阻-溫度特性是熱敏電阻器零功率電阻與本體溫度之間的關係。

R-T characteristic is the relationship between zero-power resistance and body temperature of a thermistor.

其阻值計算公式如下:

The resistance law follows approximately the formula below:

$$R = R_1 e^{B \left(\frac{1}{T} - \frac{1}{T_1} \right)}$$

在這裏，R和R1分別是在環境溫度T和T1的條件下測得的零功率電阻值，其中溫度用絕對溫度(Kelvin)，B值是熱敏感指數。

R and R1 are the values of a thermistor's zero-power resistance measured at temperature T and T1 respectively. The temperatures are expressed in absolute temperature (in Kelvins), and B is the thermal sensitivity index.

- 6) 電壓-電流特性是指在25°C靜止空氣中，通過熱敏電阻器兩端的穩態電流與跨接的電壓(直流或交流)之間的關係。

V-I characteristic is the relationship between dc or ac voltages across the thermistor and the applied steady-state current under 25°C still air.

5. 型號命名方式

How to order

MZ 080 07 C 4 4 A00
 ① ② ③ ④ ⑤ ⑥ ⑦

序 NO.	特征碼名稱 FEATURE CODE	表達內容 EXPRESSION
①	產品類別 PROSUCT TYPE	MZ: 功率型NTC熱敏電阻(POWER NTC THERMISTORS)
②	零功率電阻 ZERO POWER RESISTANCE	080: 8Ω
③	標稱直徑 NOMINAL DIAMETER	07: 7mm
④	腳距(LEAD SPACING)	C: 5.08mm
⑤	腳型(LEAD STYLE)	4: 內彎(Inside kink Lead)
⑥	腳長(LEAD LENGTH)	4: 3.5mm
⑦	標誌 Marking	A00: 中性标志(Non-trademark mark), 具体见数据表(See Data Sheet)

6. 特點

Features

- 小體積、大功率，抑制浪湧電流能力強
Small size, large power and strong capability of surge current suppression
- 反應速度快
Fast response to surge current
- 材料常數 (B 值) 大，殘余電阻小
Large material constant (B value), small residual resistance
- 壽命長，可靠性高
Longevity of service, high reliability
- 系列全，應用範圍寬
Integral series, wide range of applications

7. 應用範圍

Scope of applications

- 轉換電源，開關電源，適配器，UPS電源
Conversion power supply, switch power, Adapter, UPS power
- 電子節能燈，LED 驅動電路，鎮流器及各類加熱器
Electronic energy saving lamps, LED driver circuit, electronic ballast and all kinds of electric heater
- 電子馬達，變壓器
Electric motor, transformer
- 各類顯像管、顯示器
All kinks of CRT, displayer
- 鹵素燈和其它照明燈具
Halogen lamp and other lighting lamps

6. 測量和試驗

MEASUREMENT AND TEST

No.	項目 Item	標準 Specifications	試驗方法 Testing Method																
1	工作溫度範圍 Operating temperature range	-40°C ~ +150°C	工作溫度範圍是熱敏電阻器能長時間工作在零功率的環境溫度範圍。工作溫度範圍定義最大值和最小值標示在各系列規格表中。 The operating temperature range is ambient temperature range for thermistor's continuous operation at zero-power. Limits of the upper and lower operating temperatures are specified in each series.																
2	零功率電阻 Zero-power resistance (R25)	8Ω ±20%	零功率電阻是指在25°C環境溫度中所測得的電阻值(測試電壓1.5Vdc)。 The zero-power resistance is the nominal value at standard temperature of 25°C (Testing voltage: 1.5Vdc). 注意: 需在常溫條件下, 放置1~2小時。 Note: after placing for 1~2 hours under ambient temperature																
3	最大穩態電流 Maximum current at 25°C (Imax)	無可見損傷 No visible mechanical damage. ΔR25/R25 ≤20%	在25°C溫度下, 使用最大穩態電流進行測試。 At 25°C, the maximum steady state current was used for testing.																
4	熱時常數 Thermal time constant (τ)	<30s	<p>在零功率情況下, 熱敏電阻本體溫度的變化達到其最初溫度與最終溫度差的63.2%時所需的時間。 The thermal time constant is a 63.2% change of thermistor's body temperature from its initial temperature (T0) to specific temperature (T1) under zero power conditions.</p> <p>熱時常數與溫度變化率之間的關係 Thermal time constant and temperature change ratio</p> <table border="1"> <thead> <tr> <th>升溫時間 Temperature rise time</th> <th>τ</th> <th>2τ</th> <th>3τ</th> <th>4τ</th> <th>5τ</th> <th>6τ</th> <th>7τ</th> </tr> </thead> <tbody> <tr> <td>T0-T1溫度變化率(%) Rate of change (%) for T0-T1</td> <td>63.2</td> <td>86.5</td> <td>95</td> <td>98.2</td> <td>99.4</td> <td>99.8</td> <td>99.9</td> </tr> </tbody> </table>	升溫時間 Temperature rise time	τ	2τ	3τ	4τ	5τ	6τ	7τ	T0-T1溫度變化率(%) Rate of change (%) for T0-T1	63.2	86.5	95	98.2	99.4	99.8	99.9
升溫時間 Temperature rise time	τ	2τ	3τ	4τ	5τ	6τ	7τ												
T0-T1溫度變化率(%) Rate of change (%) for T0-T1	63.2	86.5	95	98.2	99.4	99.8	99.9												
5	散逸因素 Dissipation factor (δ)	>9mW/°C	<p>散逸因素是指在特定周圍溫度條件下, 熱敏電阻器消耗功率所造成的本體溫度變化的比值。Dissipation factor is ration of thermistor's temperature change caused by its dissipation power under specific ambient temperature. 可由下列的公式表示 It can be expressed by the formula below,</p> $\delta = V \times I \div (T_2 - T_1)$ <p>單位以mW/°C來表示, 代表熱敏電阻增加1°C所需要的功率 It is expressed in mW/°C which stands for dissipation power for thermistor's increase of 1°C.</p>																
6	B值 B-value	2800K ±10%	<p>B值是指電阻值隨溫度變化的熱敏感指數(代表電阻隨溫度變化曲線的斜率), 可由下面的公式表示: The B-value is an index of thermal sensitivity and represents slope of R/T curves. It can be showed by the formula below,</p> $B = \frac{T_1 \times T_2}{T_2 - T_1} \times \log_e \frac{R_1}{R_2}$ <p>R1/R2: 溫度T1/T2時的電阻值, 單位為Ω Resistance in ohms (Ω) at temperature T1/T2 T1=298.15K (+25°C) T2=358.15K (+85°C) for B25/85</p>																
7	Solderability 可焊性	<p>浸潤部分上錫均勻, 上錫面積 ≥95% The terminals shall be uniformly tinned, and its area ≥95%</p>	<p>將引出端沾助焊劑後, 浸入到溫度為235±5°C、深度為15mm的錫槽中錫面距NTC本體下端6mm處, 持續2-3秒。(參見IEC 60068-2-20 /GB2423.28試驗Ta) Dipping the NTC terminals to a depth of 15mm in a soldering bath of 235±5°C and to the place of 6mm far from NTC body for 2-3s (See IEC 60068-2-20 /GB2423.28 Ta)</p>																

No.	項目 Item	標準 Specifications	試驗方法 Testing Method								
8	耐焊接熱 Resistance to soldering heat	無可見損傷 No visible mechanical damage. $\Delta R_{25}/R_{25} \leq 20\%$	根據IEC 60068-2-20 (GB2423.28) 試驗Tb進行試驗。 採用焊槽法，將引出端沾助焊劑後，浸入到溫度為 $260 \pm 5^\circ\text{C}$ 、深度為15mm的錫槽中，錫面距NTC本體下端6mm處，維持 10 ± 1 秒。在 $25 \pm 2^\circ\text{C}$ 條件下恢復4-5h後，復測零功率電阻R25。 Dipping the NTC terminals to a depth of 15mm in a soldering bath of $260 \pm 5^\circ\text{C}$ and to the place for 6mm below from NTC body for 10 ± 1 s. After recovering 4-5h under $25 \pm 2^\circ\text{C}$. The zero power resistance value R25 shall be measured. (See IEC 60068-2-20 /GB2423.28 Tb)								
9	引出端強度 Strength of lead terminal	無可見損傷 No visible mechanical damage. $\Delta R_{25}/R_{25} \leq 20\%$	根據IEC68-2-21 (GB2423.29) 試驗U進行試驗。 試驗Ua: 拉力10N, 持續10 S; 試驗Ub: 彎曲 90° , 拉力5N, 持續10 S; 扭轉 180° , 拉力5N, 持續10 S。 在 $25 \pm 2^\circ\text{C}$ 條件下恢復4~5 h後，復測零功率電阻R25 Fasten the body and apply a force gradually to each lead until 10N and then keep for 10sec, Hold body and apply a force to each lead until 90° slowly at 5N in the direction of lead axis and then keep for 10sec, and do this in the opposite direction repeat for other terminal. After recovering 4~5h under $25 \pm 2^\circ\text{C}$, the zero power resistance value shall be measured. (See IEC 60068-2-21/GB2423.29 Ua / Ub)								
10	溫度循環測試 Temperature cycling testing	無可見損傷 No visible mechanical damage. $\Delta R_{25}/R_{25} \leq 20\%$	在 $-40 \pm 5^\circ\text{C}$ 和 $150 \pm 5^\circ\text{C}$ 的溫度中各存放30分鐘，循環5次。每次高低溫循環都有在 $25 \pm 2^\circ\text{C}$ 的環境中過渡5分鐘。 The ambient temperature of $-40 \pm 5^\circ\text{C}$ and $150 \pm 5^\circ\text{C}$ is stored for 30 minutes and circulated 5 times. Each high and low temperature cycle has a 5 minute transition in the $25 \pm 2^\circ\text{C}$ environment. 樣品進行溫度循環測試後，取出放置室溫 ($25 \pm 2^\circ\text{C}$) 4~5小時後測量零功率電阻R25。 After recovering 4~5 h under $25 \pm 2^\circ\text{C}$, the rated zero power resistance value R25 shall be measured.								
11	電循環測試 Electrical cycling testing	無可見損傷 No visible mechanical damage. $\Delta R_{25}/R_{25} \leq 20\%$	<table border="1"> <thead> <tr> <th>溫度 Temperature</th> <th>循環次數 Cycles</th> <th>通斷 On / Off</th> <th>測試電流 Test Current</th> </tr> </thead> <tbody> <tr> <td>$25 \pm 2^\circ\text{C}$</td> <td>1000</td> <td>1min / 5min</td> <td>I_{max}</td> </tr> </tbody> </table> 樣品置於室溫 ($25 \pm 2^\circ\text{C}$) 4~5小時後,測量其零功率電阻R25 After recovering 4~5h under $25 \pm 2^\circ\text{C}$, the rated zero power resistance value R25 shall be measured.	溫度 Temperature	循環次數 Cycles	通斷 On / Off	測試電流 Test Current	$25 \pm 2^\circ\text{C}$	1000	1min / 5min	I _{max}
溫度 Temperature	循環次數 Cycles	通斷 On / Off	測試電流 Test Current								
$25 \pm 2^\circ\text{C}$	1000	1min / 5min	I _{max}								
12	持久性測試 Load life testing	無可見損傷 No visible mechanical damage. $\Delta R_{25}/R_{25} \leq 20\%$	在溫度 $25^\circ\text{C} \pm 2^\circ\text{C}$ 下，樣品通過最大穩態電流， $1,000 \pm 24$ 小時後，取出置於室溫 ($25 \pm 2^\circ\text{C}$) 4~5小時後,測量其零功率電阻R25。 Under the ambient temperature $25^\circ\text{C} \pm 2^\circ\text{C}$, the sample passes the maximum steady state current, $1,000 \pm 24$ hours later, takes out at room temperature ($25 \pm 2^\circ\text{C}$) 4-5 hours, measures its zero power resistance value R25.								
13	耐濕性測試 Humidity Testing	無可見損傷 No visible mechanical damage. $\Delta R_{25}/R_{25} \leq 20\%$	在溫度 $40 \pm 2^\circ\text{C}$ ，相對濕度 $93 \pm 3\%$ 的環境中放置 1000 ± 24 小時後，取出置於室溫 ($25 \pm 2^\circ\text{C}$) 4~5小時後,測量其零功率電阻R25。 In the temperature $40 \pm 2^\circ\text{C}$, relative humidity $93 \pm 3\%$ environment placed $1,000 \pm 24$ hours after the removal at room temperature ($25 \pm 2^\circ\text{C}$) 4-5 hours after the measurement of its zero power resistance value R25.								

注意：請不要在下列條件下使用本元件，否則將可能導致產品性能衰退或產品損毀，甚至引發火災：

Notice: Do not apply the components under the following conditions, otherwise, it may result in deterioration of characteristics, destruction of components or in the worst case, to catching fire.

■ 超過最大工作電流

Exceeding I_{max}.

■ 超過許可工作溫度範圍

Exceeding rated temperature range.

■ 散熱不良 (由於散熱不良，本元件可能因部分過熱而導致破壞)

Inferior thermal dissipation (Due to badly inferior thermal dissipation, some part of the components body will become overheated and then be damaged.)

編號DOC NO.:	DEC-SA-WI008
版本REV.:	A/1
日期DATE:	2023/12/9
頁碼PAGE:	8 / 8

7. 貯存條件

STORAGE ENVIRONMENT

NTC熱敏電阻絕緣包封層不是完美的密封形式，因此，請勿將NTC熱敏電阻存放在腐蝕性氣體中，尤其是存在氯氣、硫氣、酸、堿、鹽等場所，同時應防潮。

The insulating coating of NTC thermistors does not form a perfect seal; therefore, do not use or store NTC thermistors in a corrosive atmosphere, especially where chloride gas, sulfide gas, acid, alkali, salt or the like are present. And avoid exposure to moisture.

NTC熱敏電阻應存放在溫度及相對濕度分別不超出40°C及15~70%範圍的場所。

Store the NTC thermistors where the temperature and relative humidity do not exceed 40 degrees centigrade and 15 to 70%.

請在6個月內使用NTC熱敏電阻。超過6個月，在使用前確認其可焊性。

Use NTC thermistors within 6 months after delivered. for more than 6 months, confirm the solderability before use.

8. 編帶規格

TAPING SPECIFICATIONS

方式一
Method 1

孔距(P0)與元件間距離(P)均為12.7mm
或者，孔距(P0)與元件間距離(P)均為15.0mm
12.7mm by feed hole pitch (P0) and components pitch (P)
or, 15.0mm by feed hole pitch (P0) and components pitch (P)

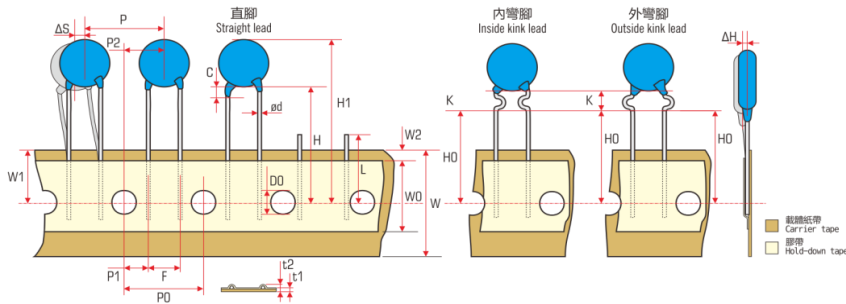

方式二
Method 2

孔距(P0)為12.7mm，元件間距離(P)為24.4mm
Feed hole pitch (P0) with 12.7mm
and components pitch (P) with 25.4mm

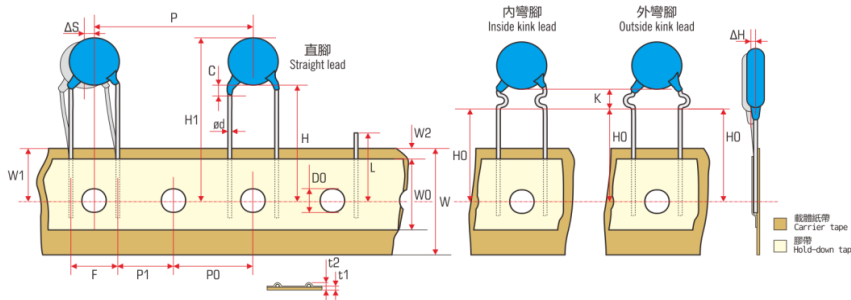

尺寸規格(mm) Dimensions (mm)

項目 Item	符號 Symbol	尺寸 Dimension	公差 Tolerance
導線到元件間距離	F	5.0	±0.8
元件間距離	P	12.7	±1.0
導線孔間距離	P0	12.7	±0.3
導線孔到元件間距離	P1	3.85	±0.7
導線孔到元件間距離	P2	6.35	±1.3

項目 Item	符號 Symbol	標準 Specifications	公差 Tolerance
導線直徑	φd	0.55* 0.75	±0.1
沿膠帶長度方向的偏差	ΔS	1.3	max
沿膠帶長度方向的偏差	Δh	2.0	max
膠帶寬度	W	18.0	+1.0 -0.5
膠帶厚度	W0	7.0	min
膠帶厚度	W1	9.0	+0.75 -0.5
膠帶厚度	W2	3.0	max
膠帶高度	H	18.0	+2.0 -0
膠帶高度	H0	16.0	±0.5
膠帶高度	H1	40.0	max
膠帶直徑	D0	4.0	±0.3
膠帶厚度	t1	0.9	max
膠帶厚度及導線直徑	t2	1.5** 1.7	max
膠帶長度	L	11.0	max
膠帶長度	C	3.0	max
膠帶高度	K	5.0	max

*: 導線直徑，見規格表。
Lead diameter, see "DATA SHEET".
**: 導線直徑為0.55mm時1.5mm最大，導線直徑為0.75mm時1.7mm最大。
1.5mm maximum when the lead diameter is 0.55mm; 1.7mm maximum when the lead diameter is 0.75mm.