

■ PRODUCT CHARACTERISTICS

V_{DS}	60V
$R_{DS(on)}$ typ(@ $V_{GS}=10V$)	22.5m Ω
$R_{DS(on)}$ typ(@ $V_{GS}=4.5V$)	28m Ω
I_D	20A

■ FEATURE

- Low $R_{DS(ON)}$
- Low gate charge
- Pb-free lead plating

■ APPLICATIONS

- Motor driving in power tool
- E-vehicle robotics

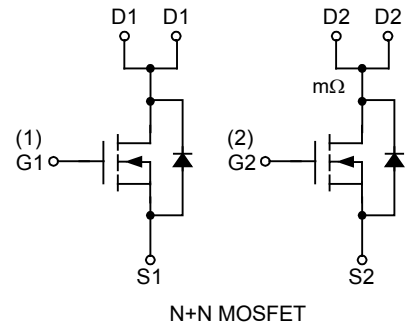
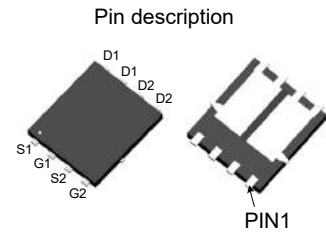

■ ORDER INFORMATION

Order codes		Package	Packing
Halogen-free	Halogen		
N/A	MOT6929J	PDFN3X3-8L	5000Pieces/Reel

■ ABSOLUTE MAXIMUM RATINGS ($T_C = 25^\circ C$, unless otherwise specified)

Parameter	Symbol	Value	units
Drain-Source Voltage	V_{DS}	60	V
Gate-Source Voltage	V_{GS}	± 20	V
Drain Current-Continuous	I_D	$T_C=25^\circ C$	20
		$T_C=100^\circ C$	13
Pulsed Drain Current	I_{DM}	80	A
Avalanche Energy	E_{AS}	13.5	mJ
Maximum Power Dissipation	P_D	$T_C=25^\circ C$	28
		$T_C=100^\circ C$	11.1
Operating Junction and Storage Temperature Range	T_J, T_{STG}	-55 To 150	$^\circ C$

■ THERMAL CHARACTERISTICS

Parameter	Symbol	Value	units
Thermal Resistance, Junction-to-Ambient	$R_{\theta JA}$	70	$^\circ C/W$
Thermal Resistance, Junction-to-Case	$R_{\theta JC}$	5.2	$^\circ C/W$

■ Electrical Characteristics ($T_C=25^\circ\text{C}$ unless otherwise specified)

Parameter	Symbol	Conditions	Min	Typ	Max	Unit
STATIC PARAMETERS						
Drain-Source Breakdown Voltage	$V_{(BR)DSS}$	$I_D = 250\mu\text{A}, V_{GS} = 0\text{V}$	60	-	-	V
Zero Gate Voltage Drain Current	I_{DSS}	$V_{DS} = 48\text{V}, V_{GS} = 0\text{V}$ $T_J = 55^\circ\text{C}$	-	-	1.0	μA
			-	-	5.0	
Gate-Body Leakage Current	I_{GSS}	$V_{DS} = 0\text{V}, V_{GS} = \pm 20\text{V}$	-	-	± 100	nA
Gate Threshold Voltage	$V_{GS(th)}$	$V_{DS} = V_{GS}, I_D = 250\mu\text{A}$	1.2	-	2.5	V
Static Drain-Source ON-Resistance	$R_{DS(on)}$	$V_{GS} = 10\text{V}, I_D = 5\text{A}$	-	22.5	29	$\text{m}\Omega$
		$V_{GS} = 4.5\text{V}, I_D = 3\text{A}$	-	28	38	$\text{m}\Omega$
Forward Transconductance	g_{FS}	$V_{DS} = 5\text{V}, I_D = 5\text{A}$	-	17.0	-	S
Diode Forward Voltage	V_{SD}	$I_S = 1\text{A}, V_{GS} = 0\text{V}$	-	0.75	1.0	V
Diode Continuous Current	I_S	$T_C = 25^\circ\text{C}$	-	-	23	A
DYNAMIC PARAMETERS						
Input Capacitance	C_{iss}	$V_{GS} = 0\text{V}, V_{DS} = 30\text{V}, f = 1\text{MHz}$	-	288	-	pF
Output Capacitance	C_{oss}		-	92	-	pF
Reverse Transfer Capacitance	C_{rss}		-	22	-	pF
Gate Resistance	R_g	$V_{GS} = 0\text{V}, V_{DS} = 0\text{V}, f = 1\text{MHz}$	-	5.0	-	Ω
SWITCHING PARAMETERS						
Total Gate Charge	Q_g	$V_{GS} = 0 \text{ to } 10\text{V}$ $V_{DS} = 30\text{V}, I_D = 5\text{A}$	-	50	-	nC
Gate Source Charge	Q_{gs}		-	6	-	nC
Gate Drain Charge	Q_{gd}		-	15	-	nC
Turn-On DelayTime	$t_{D(on)}$	$V_{GS} = 10\text{V}, V_{DS} = 30\text{V}$ $R_L = 6\Omega, R_{GEN} = 6\Omega$	-	6.0	-	nS
Turn-On Rise Time	t_r		-	62	-	nS
Turn-Off DelayTime	$t_{D(off)}$		-	18.5	-	nS
Turn-Off Fall Time	t_f		-	97	-	nS
Body Diode Reverse Recovery Time	t_{rr}		$I_F = 5\text{A}, dI_F/dt = 100\text{A}/\mu\text{S}$	-	13.0	-
Body Diode Reverse Recovery Charge	Q_{rr}	$I_F = 5\text{A}, dI_F/dt = 100\text{A}/\mu\text{S}$	-	6.0	-	nC

■ TYPICAL CHARACTERISTICS

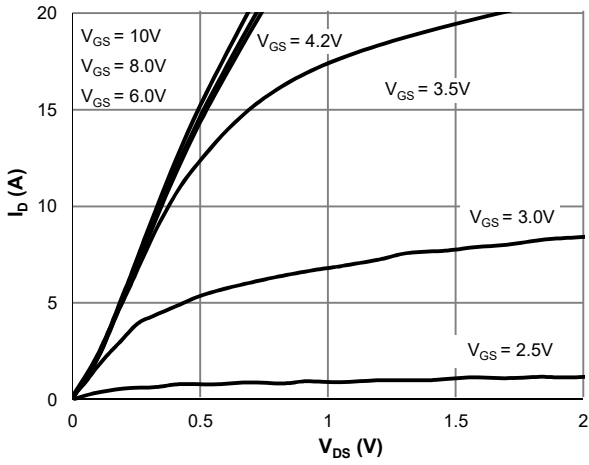

Figure 1: Saturation Characteristics

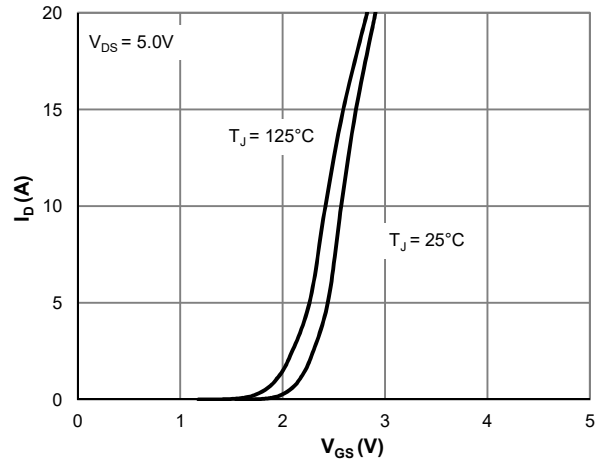

Figure 2: Transfer Characteristics

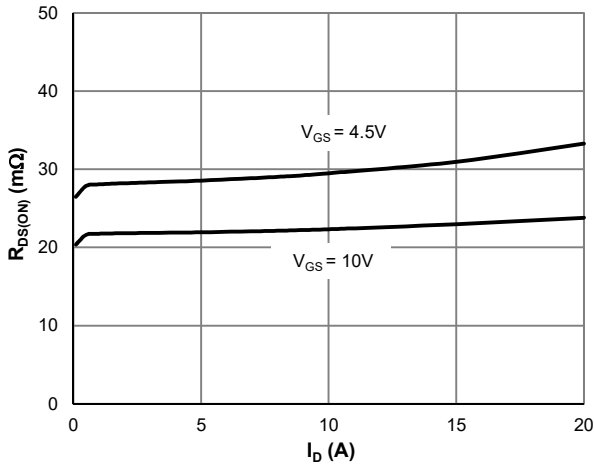

Figure 3: $R_{DS(ON)}$ vs. Drain Current

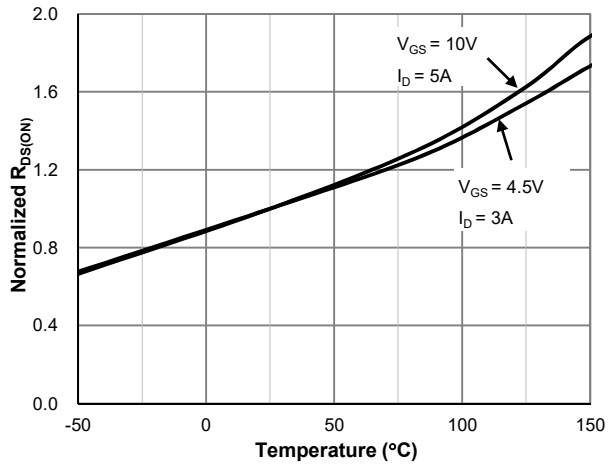

Figure 4: $R_{DS(ON)}$ vs. Junction Temperature

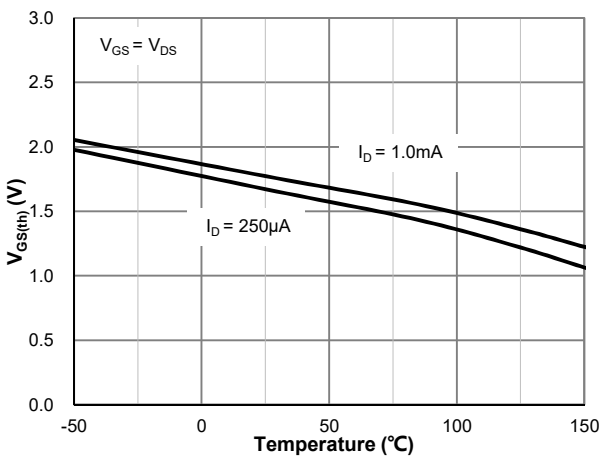

Figure 5: $V_{GS(th)}$ vs. Junction Temperature

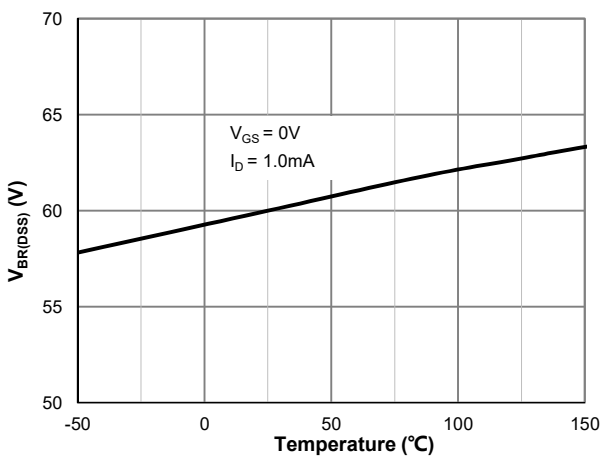

Figure 6: $V_{BR(DSS)}$ vs. Junction Temperature

■ TYPICAL CHARACTERISTICS(Cont.)

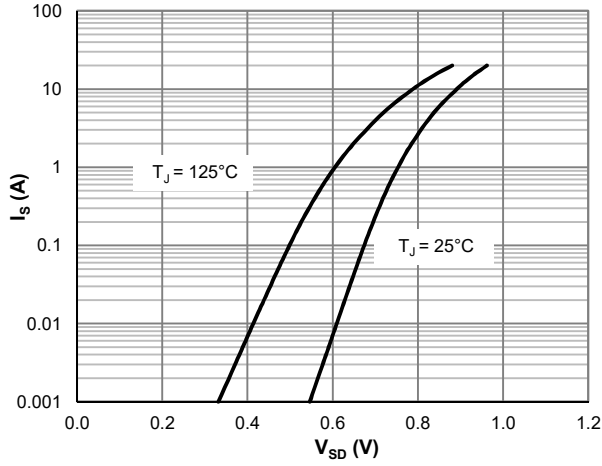

Figure 7: Body-Diode Characteristics

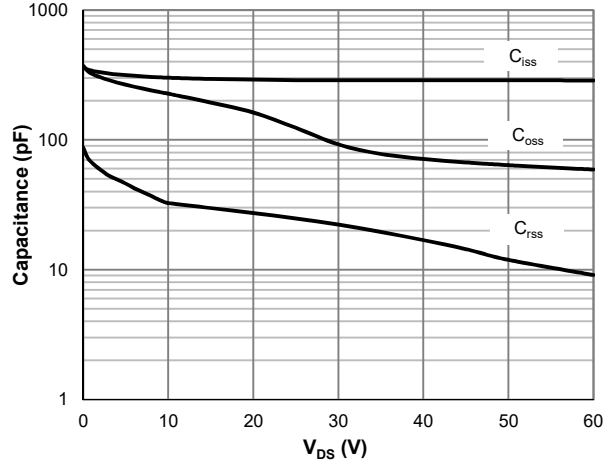

Figure 8: Capacitance Characteristics

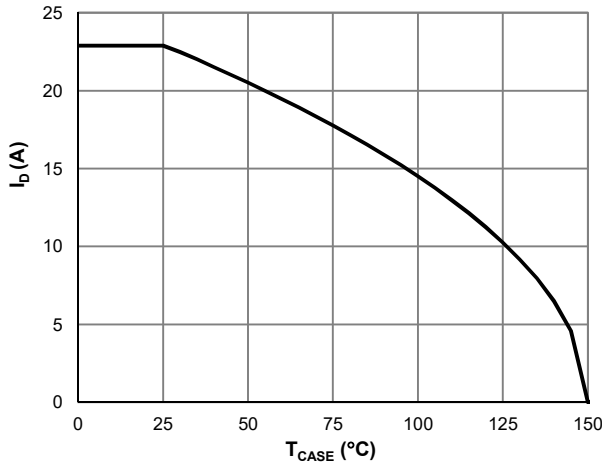

Figure 9: Current De-rating

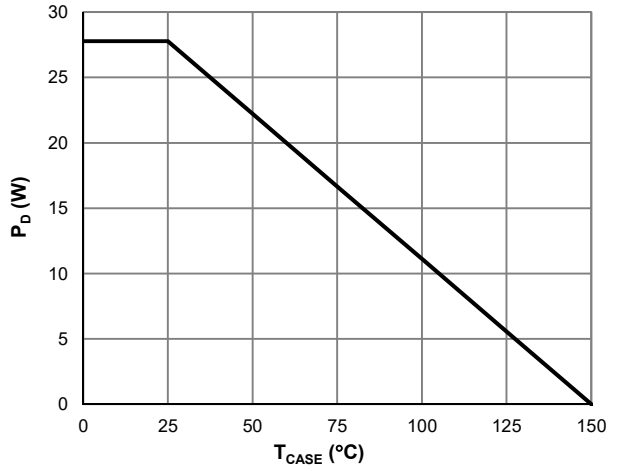

Figure 10: Power De-rating

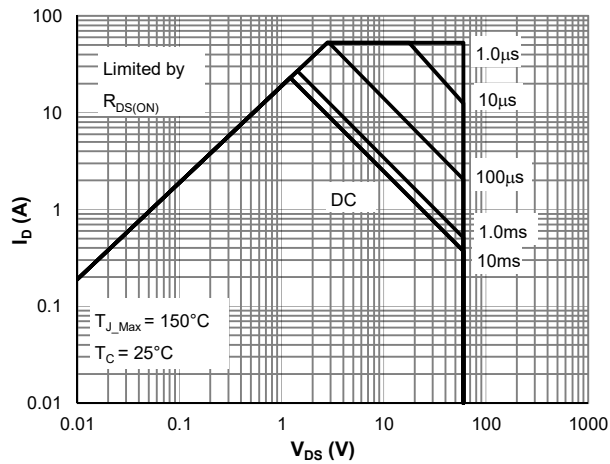

Figure 11: Maximum Safe Operating Area

■ TYPICAL CHARACTERISTICS(Cont.)

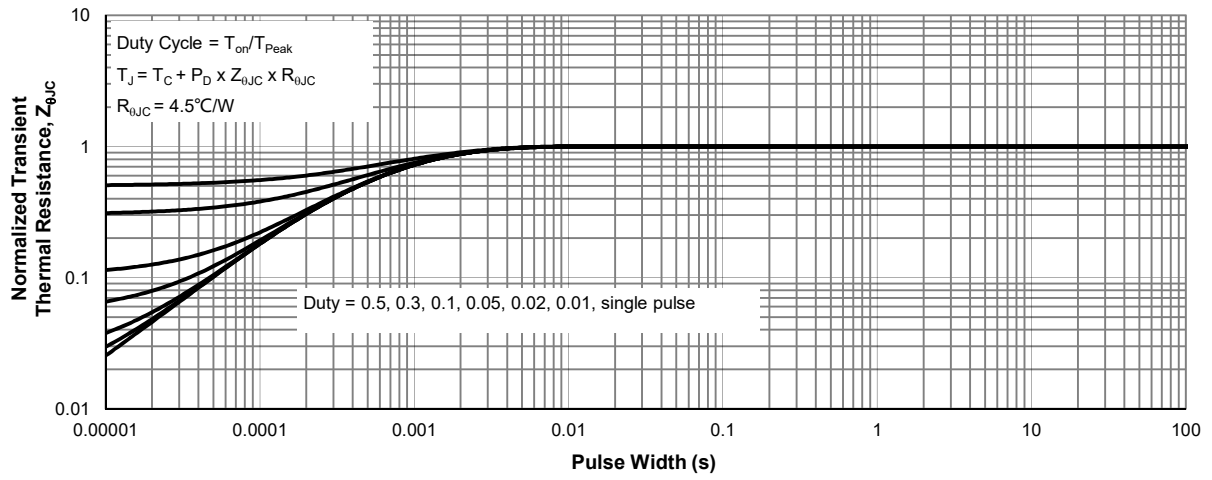
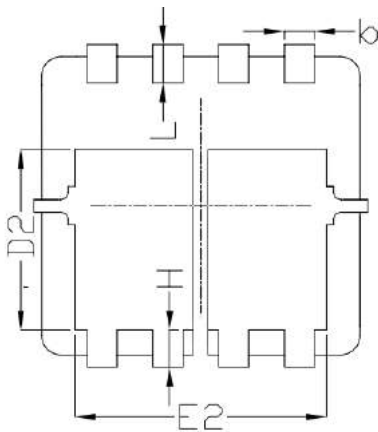
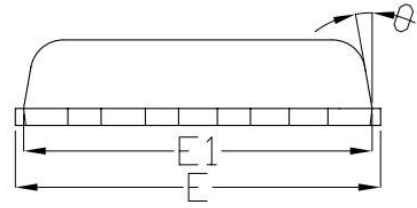
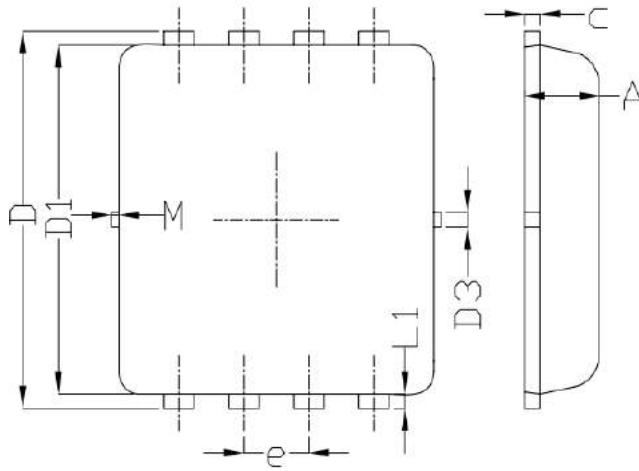

Figure 12: Normalized Maximum Transient Thermal Impedance

■ PDFN3X3-8L Package Mechanical Data



SYMBOL	DIMENSIONAL REQMTS		
	MIN	NOM	MAX
A	0.70	0.75	0.80
b	0.25	0.30	0.35
c	0.10	0.15	0.25
D	3.25	3.35	3.45
D1	3.00	3.10	3.20
D2	1.78	1.88	1.98
D3	---	0.13	---
E	3.20	3.30	3.40
E1	3.00	3.15	3.20
E2	2.39	2.49	2.59
e	0.65BSC		
H	0.30	0.39	0.50
L	0.30	0.40	0.50
L1	---	0.13	---
θ	---	10°	12°
M	*	*	0.15
* Not specified			