

修订 REV	标记 MARK	修改摘要 REVISION DESCRIPTION	签名 SIGNATURE	日期 DATE
AO		NEW RELEASE	黄艳兰	2020-12-22

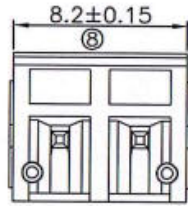

381公头

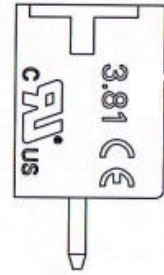
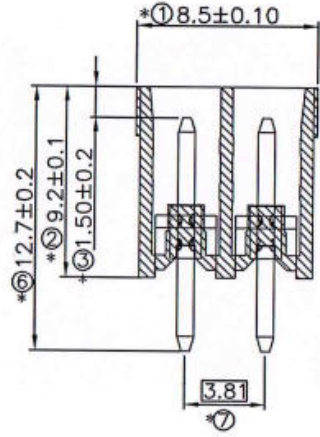
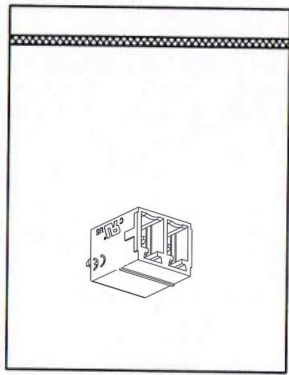

包装示意图

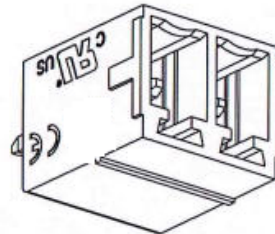

产品详细说明:

一. 材质

1. 绝缘体材质: PA66 无卤94V-0 绿色
2. 端子 材质: 黄铜

二. 电镀

1. 端子电镀:
镍底: 20-50u"; 镀锡: 80u"MIN 盐雾: 不测盐雾。

三. 电气性能

1. 额定电压/流: 250V/8A
2. 耐 电压: AC 1500V 0.5mA
3. 绝缘阻抗: DC500V ≥100MΩ
4. 接触阻抗: 10mΩ MAX
5. 工作温度: -40℃~+125℃

四. 机械性能

1. 插入力: 不大于30N
2. 拔出力: 不小于3N
3. 插拔寿命200次以上.
4. PIN针与胶壳保持力不小于3KG.

五. 尺寸管控

1. 标有"⊗"为QC首件检验尺寸.
2. 标有"*"为QC巡检检验尺寸.

六. 包装方式

PE袋包装, 1000PCS/袋 14袋/箱

 深圳市华德共创科技有限公司 Shenzhen Huade co-create Technology Co.,LTD TEL : 0755-27129737 FAX : 0755-29940187				TITLE: 产品名称: 3.81端子台直插公头					
-TOLERANCES- UNLESS OTHERWISE SPECIFIED 公差参数表						PART NO: 产品编号: HDGC381-F-XP			
X.X	±0.30	X.X°	±3°	APPD: 核准:	谢亮	DATE	SCALE	UNIT	CODE NUMBER
X.XX	±0.30	X.XX°	±2°	CHECK: 校对:	王建业	2020-12-22	1:1	mm	A153
X.XXX	±0.10	X.XXX°	±1°	DRAW: 绘图:	黄艳兰				

修订 REV	标记 MARK	修改摘要 REVISION DESCRIPTION	签名 SIGNATURE	日期 DATE
AO		NEW RELEASE	黄艳兰	2020-12-22

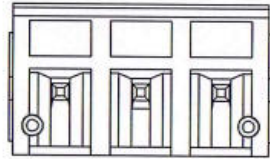
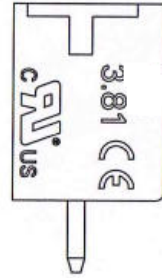
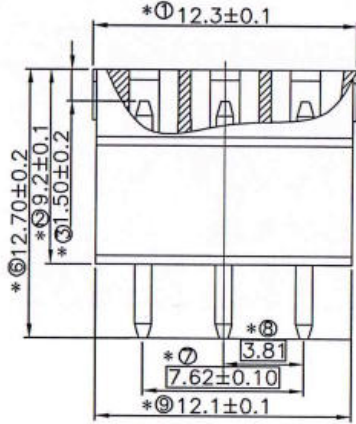
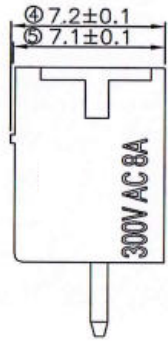

381公头

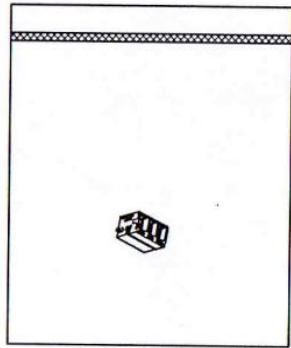

包装示意图

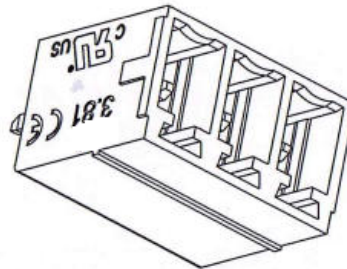

产品详细说明:

一. 材质

1. 绝缘体材质: PA66 无卤94V-0 绿色
2. 端子 材质: 黄铜 (C2680)

二. 电镀

1. 端子电镀:
镍底: 20-50u"; 镀锡: 80u"MIN 盐雾: 不测盐雾。

三. 电气性能

1. 额定电压/流: 250V/8A
2. 耐 电压: AC 1500V 0.5mA
3. 绝缘阻抗: DC500V ≥100MΩ
4. 接触阻抗: 10mΩ MAX
5. 工作温度: -40℃~+125℃

四. 机械性能

1. 插入力: 不大于30N
2. 拔出力: 不小于3N
3. 插拔寿命200次以上.
4. PIN针与胶壳保持力不小于3KG.

五. 尺寸管控

1. 标有"⊗"为QC首件检验尺寸.
2. 标有"*"为QC巡检检验尺寸.

六. 包装方式

PE袋包装, 1000PCS/袋 14袋/箱



深圳市华德共创科技有限公司

Shenzhen Huade co-create Technology Co.,LTD

TEL : 0755-27129737 FAX : 0755-29940187

-TOLERANCES- UNLESS OTHERWISE SPECIFIED 公差参数表				 		TITLE: 产品名称: 381-3P公座			
X.X	±0.30	X.X°	±3°	APPD: 核准:	谢亮	PART NO: 产品编号:			
X.XX	±0.30	X.XX°	±2°	CHECK: 校对:	王建业	DATE	SCALE	UNIT	CODE NUMBER
X.XXX	±0.10	X.XXX°	±1°	DRAW: 绘图:	黄艳兰	2020-12-22	1:1	mm	A153

修订 REV	标记 MARK	修改摘要 REVISION DESCRIPTION	签名 SIGNATURE	日期 DATE
AO		NEW RELEASE	黄艳兰	2020-12-22

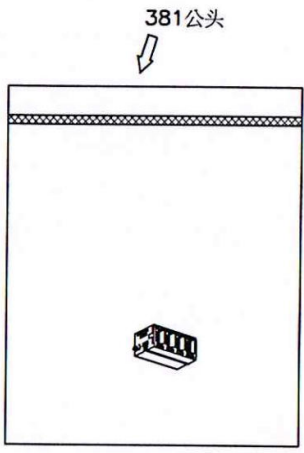
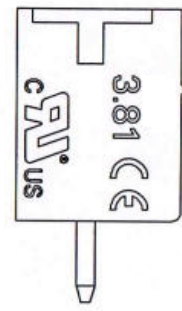
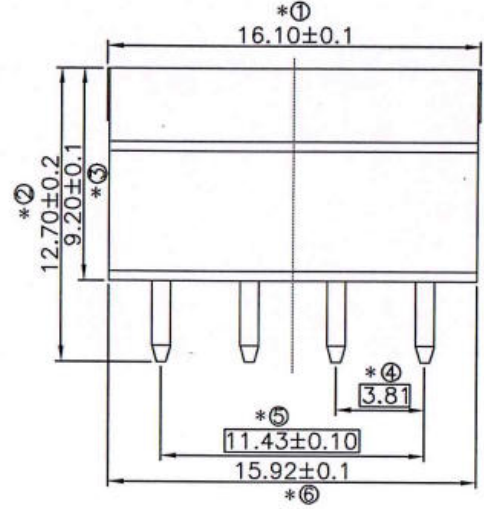
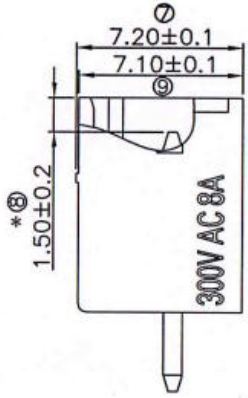

包装示意图

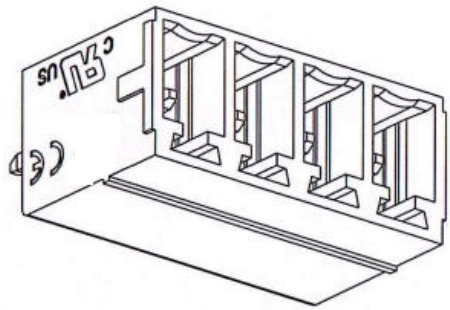

产品详细说明:

一. 材质

1. 绝缘体材质: PA66 无卤94V-0 绿色
2. 端子 材质: 黄铜 (C2680)

二. 电镀

1. 端子电镀:
镍底: 20-50u"; 镀锡: 80u"MIN 盐雾: 不测盐雾。

三. 电气性能

1. 额定电压/流: 250V/8A
2. 耐 电压: AC 1500V 0.5mA
3. 绝缘阻抗: DC500V ≥100MΩ
4. 接触阻抗: 10mΩ MAX
5. 工作温度: -40℃ ~ +125℃

四. 机械性能

1. 插入力: 不大于30N
2. 拔出力: 不小于3N
3. 插拔寿命200次以上.
4. PIN针与胶壳保持力不小于3KG.

五. 尺寸管控

1. 标有"⊗"为QC首件检验尺寸.
2. 标有"*"为QC巡检检验尺寸.

六. 包装方式

PE袋包装, 600PCS/袋 20袋/箱

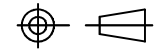
 深圳市华德共创科技有限公司 Shenzhen Huade co-create Technology Co., LTD TEL : 0755-27129737 FAX : 0755-29940187				TITLE: 产品名称: 381-4P公座					
-TOLERANCES- UNLESS OTHERWISE SPECIFIED 公差参数表						PART NO: 产品编号:			
X.X	±0.30	X.X°	±3°	APPD: 核准:	谢亮	DATE	SCALE	UNIT	CODE NUMBER
X.XX	±0.30	X.XX°	±2°	CHECK: 校对:	王建业	2020-12-22	1:1	mm	A153
X.XXX	±0.10	X.XXX°	±1°	DRAW: 绘图:	黄艳兰				

修订 REV	标记 MARK	修改摘要 REVISION DESCRIPTION	签名 SIGNATURE	日期 DATE
AO		NEW RELEASE	黄艳兰	2020-12-22

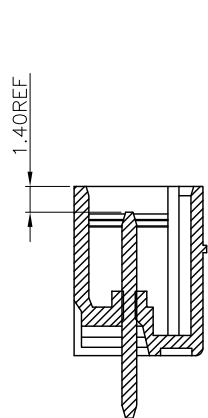

SECTION A-A
SCALE 1:1

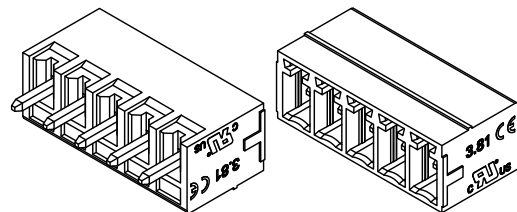
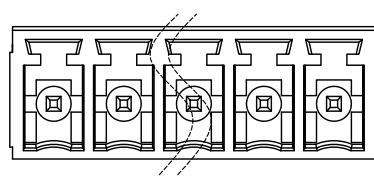
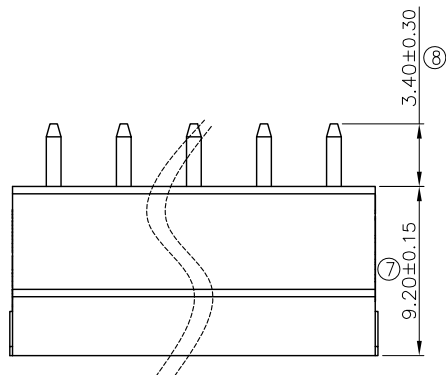

3D辅助视图

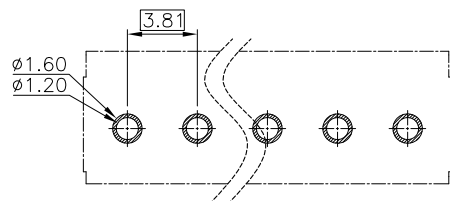
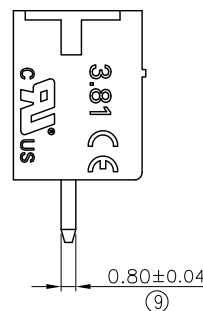
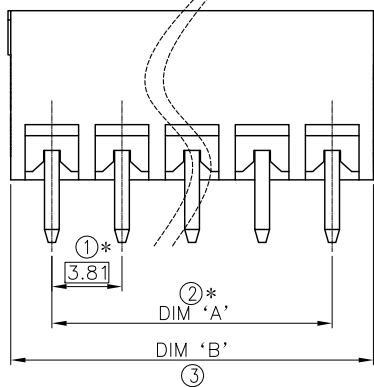
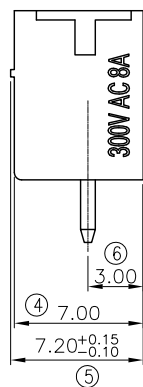

RECOMMENDED P.C.B. LAYOUT
TOLERANCE UNSPECIFIED ±0.05mm

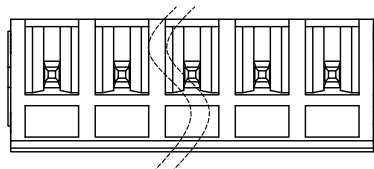

产品详细说明:

一.材质

- 1.端子 材质: 黄铜 (C2680)
- 2.塑胶 材质: PA66 无卤,防火等级:UL 94V-0

二.电镀

- 1.端子电镀: 镍底:20u"MIN; 镀锡:40u"MIN .

三.电气性能

- 1.参考SPEC

四.环境性能

- 1.环境温度 (工作): -40°C ~ +105°C
- 2.环境温度 (存放/运输): -40°C ~ +70°C
- 3.环境温度 (组装): -5°C ~ +70°C

- 4.其他参考SPEC

五.机械性能

- 1.参考SPEC

六.尺寸管控

- 1.标有"⊗"为QC首件检验尺寸.
- 2.标有"*"为QC巡检检验尺寸.



深圳市华德共创科技有限公司

Shenzhen Huade co-create Technology Co.,LTD

TEL : 0755-27129737 FAX : 0755-29940187

-TOLERANCES- UNLESS OTHERWISE SPECIFIED 公差参数表				TITLE: 产品名称: 381-5-8P公座	
X.X	±0.30	X.X°	±3°	APPD: 核准: 谢亮	PART NO: 产品编号:
X.XX	±0.30	X.XX°	±2°	CHECK: 校对: 王建业	DATE
X.XXX	±0.10	X.XXX°	±1°	DRAW: 绘图: 黄艳兰	SCALE
					UNIT
					CODE NUMBER
					A153