

BNPESD3V3U1UA

ESD Protection Diode

Features

- 800Watts peak pulse power ($t_p = 8/20\mu s$)
- Unidirectional configurations
- Solid-state silicon-avalanche technology
- Low clamping Voltage
- Low leakage current
- Protection one data/power line
- IEC 61000-4-2 $\pm 30kV$ contact ; $\pm 30kV$ air
- IEC 61000-4-4 (EFT) 40A (5/50ns)
- IEC 61000-4-5 (Lightning) 40A (8/20 μs)

Package

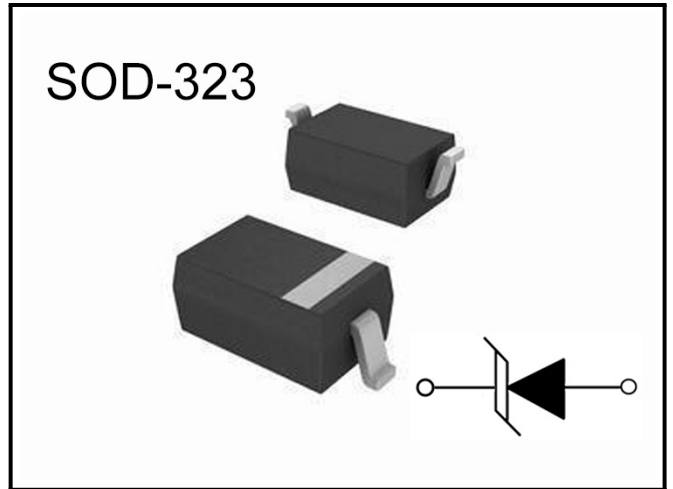

Applications

- USB Vbus
- Power Line
- Power management

Mechanical Characteristics

- SOD323 package
- Molding compound flammability rating: UL 94V-0
- Packaging: Tape and Reel
- RoHS/WEEE Compliant

Marking



Ordering information

Order code	Package	Base qty	Delivery mode
BNPESD3V3U1UA	SOD-323	3k	Tape and reel



Electrical Parameters ($T_A = 25^\circ\text{C}$ unless otherwise noted)

Symbol	Parameter
I_{PP}	Maximum Reverse Peak Pulse Current
V_C	Clamping Voltage @ I_{PP}
V_{RWM}	Peak Reverse Working Voltage
I_R	Reverse Leakage Current @ V_{RWM}
V_{BR}	Breakdown Voltage @ I_T
I_T	Test Current

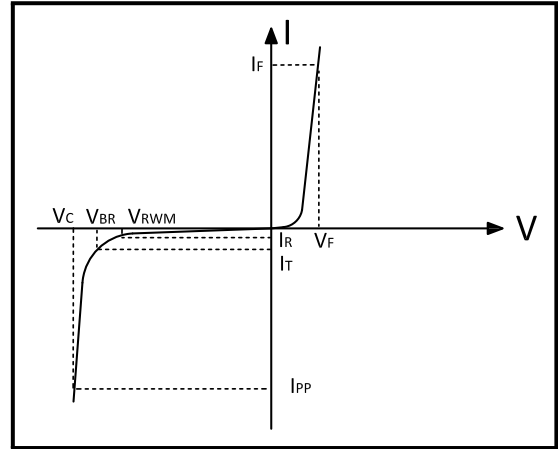

Note: 8/20us pulse Waveform.

Absolute Maximum Rating

Rating	Symer	Value	Units
Peak Pulse Power ($t_p = 8/20\mu\text{s}$)	P_{PP}	800	Watts
Peak Pulse Current ($t_p = 8/20\mu\text{s}$)	I_{PP}	40	A
ESD per IEC 61000-4-2 (Air)	V_{ESD}	30	KV
ESD per IEC 61000-4-2 (Contact)		30	
Lead Soldering Temperature	T_L	260(10seconds)	$^\circ\text{C}$
Junction Temperature	T_J	-55 to + 150	$^\circ\text{C}$
Storage Temperature	T_{stg}	-55 to + 150	$^\circ\text{C}$

Electrical Characteristics

Parameter	Symer	Conditions	Min	Typical	Max	Units
Reverse Stand-Off Voltage	V_{RWM}	-	-	-	3.3	V
Reverse Breakdown Voltage	V_{BR}	$I_T = 1\text{mA}$	4.0	5.3	7.0	V
Reverse Leakage Current	I_R	$V_{RWM} = 3.3\text{V}, T = 25^\circ\text{C}$	-	-	0.2	μA
Clamping Voltage	V_C	$I_{PP} = 40\text{A}, t_p = 8/20\mu\text{s}$	-	18	20	V
Junction Capacitance	C_j	$V_R = 0\text{V}, T = 25^\circ\text{C}, f = 1\text{MHZ}$	-	2.3	3.0	pF





BNPESD3V3U1UA

ESD Protection Diode

Typical Characteristics

Figure 1: Peak Pulse Power vs. Pulse Time

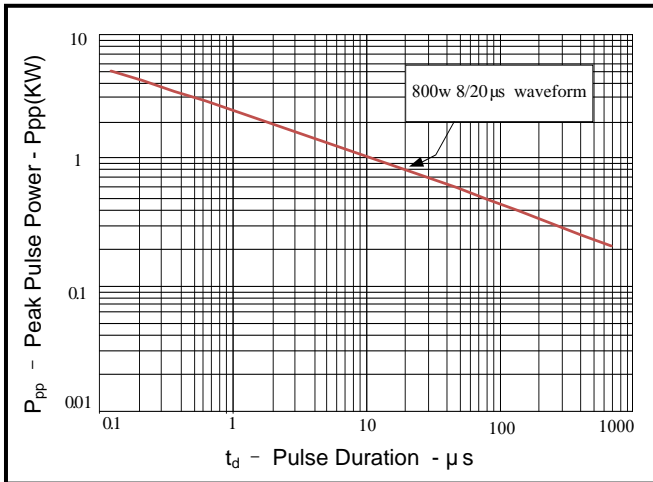

Figure 2: Power Derating Curve

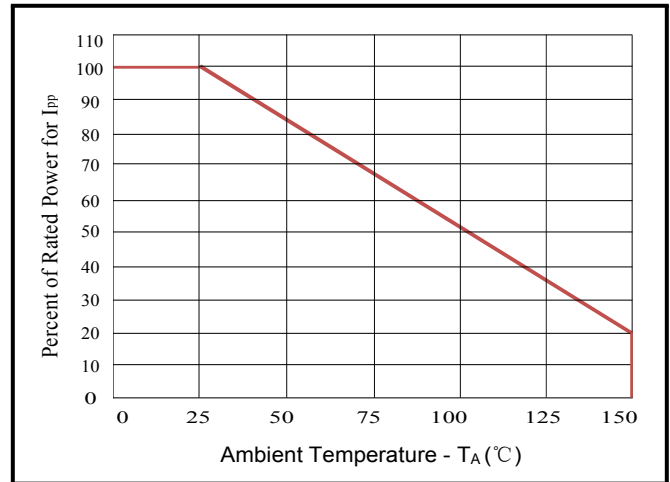

Figure 3: Pulse Waveform

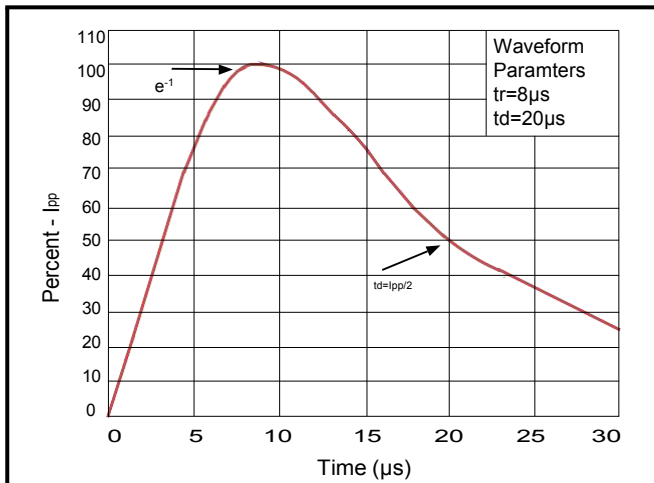
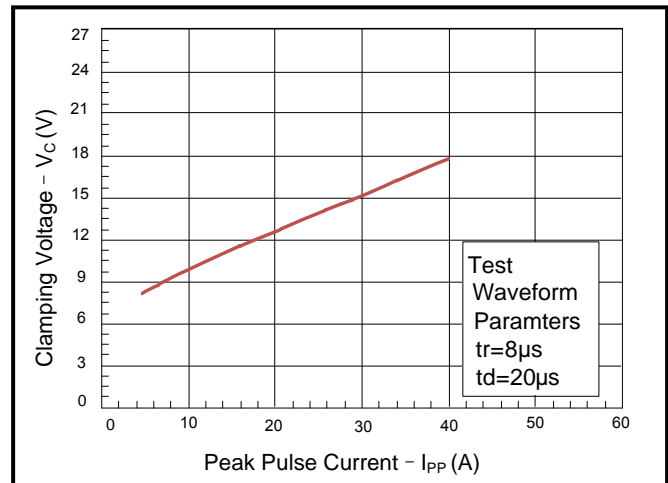

Figure 4: Clamping Voltage vs. Ipp



BNPESD3V3U1UA

ESD Protection Diode

Outline Drawing – SOD-323

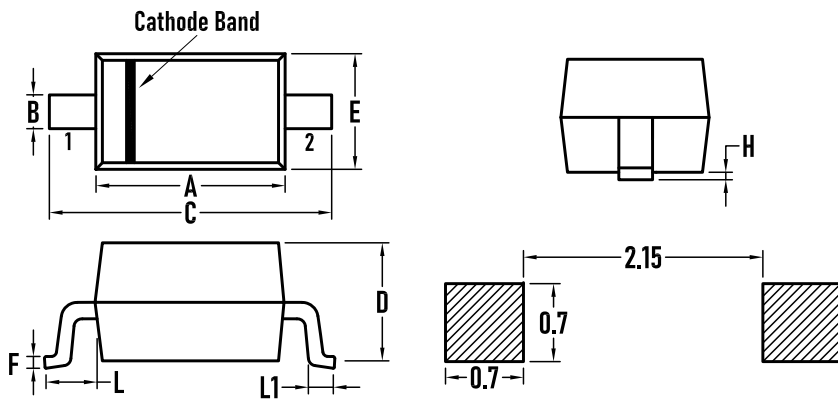

SYMBOL	MILLIMETER		INCHES	
	MIN.	MAX.	MIN.	MAX.
A	1.600	1.800	0.063	0.071
B	0.250	0.350	0.010	0.014
C	2.500	2.700	0.098	0.106
D	–	1.000	–	0.039
E	1.200	1.400	0.047	0.055
F	0.080	0.150	0.003	0.006
L	0.475REF		0.019REF	
L1	0.250	0.400	0.010	0.016
H	0.000	0.100	0.000	0.004

Packaging Tape - SOD-323

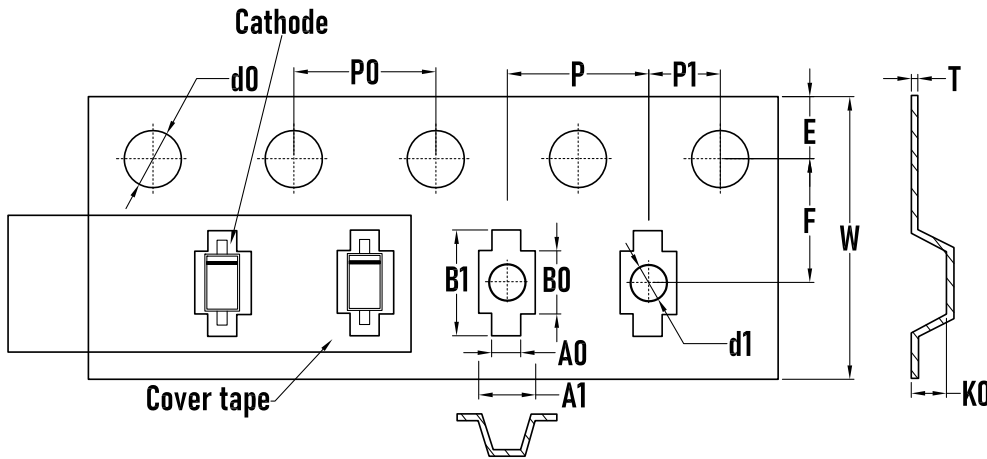

SYMBOL	MILLIMETER
A0	0.80±0.10
A1	1.48±0.10
B0	1.80±0.10
B1	3.00±0.10
d0	1.55±0.10
d1	1.00±0.05
E	1.75±0.10
F	3.50±0.10
K0	1.05±0.10
P	4.00±0.10
P0	4.00±0.10
P1	2.00±0.10
W	8.00±0.30
T	0.25 ±0.05

Packaging Reel

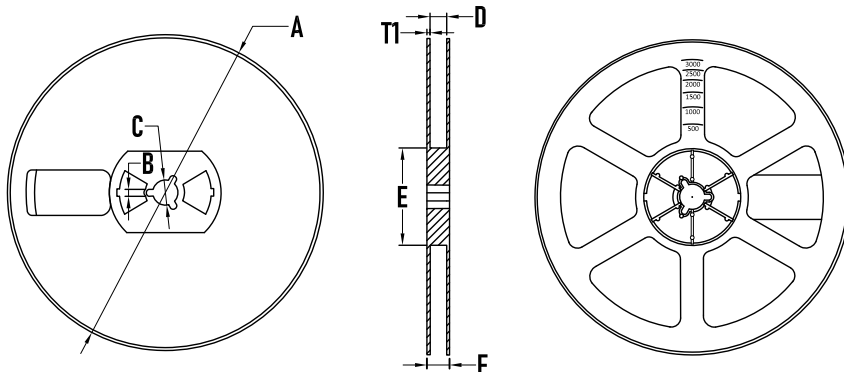

SYMBOL	MILLIMETER
A	177.8±0.2
B	2.7±0.2
C	13.5±0.2
D	9.6±0.3
E	54.5±0.2
F	12.3±0.3
T1	1.0±0.2
Quantity	3000PCS

**BORN SEMICONDUCTOR, INC. ALL
RIGHT RESERVED**

Specifications are subject to change without notice.

Please refer to <http://www.born-tw.com> for current information.

Revision: 2022-Jan-1-A

