

Features

- 120Watts peak pulse power ($t_p = 8/20\mu s$)
- Bidirectional configurations
- Solid-state silicon-avalanche technology
- Low clamping Voltage
- Low leakage current
- Protection one data/power line
- IEC 61000-4-2 $\pm 30kV$ contact ; $\pm 30kV$ air
- IEC 61000-4-4 (EFT) 40A (5/50ns)
- IEC 61000-4-5 (Lightning) 8A (8/20 μs)

Package

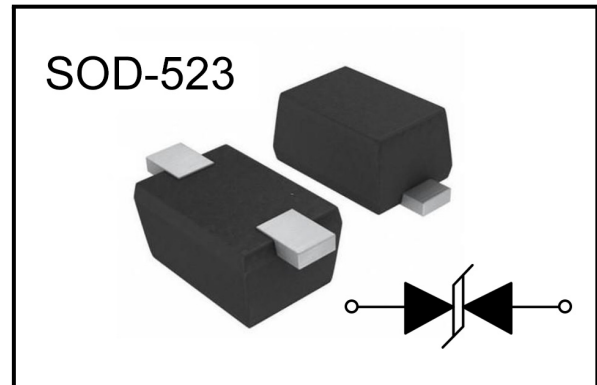

Applications

- Microprocessor based equipment
- Personal Digital Assistants (PDA's)
- Notebooks, Desktops, and Servers
- Portable Instrumentation
- Pagers Peripherals

Mechanical Characteristics

- SOD523 package
- Molding compound flammability rating: UL 94V-0
- Packaging: Tape and Reel
- RoHS/WEEE Compliant

Marking

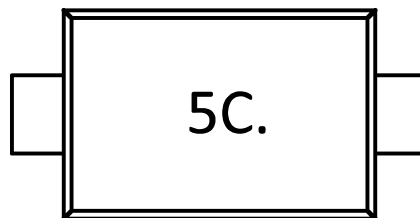

Ordering information

Order code	Package	Base qty	Delivery mode
BNLESD5D5.0CT1G	SOD-523	5k	Tape and reel



Electrical Parameters ($T_A = 25^\circ\text{C}$ unless otherwise noted)

Symbol	Parameter
I_{PP}	Maximum Reverse Peak Pulse Current
V_C	Clamping Voltage @ I_{PP}
V_{RWM}	Peak Reverse Working Voltage
I_R	Reverse Leakage Current @ V_{RWM}
V_{BR}	Breakdown Voltage @ I_T
I_T	Test Current

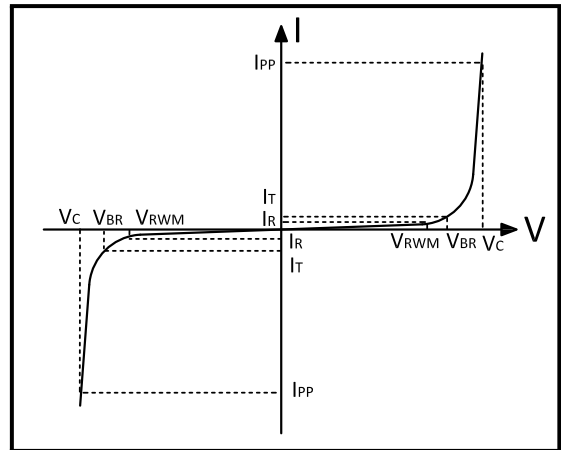

Note: 8/20us pulse Waveform.

Absolute Maximum Rating

Rating	Symler	Value	Units
Peak Pulse Power ($t_p = 8/20\mu\text{s}$)	P_{PP}	120	Watts
Peak Pulse Current ($t_p = 8/20\mu\text{s}$)	I_{PP}	8	A
ESD per IEC 61000-4-2 (Air)	V_{ESD}	30	KV
ESD per IEC 61000-4-2 (Contact)		30	
Lead Soldering Temperature	T_L	260(10seconds)	$^\circ\text{C}$
Junction Temperature	T_J	-55 to + 150	$^\circ\text{C}$
Storage Temperature	T_{stg}	-55 to + 150	$^\circ\text{C}$

Electrical Characteristics

Parameter	Symler	Conditions	Min	Typical	Max	Units
Reverse Stand-Off Voltage	V_{RWM}	–	–	–	5.0	V
Reverse Breakdown Voltage	V_{BR}	$I_T = 1\text{mA}$	6.2	7.5	9.5	V
Reverse Leakage Current	I_R	$V_{RWM} = 5\text{V}, T = 25^\circ\text{C}$	–	–	0.5	μA
Clamping Voltage	V_C	$I_{PP} = 8\text{A}, t_p = 8/20\mu\text{s}$	–	11	15	V
Junction Capacitance	C_j	$V_R = 0\text{V}, f = 1\text{MHZ}$	–	18	23	pF





BNLESD5D5.0CT1G

ESD Protection Diode

Typical Characteristics

Figure 1: Peak Pulse Power vs. Pulse Time

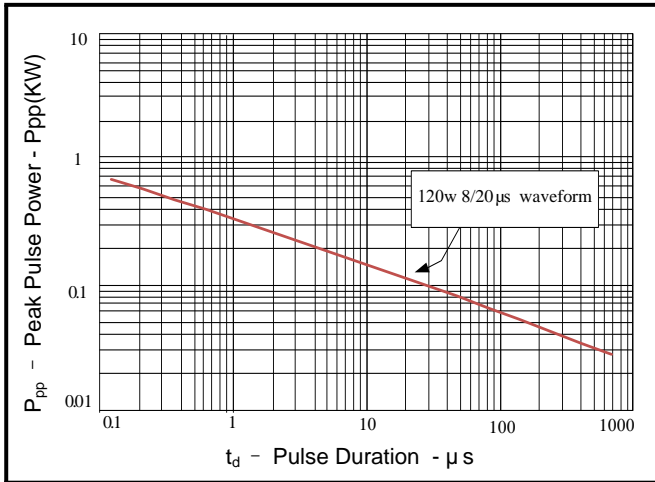

Figure 2: Power Derating Curve

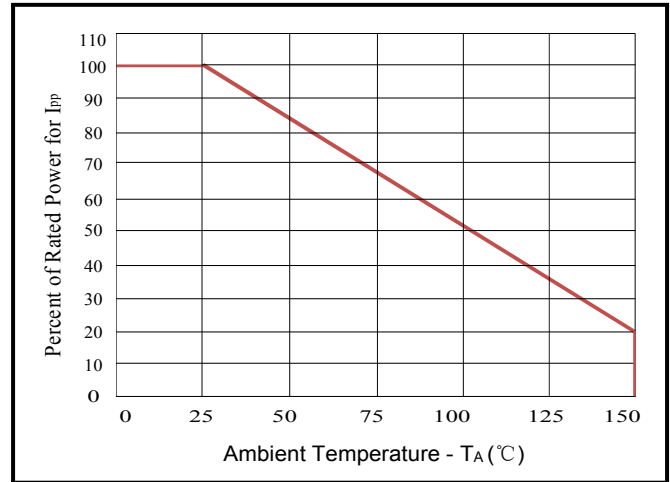

Figure 3: Pulse Waveform

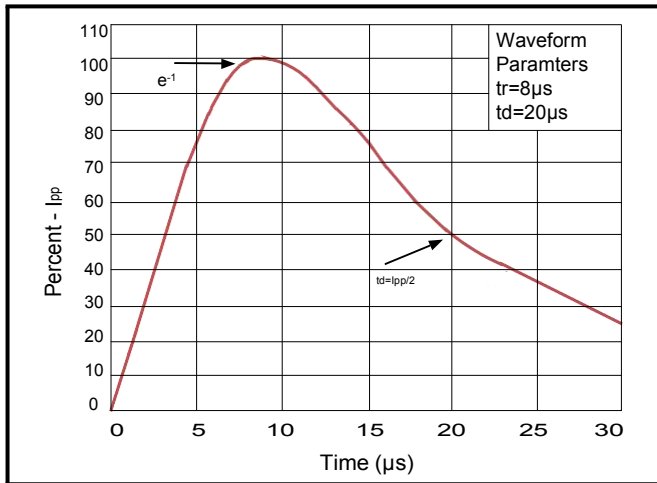
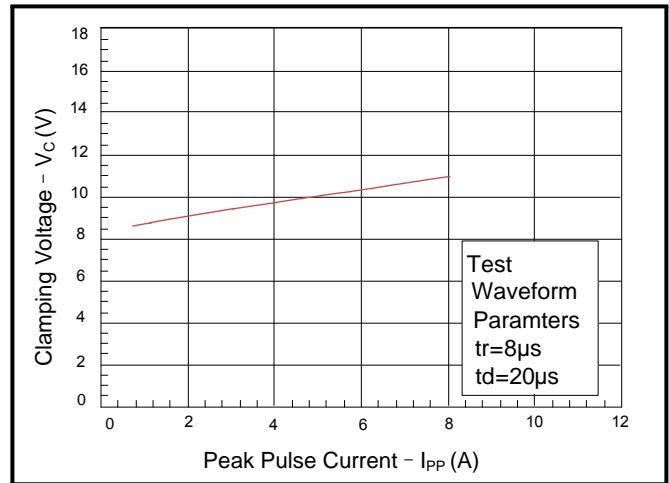

Figure 4: Clamping Voltage vs. I_PP



BNLESD5D5.0CT1G

ESD Protection Diode

Outline Drawing – SOD-523

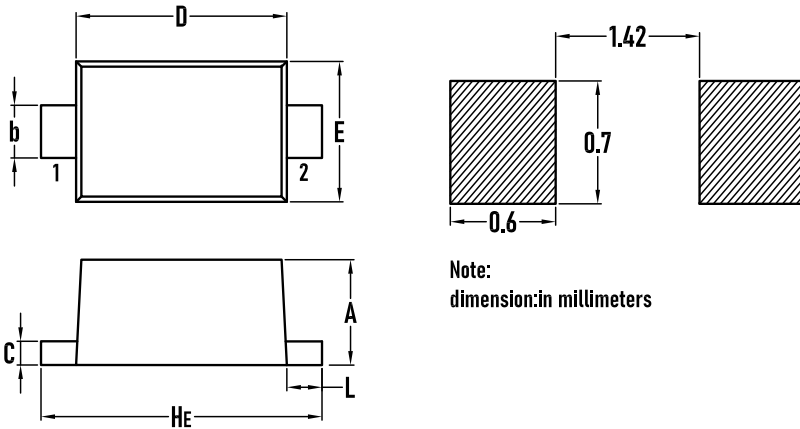

SYMBOL	MILLIMETER		INCHES	
	MIN.	MAX.	MIN.	MAX.
A	0.50	0.70	0.020	0.028
b	0.25	0.35	0.010	0.014
C	0.07	0.20	0.0028	0.0079
D	1.10	1.30	0.043	0.051
E	0.70	0.90	0.028	0.035
H _E	1.50	1.70	0.059	0.067
L	0.15	0.25	0.006	0.010

Packaging Tape - SOD-523

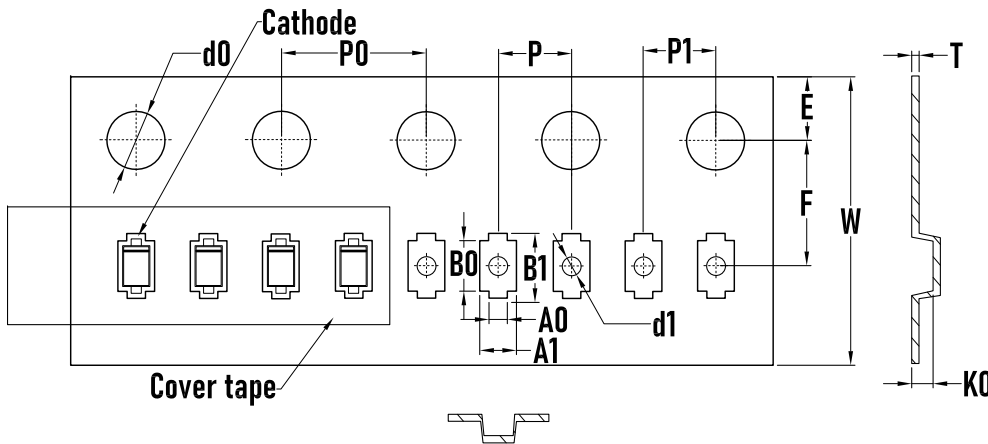

SYMBOL	MILLIMETER
A0	0.50±0.10
A1	1.00±0.10
B0	1.30±0.10
B1	1.80±0.10
d0	1.55±0.10
d1	0.50±0.05
E	1.75±0.10
F	3.50±0.10
K0	0.65±0.10
P	2.00±0.10
P0	4.00±0.10
P1	2.00±0.10
W	8.00±0.30
T	0.2 ±0.05

Packaging Reel

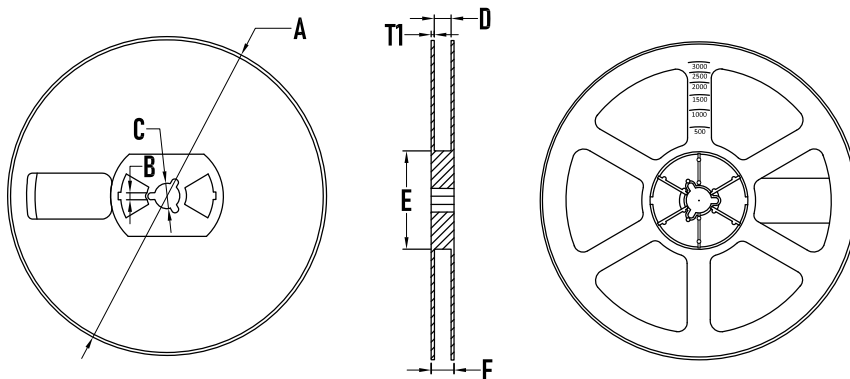

SYMBOL	MILLIMETER
A	177.8±0.2
B	2.7±0.2
C	13.5±0.2
D	9.6±0.3
E	54.5±0.2
F	12.3±0.3
T1	1.0±0.2
Quantity	5000PCS

