

National Semiconductor is now part of
Texas Instruments.

Search <http://www.ti.com/> for the latest technical
information and details on our current products and services.

LM8300/LM8500

Four Wire Resistive Touchscreen Controller with Brownout

1.0 General Description

The LM8300/8500 is a 4-wire resistive touch screen controller. The controller samples and drives the touch screen without the need of any external hardware. The built in 10-bit A/D provides a maximum of 500 coordinate pairs per second (cpps). The data sampled from the touch screen is sent out on the UART at a speed of 38400 bps.

The controller has a power-saving mode which causes the controller to self-power down when no touch is detected on the touch screen for a specified amount of time. In the

self-power down mode, the current drawn is typically less than 2 μ A. The device resumes normal operation when a touch is detected on the touch screen or communication is detected on the UART. In addition to the self-power down mode, the controller can be disabled by pulling the SHUTDOWN pin low. The controller resumes normal operation when the SHUTDOWN pin is tristated or pulled high.

The controller has an internal non-volatile memory storage element to store configuration data such as calibration points or controller configurations.

Devices included in this datasheet:

Device	Operating Voltage	Brownout Voltage	Operating Frequency	I/O Pins	Packages	Temperature
LM8300	3, 5 V	2.7 to 2.9 V	3.27 MHz	18	44 LLP, 44 PLCC, 48 TSSOP	0°C to +70°C
LM8500	5 V	4.17V to 4.5V	3.27, 10 MHz	18	44 LLP, 44 PLCC, 48 TSSOP	0°C to +70°C

2.0 Features

KEY FEATURES

- Supports 4 wire resistive touch panels
- Low power standby current typically less than 2 μ A at 5.5V
- Maximum speed of 500 coordinate pairs per second
- Automatic wake up and return to standby
- 10 bit A/D
- On-chip touch screen current drivers - no external driver required
- UART interface

- Controller configurations are stored in the internal non-volatile storage element
- Touch pressure can be measured

APPLICATIONS

- Personal Digital Assistants
- Smart Hand-Held Devices
- Touch Screen Monitors
- Point-of-Sales Terminals
- KIOSK
- Pagers
- Cell Phones

3.0 Block Diagram

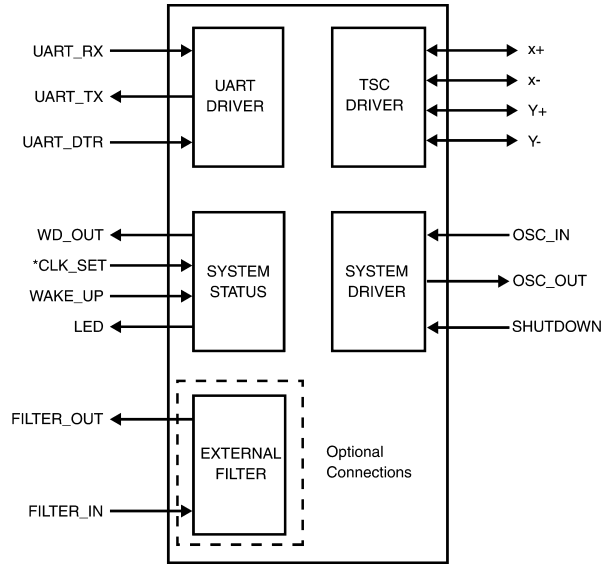

20037201

* This pin is available in the LM8500. It is unused in the LM8300.

4.0 Ordering Information

Part Numbering Scheme

LM	8300	H	VA	9
	Family and Feature Set Indicator	No. Of Pins	Package Type	Temperature
	8300 = Low Brownout Voltage 8500 = High Brownout Voltage	H = 44 Pin I = 48 Pin	LQ = LLP MT = TSSOP VA = PLCC	9 = 0 to +70°C

Table of Contents

1.0 General Description	1
2.0 Features	1
3.0 Block Diagram	2
4.0 Ordering Information	2
5.0 Connection Diagrams	4
6.0 Pin Descriptions	5
7.0 Absolute Maximum Ratings	7
8.0 Electrical Characteristics	7
9.0 Functional Description	8
9.1 GENERAL	8
9.2 ADVANCED PIN DESCRIPTIONS	8
9.3 USART FRAMING FORMAT	9
9.3.1 Data packet format table	9
9.3.2 Command Bytes	9
9.3.3 Advanced Command Bytes Descriptions	10
10.0 Oscillator	12
11.0 Power Save Mode (Low Power Stand-by)	13
12.0 Averaging Algorithm	13
12.1 DELTA ALGORITHM	13
12.2 FOCUS ALGORITHM	14
12.3 COMMUNICATION MODES	14
13.0 Brownout Reset	14
14.0 Calibration	15
14.1 GENERAL CALIBRATION PROCEDURES	16
14.2 CALIBRATION PROCEDURES WITH COORDINATES CHECKING ENABLED	17
14.3 CALIBRATION PROCEDURES WITH COORDINATES CHECKING DISABLED	18
15.0 Revision History	18
16.0 Physical Dimensions	19

5.0 Connection Diagrams

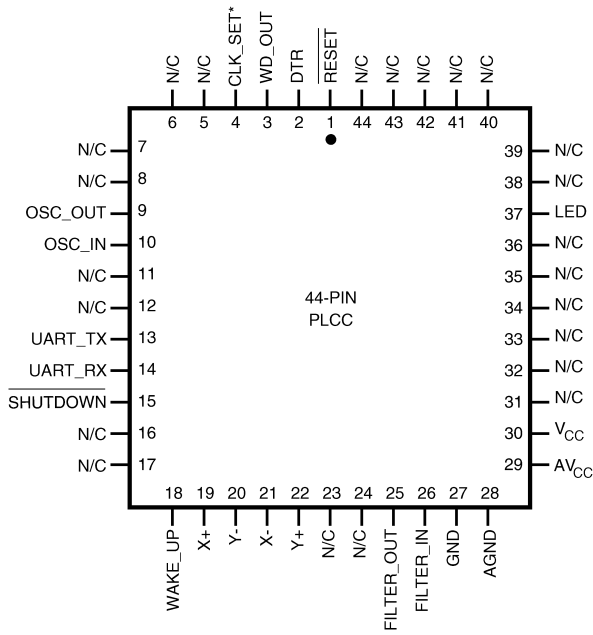

* This pin is available in the LM8500. It is unused in the LM8300.

Top View
Plastic Chip Package
 See NS Package Number V44A

20037202

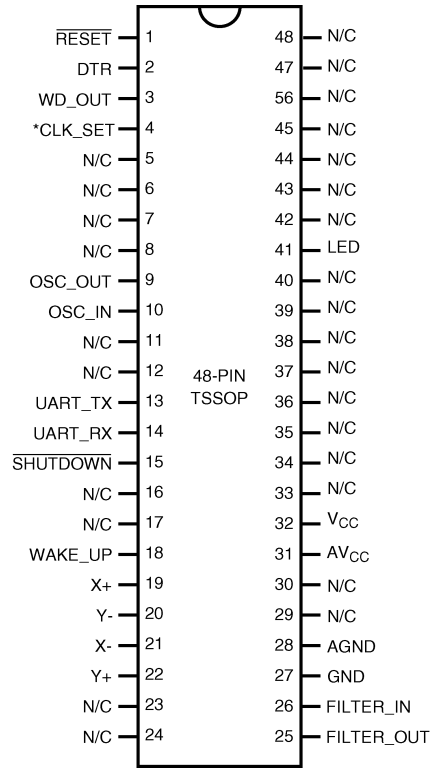

* This pin is available in the LM8500. It is unused in the LM8300.

Top View
TSSOP Package
 See NS Package Number MTD48

20037204

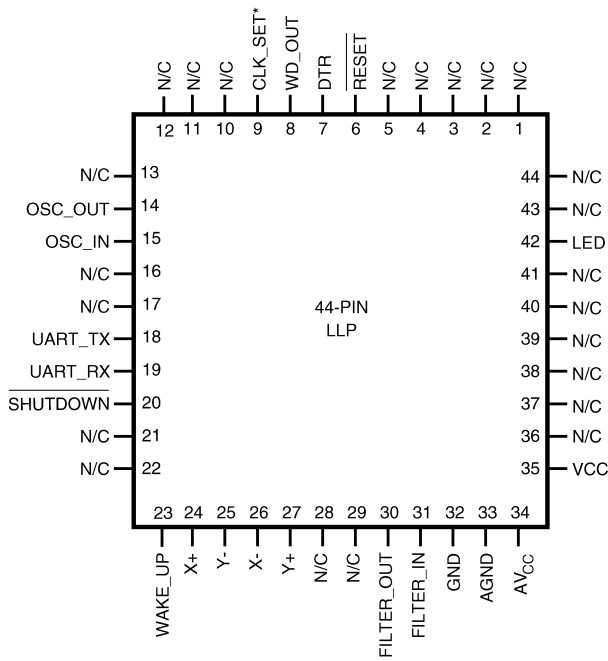

* This pin is available in the LM8500. It is unused in the LM8300.

Top View
LLP Package
 See NS Package Number LQA44A

20037203

6.0 Pin Descriptions

Pinouts for 44- and 48-Pin Packages

Pin Name	Direction	Pin Description	44-Pin LLP	44-Pin PLCC	48-Pin TSSOP
RESET	I	Reset pin, pull low to reset	6	1	1
DTR	I	UART data terminal ready signal	7	2	2
WD_OUT	O	Watchdog output, tie to RESET pin for correct function	8	3	3
CLK_SET ¹	I	Used to set if crystal is 3.3 MHz (low) or 10 MHz (floating or pulled high)	9	4	4
Unused ²			10	5	5
Unused ²			11	6	6
Unused ²			12	7	7
Unused ²			13	8	8
OSC_OUT	O	Clock oscillator output	14	9	9
OSC_IN	I	Clock oscillator input	15	10	10
Unused ²			16	11	11
Unused ²			17	12	12
UART_TX	O	UART transmit pin (inverted for use with standard RS-232 drivers)	18	13	13
UART_RX	I	UART receive pin (inverted for use with standard RS-232 drivers)	19	14	14
SHUTDOWN	I	Shutdown pin, puts the device in halt mode if pulled low	20	15	15
Unused ²			21	16	16
Unused ²			22	17	17
WAKE-UP	I	Used to wake up the processor from halt mode with touch on touch screen	23	18	18
X+	I/O	Drives the X+ wire, also analog input when sampling	24	19	19
Y-	I/O	Drives the Y- wire, also analog input when sampling	25	20	20
X-	I/O	Drives the X- wire, also analog input when sampling	26	21	21
Y+	I/O	Drives the Y+ wire, also analog input when sampling	27	22	22
Unused ²			28	23	23
Unused ²			29	24	24
FILTER_OUT	O	Analog output to the filter	30	25	25
FILTER_IN	I	Analog input from the filter	31	26	26
GND		Digital ground	32	27	27
AGND		Analog ground	33	28	28
AV _{CC}		Analog power supply, connect to filter for best performance	34	29	31
V _{CC}		Digital power supply	35	30	32
Unused ²			X	X	33
Unused ²			X	X	34
Unused ²			36	31	35
Unused ²			37	32	36
Unused ²			38	33	37
Unused ²			39	34	38
Unused ²			40	35	39
Unused ²			41	36	40

6.0 Pin Descriptions (Continued)

Pinouts for 44- and 48-Pin Packages (Continued)

Pin Name	Direction	Pin Description	44-Pin LLP	44-Pin PLCC	48-Pin TSSOP
LED	Output	Optional LED output, low when running, high in halt-mode	42	37	41
Unused ²			3	42	46
Unused ²			4	43	47
Unused ²			5	44	48

Note 1: This is available in the LM8500 only.

Note 2: These pins are for future functional expansions.

7.0 Absolute Maximum Ratings (Note 3)

If Military/Aerospace specified devices are required, please contact the National Semiconductor Sales Office/Distributors for availability and specifications.

Supply Voltage (V_{CC})	7V
Voltage at Any Pin	-0.3V to $V_{CC} + 0.3V$
Total Current into V_{CC} Pin (Source)	200 mA

Total Current out of GND Pin (Sink)	200 mA
Storage Temperature Range	-65°C to +140°C
ESD Protection Level	2 kV (Human Body Model)

Note 3: Absolute maximum ratings indicate limits beyond which damage to the device may occur. DC and AC electrical specifications are not ensured when operating the device at absolute maximum ratings.

8.0 Electrical Characteristics

DC Electrical Characteristics ($0^{\circ}\text{C} \leq T_A \leq +70^{\circ}\text{C}$)

Datasheet min/max specification limits are guaranteed by design, test, or statistical analysis.

Parameter	Conditions	Min	Typ	Max	Units
Operating Voltage		2.7		5.5	V
Power Supply Rise Time		10		50×10^6	ns
Power Supply Ripple (Note 4)	Peak-to-Peak			$0.1 V_{CC}$	V
Supply Current (Note 5)					
High Speed Mode					
CKI = 10 MHz	$V_{CC} = 5.5V$			11.5	mA
CKI = 3.33 MHz	$V_{CC} = 4.5V$			5	mA
HALT Current with BOR Disabled (Note 6)					
High Speed Mode	$V_{CC} = 5.5V$, CKI = 0 MHz		<2	10	μA
Supply Current for BOR Feature	$V_{CC} = 5.5V$			45	μA
High Brownout Trip Level (BOR Enabled)		4.17	4.28	4.5	V
Low Brownout Trip Level (BOR Enabled)		2.7	2.78	2.9	V
Input Levels (V_{IH} , V_{IL})					
Logic High		$0.8 V_{CC}$			V
Logic Low				$0.16 V_{CC}$	V
Internal Bias Resistor for the CKI Crystal/Resonator Oscillator		0.3	1.0	2.5	$\text{M}\Omega$
Hi-Z Input Leakage	$V_{CC} = 5.5V$	-0.5		+0.5	μA
Input Pullup Current	$V_{CC} = 5.5V$, $V_{IN} = 0V$	-50		-210	μA
Port Input Hysteresis		$0.25 V_{CC}$			V
Output Current Levels					
Outputs X+, X-, Y+, Y-					
Source (Note 7)	$V_{CC} = 4.5V$, $V_{OH} = 4.2V$	-10			mA
	$V_{CC} = 2.7V$, $V_{OH} = 2.4V$	-6			mA
Sink (Note 7)	$V_{CC} = 4.5V$, $V_{OL} = 0.3V$	10			mA
	$V_{CC} = 2.7V$, $V_{OL} = 0.3V$	6			mA
Allowable Sink and Source Current per Pin				20	mA
All Others					
Source (Weak Pull-Up Mode)	$V_{CC} = 4.5V$, $V_{OH} = 3.8V$	-10			μA
	$V_{CC} = 2.7V$, $V_{OH} = 1.8V$	-5			μA
Source (Push-Pull Mode)	$V_{CC} = 4.5V$, $V_{OH} = 3.8V$	-7			mA
	$V_{CC} = 2.7V$, $V_{OH} = 1.8V$	-4			mA
Sink (Push-Pull Mode) (Note 7)	$V_{CC} = 4.5V$, $V_{OL} = 1.0V$	10			mA
	$V_{CC} = 2.7V$, $V_{OL} = 0.4V$	3.5			mA
Allowable Sink and Source Current per Pin				15	mA
TRI-STATE Leakage	$V_{CC} = 5.5V$	-0.5		+0.5	μA
Maximum Input Current without Latchup				± 200	mA
RAM Retention Voltage, V_R (in HALT Mode)		2.0			V

8.0 Electrical Characteristics (Continued)

DC Electrical Characteristics ($0^{\circ}\text{C} \leq T_A \leq +70^{\circ}\text{C}$) (Continued)

Datasheet min/max specification limits are guaranteed by design, test, or statistical analysis.

Parameter	Conditions	Min	Typ	Max	Units
Input Capacitance				7	pF

Note 4: Maximum rate of voltage change must be < 0.5 V/ms.

Note 5: Supply and IDLE currents are measured with CKI driven with a square wave Oscillator, CKO driven 180° out of phase with CKI, inputs connected to V_{CC} and outputs driven low but not connected to a load.

Note 6: The HALT mode will stop CKI from oscillating. Measurement of I_{DD} HALT is done with device neither sourcing nor sinking current; all inputs tied to V_{CC} ; A/D converter and clock monitor and BOR disabled.

Note 7: Absolute Maximum Ratings should not be exceeded.

A/D Converter Electrical Characteristics ($0^{\circ}\text{C} \leq T_A \leq +70^{\circ}\text{C}$) (Single-ended mode only)

Datasheet min/max specification limits are guaranteed by design, test, or statistical analysis.

Parameter	Conditions	Min	Typ	Max	Units
Resolution				10	Bits
DNL	$V_{CC} = 5V$			± 1	LSB
DNL	$V_{CC} = 3V$			± 1	LSB
INL	$V_{CC} = 5V$			± 2	LSB
INL	$V_{CC} = 3V$			± 4	LSB
Offset Error	$V_{CC} = 5V$			± 1.5	LSB
Offset Error	$V_{CC} = 3V$			± 2.5	LSB
Gain Error	$V_{CC} = 5V$			± 1.5	LSB
Gain Error	$V_{CC} = 3V$			± 2.5	LSB
Input Voltage Range	$2.7V \leq V_{CC} < 5.5V$	0		V_{CC}	V
Analog Input Leakage Current				0.5	μA
Analog Input Resistance (Note 8)				6k	Ω
Analog Input Capacitance				7	pF
Operating Current on AV_{CC}	$AV_{CC} = 5.5V$		0.2	0.6	mA

Note 8: Resistance between the device input and the internal sample and hold capacitance.

9.0 Functional Description

9.1 GENERAL

The LM8300/8500 is a 4-wire resistive touch screen controller. The primary communication is through the built in UART operating at a baud rate of 38400. The LM8300/8500 has the ability to measure pressure on the Z-axis, in addition to the X-Y coordinates.

The device has the capability to do a 2, 5, and 13 point calibration. All calibration data is stored in the internal non-volatile storage element. In addition, all settings pertaining to the controller are stored internally. This feature negates the need for external EEPROM.

The device has three built in averaging algorithms: oversampling, delta, and focus. These algorithms help to minimize noise and A/D variation due to noise. Refer to the averaging algorithm section for a more detail explanation. These algorithms are implemented on-chip, freeing the main processor from these tasks. To further minimize noise in extremely noisy environments, the device has the ability to route the signal from the touch panel to an external filtering stage before A/D conversions are performed.

To minimize power consumption, the device can be put into power save mode. The device can be set to go into power save mode automatically or manually by pulling the external shutdown pin low.

9.2 ADVANCED PIN DESCRIPTIONS

CLK_SET — This pin is the selection pin used to determine the operating frequency of the controller. On power up, the controller polls this pin to determine if the operating frequency is set to 10 MHz or 3.3 MHz. If the pin is left floating or tied high, then the operating frequency is 10 MHz. If the pin is tied low, then the operating frequency is set to 3.3 MHz.

Note: This is available on the LM8500 only.

SHUTDOWN — This is the external shut down pin. When pulled low, the controller goes into power saving mode. This selection pin state has higher priority than the internal power save mode settings.

WAKE_UP — This pin is used to wake the controller from power save mode. When the device is in power save mode, the pin must be tied to one of X-Y lines coming from the touch screen panel.

X+ — Connect to X+ terminal of the resistive screen.

X- — Connect to X- terminal of the resistive screen.

Y+ — Connect to Y+ terminal of the resistive screen.

Y- — Connect to Y- terminal of the resistive screen.

Filter_out — Analog output to external filter. The use of the external filter is controlled by sending a command byte of \$A0 on the UART to the controller.

Filter_in — Analog input from external filter. The use of the external filter is controlled by sending a command byte of \$A0 on the UART to the controller.

9.0 Functional Description (Continued)

LED — Optional LED output. When the controller is operating in normal (non power save) mode, a low is output to the pin. When the controller is in power save mode, a high is output to the pin.

RESET — Reset pin. When pulled low, a manual reset is executed. For normal operation, this pin must be pulled high. Under no circumstances should the pin be left floating.

UART_TX — UART transmit pin. The signal is inverted for use with standard RS-232 drivers.

UART_RX — UART receive pin. The signal is inverted for use with standard RS-232 drivers.

DTR — Data Terminal Ready signal for the UART. If a high level is detected on the pin, this signals that the UART is not ready. If a low level is detected on the pin, this signals that the UART is ready.

WD_Out — Watch dog output. For correct operation, this pin should be connected to the RESET pin.

OSC_OUT — Clock oscillator output pin.

OSC_IN — Clock oscillator input pin

GND — Digital Ground

AGND — Analog ground

DV_{CC} — Digital power supply.

AV_{CC} — Analog power supply. For best performance, this pin should be connected to a filter.

Users of the LLP package are cautioned to be aware that the central metal area and the pin 1 index mark on the bottom of the package may be connected to GND. See figure below:

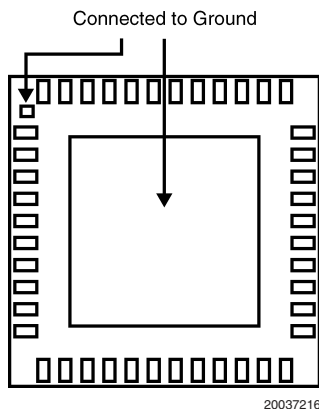

FIGURE 1. LLP Package Bottom View

9.3 USART FRAMING FORMAT

The device communicates with the touch screen driver using the UART set at a baud rate of 38400, 8, n, 1.

All communication from the host software and the controller consists of a command byte and occasionally data byte(s). If data byte(s) follow a command byte, it must be sent directly after the command byte. If the device is in the power save mode, a delay must be inserted between the wake up command and the command byte. Refer to the Power Save mode section for more details. For every command byte sent to the controller, an acknowledge byte is sent back and sometimes data byte(s).

A command byte is distinguished by having the 7th bit of the command byte set (1). If any data byte(s) is to follow, the 7th bit of the data byte is reset (0).

Data packets sent to the host software can be either four or five bytes in length. If the pressure measurement is enabled, five bytes are sent. If the pressure measurement is not enabled, four bytes are sent.

The first byte of each data packet is a header byte. This header byte is used to synchronize and differentiate between four or five byte packages. If a four byte data package is sent, the 4th bit of the header byte is reset (0). If a five byte data package is sent, the 4th bit of the header byte is set (1).

The 6th bit of the second byte of the data packet is used to indicate the touch state. If the bit is set (1), then a touchdown or continuous touch is detected. If the bit is reset (0), then a liftoff is detected.

9.3.1 Data packet format table

	Bit 7	Bit 6	Bit 5	Bit 4	Bit 3	Bit 2	Bit 1	Bit 0
Byte 1	1	0	0	L	0	0	0	0
Byte 2	0	S	X ₂	X ₁	X ₀	Y ₂	Y ₁	Y ₀
Byte 3	0	X ₉	X ₈	X ₇	X ₆	X ₅	X ₄	X ₃
Byte 4	0	Y ₉	Y ₈	Y ₇	Y ₆	Y ₅	Y ₄	Y ₃
Byte 5	0	Z ₆	Z ₅	Z ₄	Z ₃	Z ₂	Z ₁	Z ₀

L - Package length. (0 = 4 bytes, 1 = 5 bytes)

S - Touch state (0 = liftoff, 1 = touchdown or continuous touch)

X_x - X position (10 bit value)

Y_y - Y position (10 bit value)

Z_z - Z position (7 bit value), this byte is only transmitted if the pressure measurement is enabled

9.3.2 Command Bytes

PC Command	PC Byte 1	PC Byte 2	TSC Byte 1	TSC Byte 2
Read clock-speed (3,33MHz, 10MHz)	\$B0		\$CA	\$00, \$01
Read parameters	\$B1		\$CA	Section 9.3.3 Advanced Command Bytes Descriptions
Read software version number	\$B2		\$C7	Section 9.3.3 Advanced Command Bytes Descriptions
Read # of calibration points	\$B3		\$CA	\$00, \$02, \$05, \$0D

9.0 Functional Description (Continued)

PC Command	PC Byte 1	PC Byte 2	TSC Byte 1	TSC Byte 2
Read stored calibration points	\$B4		\$CA	<i>Section 9.3.3 Advanced Command Bytes Descriptions</i>
Set focus value (# of pixels on touch panel)	\$B8	\$0-\$3F	\$CA	\$00-\$3F
Set # of samples per coordinate (1, 2, 4, 8, 16, 32)	\$BA	\$01, \$02, \$04, \$08, \$10, \$20	\$CA	\$01, \$02, \$04, \$08, \$10, \$20
Set communication mode (stream, touchdown, liftoff)	\$BB	\$01, \$02, \$04	\$CA	\$01, \$02, \$04
Set max delta (# of pixels from predicted coordinate)	\$BC	\$00-\$3F	\$CA	\$00-\$3F
Set calibration points	\$BD	<i>Section 9.3.3 Advanced Command Bytes Descriptions</i>	\$CA	<i>Section 9.3.3 Advanced Command Bytes Descriptions</i>
Set minimum pressure	\$BE	\$00-\$7F	\$CA	\$00-\$7F
Toggle disable/enable external filter path	\$A0		\$CA	\$00, \$01
Toggle disable/enable self power-down	\$A2		\$CA	\$00, \$01
Toggle disable/enable echo mode	\$A3		\$CA	\$00, \$01
Toggle disable/enable pressure measurements	\$A4		\$CA	\$00, \$01

PC Command	PC Byte 1	PC Byte 2	TSC Byte 1	TSC Byte 2
Toggle disable/enable calibration coordinate check	\$A5		\$CA	\$00, \$01
Wakeup	\$A7			
Shutdown	\$A8		\$CA	
Soft reset	\$AF		\$CA	\$CB, \$CC
TSC Replies				
Timeout			\$CF	
Re-send			\$CE	
Self test failed			\$CC	
Self test ok			\$CB	
Acknowledge			\$CA	
Calibration coordinates ok			\$C4	
Error / buffer overrun			\$C8	
Software version			\$C7	\$0-\$7F
Data transmit			\$80/\$90	Payload (3/4 bytes)

9.3.3 Advanced Command Bytes Descriptions

Unless otherwise mentioned, all values are in hex.

\$B0: Read clock-speed

Reply Byte #1: \$CA (Acknowledge)

Byte #2: Clock readout (0 = 3.3MHz, 1 = 10MHz)

CLK_SEL pin tells the firmware which oscillator speed is used. If the CLK_SEL input pin is floating or pulled high a 10.0MHz oscillator must be connected. If the pin is pulled low a 3.3MHz oscillator must be connected. This command enables the driver software to determine which oscillator speed is used with the touch screen controller, as this determines the maximum coordinate pair per second data rates.

Note: This is available in the LM8500 only.

\$B1: Read parameters

Reply Byte #1: \$CA (Acknowledge)

Reply Byte #2: First byte in software version number, year 20 (00-99)

Reply Byte #3: Communication mode (1 = stream, 2 = touchdown, 4 = liftoff)

Byte #4: Wakeup on touch (0 = disabled, 1 = enabled)

Reply Byte #5: Number of samples (1,2, 4, 8, 16 or 32)

Byte #6: Clock readout (0 = 3.3MHz, 1 = 10MHz)

Byte #7: Second byte in software version number, month (1-12)

Byte #8: Third byte in software version number, day (1-31)

Byte #9: Focus value (0-63)

Byte #10: Max delta (0-63)

9.0 Functional Description (Continued)

Byte #11: Number of calibration coordinates (0, 2, 5 or 13)

Byte #12: Toggle-flags:

Bit #5: calibration coordinates check (0=disabled, 1=enabled)

Bit #4: Pressure measurement (0=disabled, 1=enabled)

Bit #3: Echo mode (0=disabled, 1=enabled)

Bit #2: Self Power-Down mode (0=disabled, 1=enabled)

Bit #1: Unused

Bit #0: External filter path (0=disabled, 1=enabled)

Byte #13: Pressure threshold for valid touch

This command allows the user to read all the selected parameters. It is primary intended to aid in debugging. This command can also be used if a configuration utility needs to determine the current setting of controller.

\$B2: Read software version number

Reply Byte #1: \$C7 (Software version number)

Byte #2: First byte in version number, year 20 (00-99)

Byte #3: Second byte in version number, month (1-12)

Byte #4: Third byte in version number, day (1-31)

\$B3: Read # of calibration points

Reply Byte #1: \$CA (Acknowledge)

Byte #2: (\$00 — no calibration done, \$02 — 2 points, \$05 — 5 points or \$0D — 13 points)

\$B4: Read stored calibration points

Reply Byte #1: \$CA (Acknowledge)

Byte #2: (\$00 — no calibration done, \$02 — 2 points, \$05 — 5 points or \$0D — 13 points)

Byte #3: X-max (2 MSB for coordinate 1)

Byte #4: X-min (8 LSB for coordinate 1)

Byte #5: Y-max (2 MSB for coordinate 1)

Byte #6: Y-min (8 LSB for coordinate 1)

Continue until all coordinates have been sent. A zero is send back if calibration has not been performed and there are no data bytes.

\$B8: Set focus value

Byte #2: Focus value (0-63)

Reply Byte #1: \$CA (Acknowledge)

Byte #2: Focus value (0-63)

The set focus command allows the setting of different values to improve touch screen focusing. Focusing is defined as the ability of the touch screen controller to detect exactly identical coordinate values from measurement to measurement if the pointer on the touch screen has not moved. The focus values are equivalent to pixels of touch screen resolution. If for example a value of 2 is selected, this means that every coordinate value that is within two pixels of the previously measured coordinate value is considered to be identical to that previous value and that in this case the touch screen controller transmits the previous coordinate information. This keeps the mouse pointer steady at the point being touched, rather than "jumping around" the point. A Focus value of zero disables the focusing algorithm. The default setting is 4.

\$BA: Set number of samples per coordinate

Byte #2: Number of samples per coordinate (\$01 - 1 samples/coordinate, \$02 - 2 samples/coordinate, \$04

- 4 samples/coordinate, \$08 - 8 samples/coordinate, \$10 - 16 samples/coordinate, \$20 - 32 samples/coordinate)

Reply Byte #1: \$CA (Acknowledge)

Byte #2: Number of samples per coordinate (\$01 - 1 samples/coordinate, \$02 - 2 samples/coordinate, \$04 - 4 samples/coordinate, \$08 - 8 samples/coordinate, \$10 - 16 samples/coordinate, \$20 - 32 samples/coordinate)

This command allows the selection of different sample numbers per X, Y, and Z coordinates. The higher the number of samples per X, Y, and Z coordinates, the better the accuracy, but the lower the coordinates per second data rate. The default setting is 8.

\$BB: Set communication mode

Byte #2: Communication mode (\$01 = stream, \$02 = touchdown, \$04 = liftoff)

Reply Byte #1: \$CA (Acknowledge)

Byte #2: Communication mode (\$01 = stream, \$02 = touchdown, \$04 = liftoff)

See the communication modes section for a description of the stream, touchdown and liftoff modes. This command selects the communication mode. The default setting is stream mode.

\$BC: Set max delta

Byte #2: Max delta value (0-63)

Reply Byte #1: \$CA (Acknowledge)

Byte #2: Max delta value (0-63)

See the averaging algorithms section for a detailed description of this setting. Simply put, this command sets how much the "coordinate velocity" can change from one coordinate to the next. The default setting is 8.

\$BD: Set calibration points

Byte #2: High nibble: Number of calibration points (\$01 = two, \$02 = five, \$04 = thirteen)

Low nibble: Active calibration cross (1-13 = cross #)

Reply Byte #1: \$CA (Acknowledge)

Byte #2: High nibble: Number of calibration points (\$01=two, \$02=five, \$04=thirteen)

Low nibble: Active calibration cross # (1-13)

Refer to the calibration section for details.

\$BE: Set minimum pressure

Byte #2: Minimum pressure value (0-127)

Reply Byte #1: \$CA (Acknowledge)

Byte #2: Minimum pressure value (0-127)

This setting controls how high the pressure (Z-axis) must be in order for samples to be accepted. Setting this value too low may result in having faulty coordinates accepted. This value is internally multiplied by two in the controller (due to the 7-bit limitation in the communication format, which can not send 8-bit values larger than 127 in one byte). The default setting is 40.

\$A0: Toggle disable/enable external filter path

Reply Byte #1: \$CA (Acknowledge)

Byte #2: (0 = now disabled, 1 = now enabled)

This command enable/disable external filter path. The external filter path enabled option will require the addition of a single external low pass filter (either R/C or active OpAmp based), which is then applied to the touch screen signal

9.0 Functional Description (Continued)

lines. This option can be used in high noise environments to significantly improve performance and accuracy of the touch screen controller.

The default setting is filter path enabled.

\$A2: Toggle disable/enable self-power down

Reply Byte #1: \$CA (Acknowledge)

Byte #2: (0 = now disabled, 1 = now enabled)

This command can switch between self-power down mode enable or disabled. Refer to the Power Save Mode section for details. The default setting is Self-Power Down mode enabled. If the echo mode is enabled, any command byte send to the device will be echo back and executed.

\$A3: Toggle disable/enable echo mode

Reply Byte #1: \$CA (Acknowledge)

Byte #2: (0 = now disabled, 1 = now enabled)

The echo mode is available for debugging purposes. If enabled, the touch screen controller will echo back any data that is received via the UART interface.

The default setting is Echo mode disabled.

\$A4: Toggle disable/enable pressure measurement

Reply Byte #1: \$CA (Acknowledge)

Byte #2: (0 = now disabled, 1 = now enabled)

The pressure measurement sets the touch screen to also sample the Z-axis when reading the X and Y coordinates.

The default setting is pressure measurement enabled.

\$A5: Toggle disable/enable calibration checking.

Reply Byte #1: \$CA (Acknowledge)

Byte #2: (0 = now disabled, 1 = now enabled)

If the cablibration checking is enabled, the cablibration maping must be the values shown in ??? to ???.

\$A7: Wakeup

There is no reply byte to this command.

When the self-power down mode of the device is enabled, the touch screen driver must send a wakeup command prior to any command byte(s). If the self-power down mode of the TSC is enabled. The wakeup command must also to be sent if the driver puts the TSC in power-down mode via the shutdown command.

\$A8: Shutdown

Reply Byte #1: \$CA (Acknowledge)

When the TSC driver wants the controller to go into power save mode it sends a shutdown command to the controller. The driver needs to send a wakeup to the controller before starting up the communication again.

With the TSC has the self-power-down mode enabled, then a touchdown on the touch screen will wake-up the TSC from shutdown mode in addition to sending the wake up command. If the self-power-down mode is disabled, then only the wakeup command can wake-up the controller from shutdown mode (i.e. wake-up on touchdown is disabled).

\$AF: Soft reset (restart the controller)

Reply Byte #1: \$CA (Acknowledge)

Byte #2: \$CB/\$CC (Self test OK/Self test fail)

When the PC driver sends the soft reset command, the touch screen controller executes a soft reset, which clears and re-initializes all internal RAM configuration registers from on-chip FLASH and performs a self-check of internal RAM and program memory.

CONTROLLER REPLIES

\$CF: Timeout.

Communication timeout has occurred, and current command has been aborted.

\$CE: Re-send

Request the TSC driver to resend the last command. This command is used if the controller does not understand the received command or a buffer overrun condition occurs.

\$CC: Self test fail (done at startup, reset, and after calibration)

\$CB: Self test OK (done at startup, reset, and after calibration)

\$CA: Acknowledge

\$C4: Calibration coordinates OK

This is sent if the coordinates are within the predefined value.

\$C8: Error / TX Buffer overrun

This is added to the last place in transmit buffer to signal that a buffer overrun has occurred.

\$C7: Software Version number

Byte #2: First byte of version number

Byte #3: Second byte of version number

Byte #4: Third byte of version number

\$80: Format tablet for Z-axis disabled (see Format Table section for more info.)

Byte #2: Status, low X and low Y

Byte #3: High X

Byte #4: High Y

\$90: Format tablet for Z-axis enabled (see Format Table section for more info.)

Byte #2: Status, low X and low Y

Byte #3: High X

Byte #4: High Y

Byte #5: Z-axis (0-127)

10.0 Oscillator

OSC_IN is the clock input while OSC_OUT is the clock generator output to the crystal. *Table 1. Crystal Oscillator Configuration,*

$T_A = 25^\circ\text{C}$, $V_{CC} = 5\text{V}$ shows the component values required for various standard crystal values. *Figure 2* shows the crystal oscillator connection diagram.

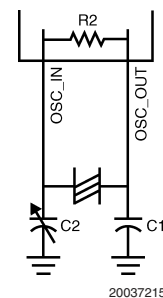

FIGURE 2. Crystal Oscillator

10.0 Oscillator (Continued)

TABLE 1. Crystal Oscillator Configuration,
 $T_A = 25^\circ\text{C}$, $V_{CC} = 5\text{V}$

C1 (pF)	C2 (pF)	CKI Freq. (MHz)
18	18	10
18–36	18–36	3.27

The crystal and other oscillator components should be placed in close proximity to the OSC_IN and OSC_OUT pins to minimize printed circuit trace length.

The values for the external capacitors should be chosen to obtain the manufacturer's specified load capacitance for the crystal when combined with the parasitic capacitance of the trace, socket, and package (which can vary from 0 to 8 pF). The guideline in choosing these capacitors is:

Manufacturer's specified load cap = $(C_1 * C_2) / (C_1 + C_2) + C_{\text{parasitic}}$

C_2 can be trimmed to obtain the desired frequency. C_2 should be less than or equal to C_1 .

11.0 Power Save Mode (Low Power Stand-by)

The power consumption of the controller can be minimized by enabling the low power stand by mode. The power save mode can be controlled internally by sending a command of \$A2 to the controller, externally by pulling the SHUTDOWN pin low, or by issuing a driver shutdown command of \$A8.

The self power down mode is enabled/disabled by sending a command of \$A2 to the controller. When enabled, the controller automatically goes into low power stand by if no more touch activity is detected or if there is no UART communication. The controller automatically comes out of low power stand by mode when a touch is detected on the touch panel or if an incoming communication on the UART is detected. In the low power stand by mode, all activity is disabled, including the oscillator. Also, the LED pin is driven high. To wake up the controller on the UART, the wake up command byte must be sent, followed by a minimum time delay of 1ms for the LM8500 and 3ms for the LM8300 before sending any command byte. The delay time is needed to allow the oscillator to restart and stabilize. *Table 2. Startup Times* shows the average startup time for a given operating frequency.

The SHUTDOWN pin will shut down the controller when pulled low. When the SHUTDOWN pin is pulled low, the controller will continue to be in the low power stand by mode until the pin is pulled high or released. While the SHUTDOWN pin is pulled low, all activities are stopped and any touch or communication will be ignored. Immediately following the SHUTDOWN pin being released or pulled high, the controller clears the UART transmit and receive buffers and resumes normal operation.

The controller can be put in the low power stand by mode by sending a \$A8 command to it. Upon receiving this command, the controller goes into low power stand by mode. If the self power down mode is enabled and the controller is put into low power stand by mode, the controller will wake up if the wake up command (\$A7) is received or if a touch is detected on the touch panel. If the self power down mode is disabled and the controller is put into low power stand by mode, the controller can only be woken up if it receives the wakeup

command. After the controller wakes up, the UART transmit and receive buffers are cleared and resume normal operation.

TABLE 2. Startup Times

CKI Frequency	Startup Time
10 MHz	1–10 ms
3.33 MHz	3–10 ms

12.0 Averaging Algorithm

To achieve better accuracy and noise filtering, each X, Y, and Z coordinate is oversampled by specific amount. The possible oversampling settings are 1, 2, 4, 8, 16, and 32. The factory setting is 8. The greater the oversampling, the greater the accuracy, but the lower the CPPS.

Samples per coordinate vs. CPPS for LM8300

Samples per coordinate	Coordinate pairs per second (CPPS)
1	250
2	220
4	190
8	150
16	100
32	65

Samples per coordinate vs. CPPS for LM8500

Samples per coordinate	Coordinate pairs per second (CPPS)
1	500
2	430
4	360
8	270
16	190
32	110

12.1 DELTA ALGORITHM

The delta filter is used to remove large variations in sampled values due to noise and glitches. The delta filter tries to predict where the next coordinate could be. This is done by taking the two previous coordinates and subtracting one from the other, producing a delta value. This delta value is then added or subtracted to the last coordinate. The resulting value is the predicted coordinate. If the new sampled coordinate is close to this predicted value, then the new value is accepted as valid and is passed to the focus algorithm, provided the focus algorithm is enabled. If the new sampled coordinate is not close to the predicted coordinate, then the value is discarded and is stored to be used in the following delta calculations.

The number by which the new sampled coordinate can differ from the predicted coordinate is controlled by setting the Set Max Delta value. The Set Max Delta value can be from a value of 0-63. The factory default is 8.

12.0 Averaging Algorithm (Continued)

12.2 FOCUS ALGORITHM

The focus algorithm removes some inaccuracy and noise that could cause the coordinate to differ only by a couple of pixels. The focus algorithm is used to eliminate the "jittering" effect of the pointer when the pointer is stationary.

The focus algorithm compares the value of the previous stored value to the value passed from the delta algorithm and determines if the difference is greater than or equal to the Set Focus Value. If the difference is greater or equal to the value in Set Focus Value then the new coordinate is sent out through the UART and stored as the previous value. If the difference is less than the Set Focus Value then the value is discarded and the stored value is set through the UART.

The amount of difference between the new coordinate and the old coordinate is set in the Set Focus Value. This value can be from 0-63 with a value of 0 disabling the focus algorithm. The factory default is 4.

12.3 COMMUNICATION MODES

Liftoff

When set to the liftoff mode, the controller only sends data through the UART on liftoff. The controller continuously samples the touchscreen as long as there is a touch detected on the touchscreen but only the last coordinate is sent out to the UART.

Touchdown

When set to the touchdown mode, the controller only sends data through the UART on touchdown. The controller continuously samples the touchscreen as long as there is a touch detected on the touchscreen but only the first coordinate is sent out to the UART.

Streaming

When set to the streaming mode, the controller continuously sends data through the UART as long as there is a touch detected on the touchscreen.

13.0 Brownout Reset

The device is initialized when the RESET pin is pulled low or the On-chip Brownout Reset is activated.

The RESET input initializes the device when pulled low. The RESET pin must be held low for a minimum of 0.5 μ s for the LM8500 and a minimum of 1.5 μ s for the LM8300 to guarantee a valid reset. Reset should also be wide enough to ensure crystal start-up upon power-up. The R/C circuit shown in *Figure 3* is an optional circuitry that will provide a delay 5 times (5x) greater than the power supply.

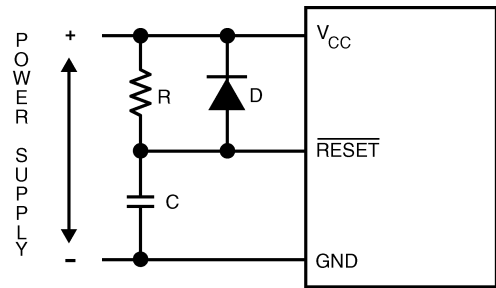

$$R/C > 5 \times \text{Power Supply Rise Time}$$

20037205

FIGURE 3. Optional Reset Circuit using External Reset

When enabled, the device generates an internal reset as V_{CC} rises. While V_{CC} is less than the specified brownout voltage (V_{bor}), the device is held in the reset condition for $t_{id} = 120\text{-}128\ \mu\text{s}$ for the LM8500 and $t_{id} = 360\text{-}384\ \mu\text{s}$ for the LM8300. Once the t_{id} reaches zero, the internal reset is released and the controller resume normal operation. This internal reset will perform the same functions as external reset. Once V_{CC} is above the V_{bor} and t_{id} reaches zero, instruction execution begins. If, however, V_{CC} drops below the selected V_{bor} , an internal reset is generated, and t_{id} is set to 120-128 μs for the LM8500 and 360-384 μs for the LM8300. The device now waits until V_{CC} is greater than V_{bor} , at which time the countdown starts over. When enabled, the functional operation of the device, at frequency, is guaranteed down to the V_{bor} level.

One exception to the above is that the brownout circuit will insert a delay of approximately 3 ms on power up or any time the V_{CC} drops below a voltage of about 1.8V. The device will be held in Reset for the duration of this delay before t_{id} starts count down. This delay starts as soon as the V_{CC} rises above the trigger voltage (approximately 1.8V). This behavior is shown in *Figure 4*.

In Case 1, V_{CC} rises from 0V and the on-chip RESET is undefined until the supply is greater than approximately 1.0V. At this time the brownout circuit becomes active and holds the device in RESET. As the supply passes a level of about 1.8V, a delay of about 3 ms (t_d) is started and t_{id} is preset with 120-128 μs for the LM8500 or 360-384 μs for the LM8300. Once V_{CC} is greater than V_{bor} and t_d has expired, t_{id} starts to count down.

Case 2 shows a subsequent dip in the supply voltage which goes below the approximate 1.8V level. As V_{CC} drops below V_{bor} , the internal RESET signal is asserted. When V_{CC} rises back above the 1.8V level, t_d is started. Since the power supply rise time is longer for this case, t_d has expired before V_{CC} rises above V_{bor} and t_{id} starts immediately when V_{CC} is greater than V_{bor} .

Case 3 shows a dip in the supply where V_{CC} drops below V_{bor} , but not below 1.8V. On-chip RESET is asserted when V_{CC} goes below V_{bor} and t_{id} starts as soon as the supply goes back above V_{bor} .

13.0 Brownout Reset (Continued)

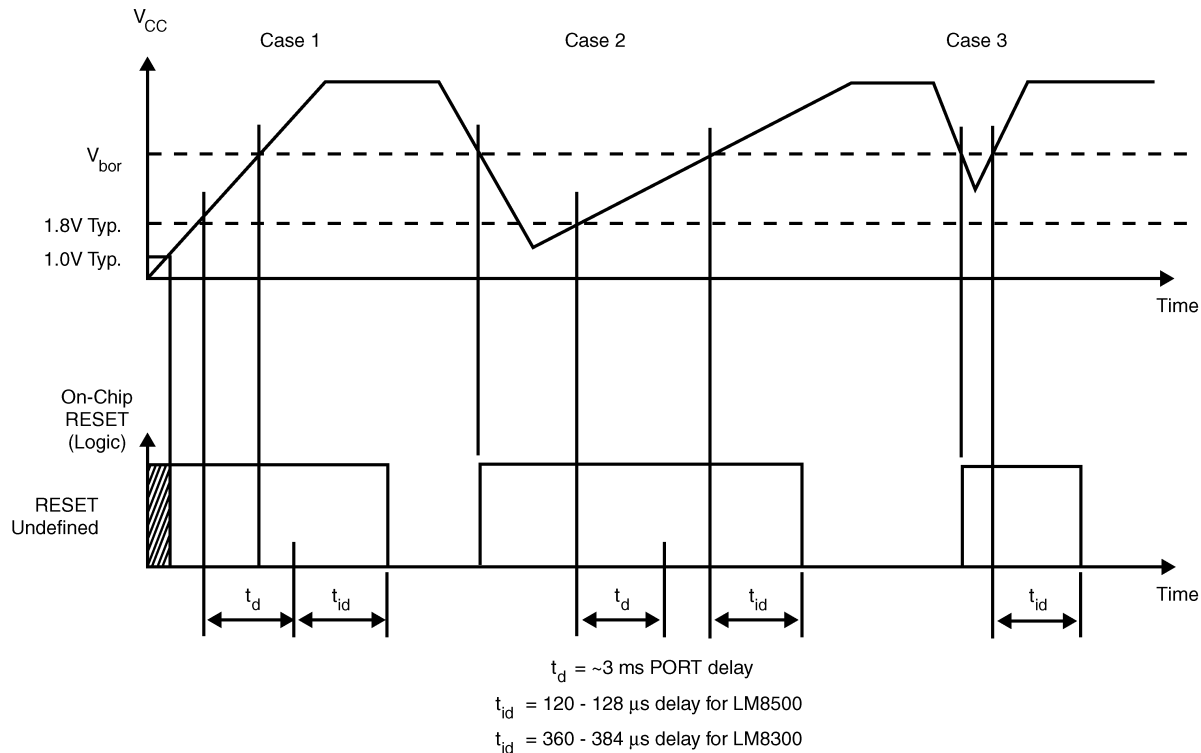

20037206

FIGURE 4. Brownout Reset Operation

The internal reset will not be turned off until t_{id} counts down to zero. The internal reset will perform the same functions as external reset. The device is guaranteed to operate at the specified frequency down to the specified brownout voltage. After the underflow, the logic is designed such that no additional internal resets occur as long as V_{CC} remains above the brownout voltage.

The device is relatively immune to short duration negative going V_{CC} transients (glitches). Proper filtering of the V_{CC} power supply voltage is essential for proper brownout functionality. Power supply decoupling is vital even in battery powered systems.

There are two optional brownout voltages. The part numbers for the two versions of this device are:

LM8500, V_{bor} = high voltage range.

LM8300, V_{bor} = low voltage range.

Refer to the device specifications for the actual V_{bor} voltages.

High brownout voltage devices are guaranteed to operate at 10MHz down to the high brownout voltage. Low brownout voltage devices are guaranteed to operate at 3.33MHz down to the low brownout voltage. Low brownout voltage devices are not guaranteed to operate at 10MHz down to the low brownout voltage.

Under no circumstances should the RESET pin be allowed to float. The RESET input may be connected to an external pull-up resistor to V_{CC} or to other external circuitry. The output of the brownout reset detector will always preset t_{id} to

a value between 120-128 μs for the LM8500 and 360-384 μs for the LM8300. At this time, the internal reset will be generated.

The device has a built in watchdog monitoring module to prevent runaway code. To use the watchdog feature, the WD_OUT pin must be connected to the RESET pin. The WD_OUT pin has an internal weak pull-up so that, when the WD_OUT pin is connected to the RESET pin, the RESET pin does not require an external pull-up resistor to V_{CC} .

14.0 Calibration

The device supports two, five, and thirteen point calibration. If desired, the calibration points can be stored internally in the non-volatile storage element. During calibration time, the device has the unique ability to check if the calibration points make sense. For instance, if the desired calibration point was to be at the upper left hand corner, but by accident, the actual point detected was at the lower right hand corner, the device will reject this point. This ensures the calibration process is not performed incorrectly.

The calibration checking, can be enabled or disabled. If the calibration checking is enabled, the controller will always check the current calibration point being done against the theoretical point and determine if the value is within ± 127 of the raw A/D values. If this option is desired, the touch screen driver must perform the calibration according to the calibration mapping for the two, five, and thirteen points as shown in *Figure 5*, *Figure 6*, and *Figure 7*, respectively. The theoretical values for the two, five, and thirteen points are shown

14.0 Calibration (Continued)

in Table 3. Two Points Calibration, Table 4. Five Points Calibration, and Table 5. Thirteen Points Calibration respectively.

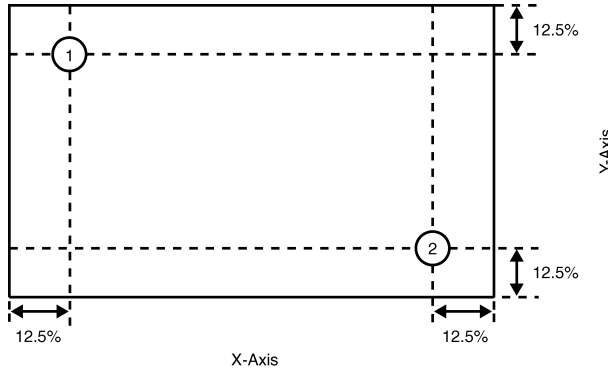

20037207

FIGURE 5. Two Points Calibration Mapping

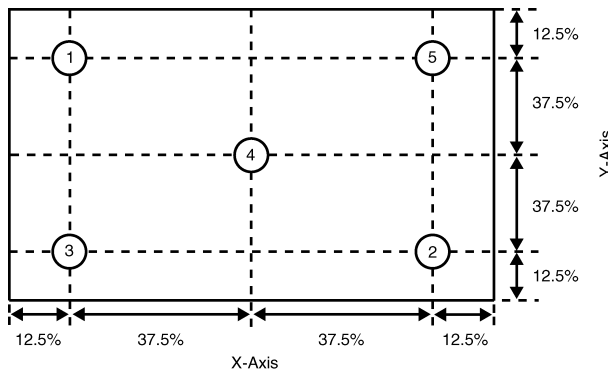

20037208

FIGURE 6. Five Points Calibration Mapping

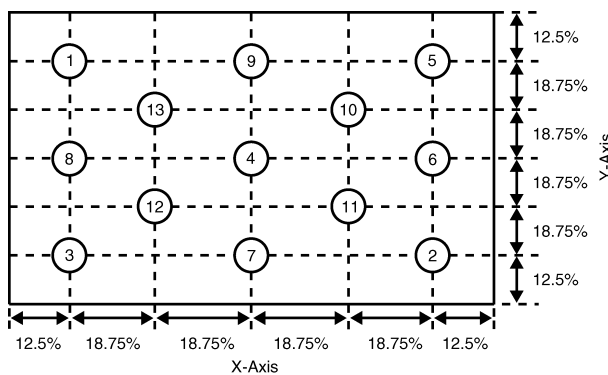

20037209

FIGURE 7. Thirteen Points Calibration Mapping

TABLE 3. Two Points Calibration

Calibration point	Theoretical X-value	Theoretical Y-value
1	127	127
2	895	895

TABLE 4. Five Points Calibration

Calibration point	Theoretical X-value	Theoretical Y-value
1	127	127
2	895	895
3	127	895
4	511	511
5	895	127

TABLE 5. Thirteen Points Calibration

Calibration point	Theoretical X-value	Theoretical Y-value
1	127	127
2	895	895
3	127	895
4	511	511
5	895	127
6	895	511
7	511	895
8	127	511
9	511	127
10	623	319
11	623	623
12	319	623
13	319	319

14.1 GENERAL CALIBRATION PROCEDURES

Calibration is invoked by sending a command byte of \$BD followed by a command byte to the device. The command byte is broken into two parts: the high nibble states the number of calibration points to perform and the lower nibble states the active calibration point. For example, to do the first calibration point for the two point calibration, the command bytes of \$BD and \$11 are sent to the device. The device then echos \$BD and \$11 back to the TS driver and waits for a touch on the panel. When a touch is detected, the device checks to see if the point is within the specified parameters if the calibration point checking is enabled. If the calibration point checking is disabled, the device will send a \$C8 for OK byte to the TS driver regardless of where the touch was detected. This calibration point checking can be enabled or disabled by sending a command byte of \$A5 to the device. When all the calibration points are done, the device will do a self-test and send a command of \$CB for OK or a command of \$CC for failed. If a \$CC is received, the TS driver should issue a warning stating the calibration was not done properly and redo the calibration procedures. The flowchart for the calibration procedures is shown in Figure 8.

14.0 Calibration (Continued)

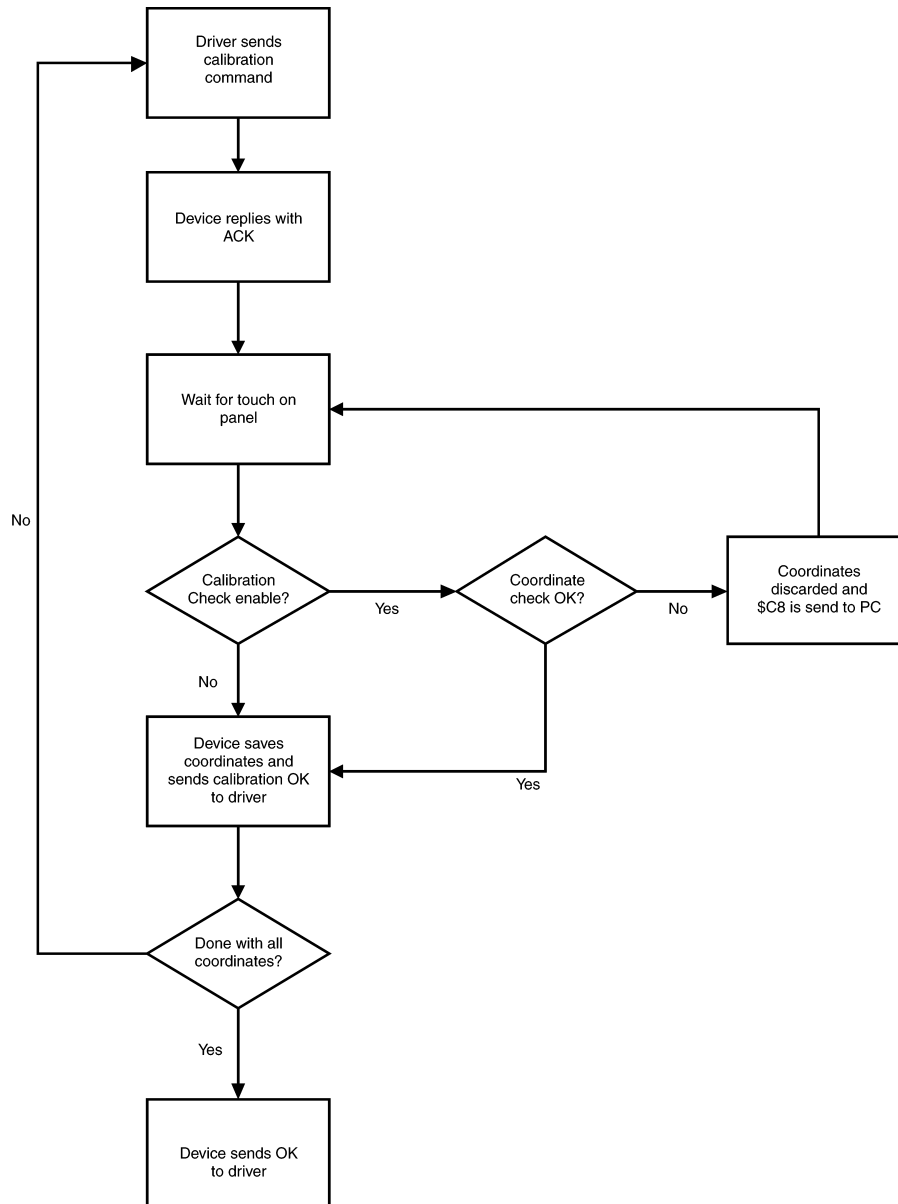

20037210

FIGURE 8. Calibration Procedures with Coordinates Checking Enabled

14.2 CALIBRATION PROCEDURES WITH COORDINATES CHECKING ENABLED

To do TS calibration with coordinates checking enabled, first ensure the Calibration Coordinates Checking is enabled on the device. This can be accomplished by sending a command byte of \$B1 (Read Parameters command) and checking the 5th bit of the 12th reply byte is set. Alternatively, if the device is set to Calibration Coordinates Checking enabled as default, this step can be skipped.

The TS driver sends the command byte to do calibration (\$BD). The TS driver should wait for the reply bytes and ensure it is the same command bytes it sent. The device waits for a touch to be detected on the panel. Once a touch is detected, the device checks it against the predetermined

calibration values as noted on *Table 3. Two Points Calibration*, *Table 4. Five Points Calibration*, and *Table 5. Thirteen Points Calibration*. If the detected touch is within the predefined value (± 127 of the raw A/D value), the device will send a command of \$C4 to the TS driver and store the calibration point in the internal flash. The TS driver can now send a command byte to do the next calibration point. If the detected touch is not within the predefined value, the device will send a reply byte of \$C8 to the TS driver. Upon receiving this reply byte, the TS driver can resend the calibration command for the same calibration point, go the next calibration point, or abort the calibration process.

Once all the calibration points are done, the device does a self-test. If the self-test was not successful, the device will

14.0 Calibration (Continued)

send a reply byte of \$CC to the TS driver. At this point, the TS driver should either notify the user to redo the calibration point or automatically redo the calibration again. If the self-test was successful, the device will send a reply byte of \$CB to the TS driver.

14.3 CALIBRATION PROCEDURES WITH COORDINATES CHECKING DISABLED

To do TS calibration with coordinates checking disabled, first ensure the Calibration Coordinates Checking is disabled on the device. This can be accomplished by sending a command byte of \$B1 (Read Parameters command) and checking the 5th bit of the 12th reply byte is not set. Alternatively, if the device is set to Calibration Coordinates Checking disabled as default, this step can be skipped.

The TS driver sends the command byte to do calibration (\$BD). The TS driver should wait for the reply bytes and

ensure it is the same command bytes it sent. The device waits for a touch to be detected on the panel. Once a touch is detected, the device save the values into the internal flash and send a reply byte of \$C4 to the TS driver. The TS driver can now send a command byte to do the next calibration point. Since the Calibration Checking is disabled, the TS driver should ensure the calibration point is within the range of the calibration cross.

Once all the calibration points are done, the device does a self-test. If the self-test was not successful, the device will send a reply byte of \$CC to the TS driver. At this point, the TS driver should either notify the user to redo the calibration point or automatically redo the calibration again. If the self-test was successful, the device will send a reply byte of \$CB to the TS driver.

15.0 Revision History

Date	Section	Summary of Changes
October 2002		Initial release.
May 2003	All sections	Removed LM8400 part.
	Brownout Reset	Updated section to reflect the change and made external reset circuitry optional.
July 2003	Advanced Command Bytes	Added command byte \$A5
	Descriptions	Updated controller reply bytes
December 2003	Advanced Command Bytes	Added description for command byte \$A5
	Descriptions	

16.0 Physical Dimensions inches (millimeters) unless otherwise noted

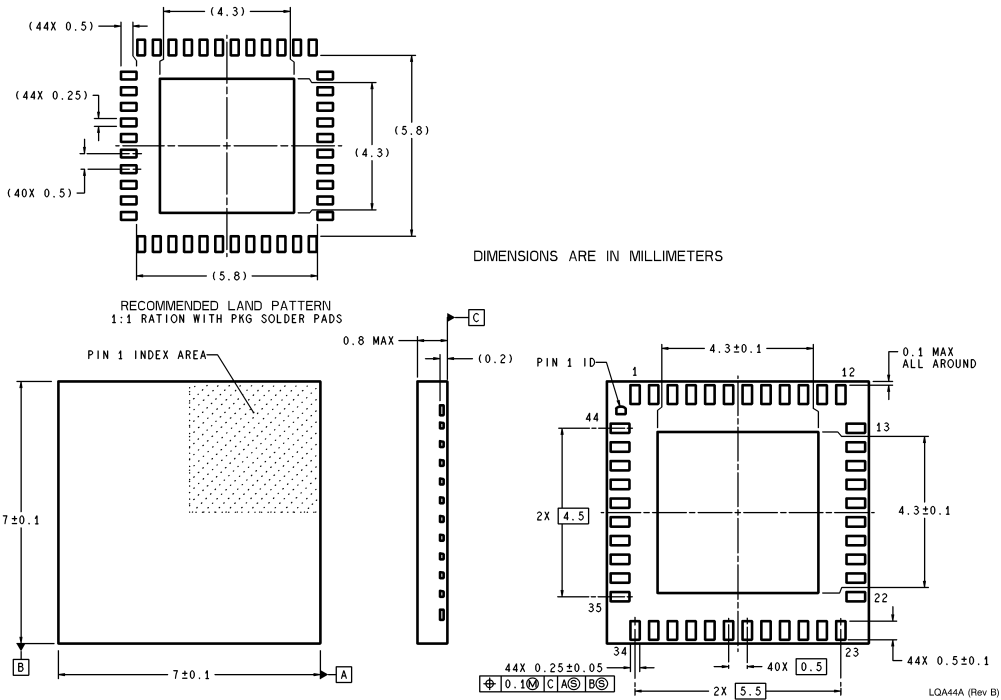

LLP Package (LQA)
Order Number LM8300HLQ9 or LM8500HLQ9
NS Package Number LQA44A

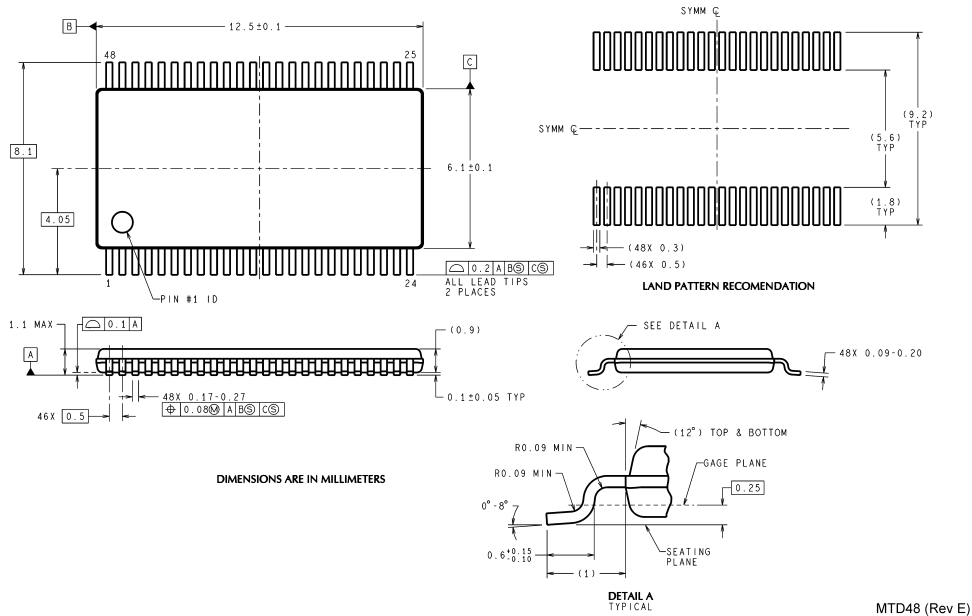

TSSOP Package (MTD)
Order Number LM8300IMT9 or LM85009IMT9
NS Package Number MTD48

16.0 Physical Dimensions inches (millimeters) unless otherwise noted (Continued)

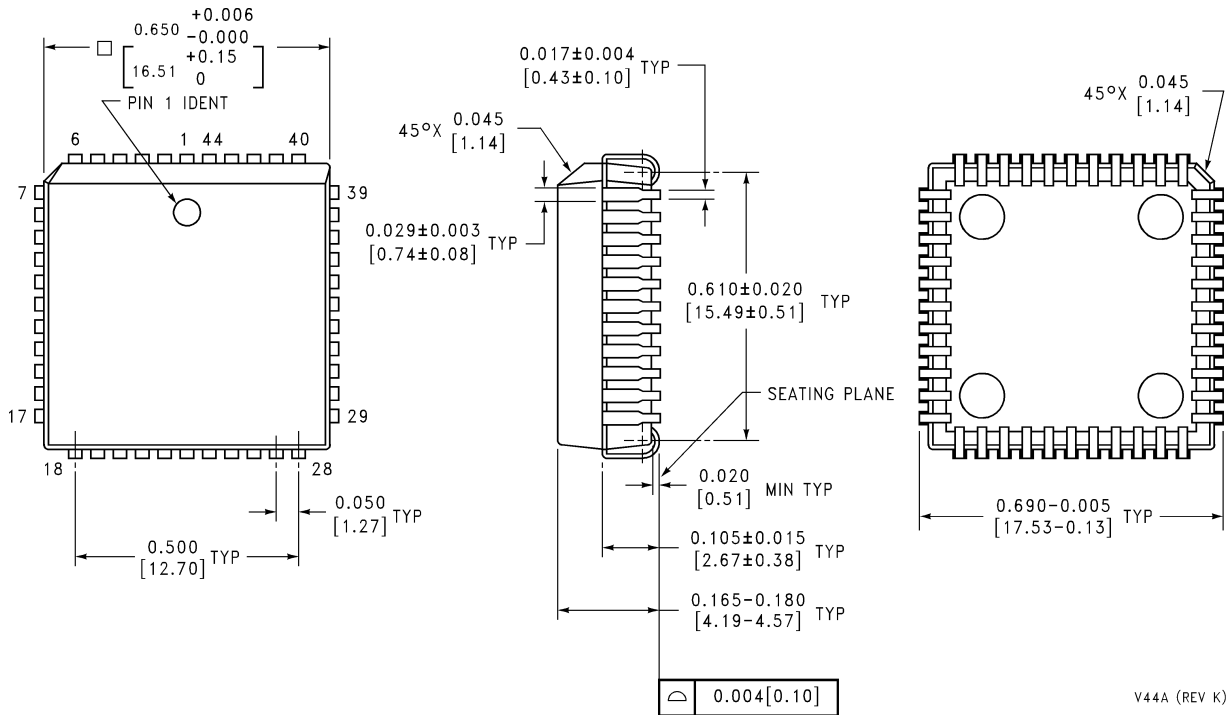

Plastic Leaded Chip Carrier (VA)
Order Number LM8300HVA9 or LM8500HVA9
NS Package Number V44A

V44A (REV K)

LIFE SUPPORT POLICY

NATIONAL'S PRODUCTS ARE NOT AUTHORIZED FOR USE AS CRITICAL COMPONENTS IN LIFE SUPPORT DEVICES OR SYSTEMS WITHOUT THE EXPRESS WRITTEN APPROVAL OF THE PRESIDENT AND GENERAL COUNSEL OF NATIONAL SEMICONDUCTOR CORPORATION. As used herein:

1. Life support devices or systems are devices or systems which, (a) are intended for surgical implant into the body, or (b) support or sustain life, and whose failure to perform when properly used in accordance with instructions for use provided in the labeling, can be reasonably expected to result in a significant injury to the user.
2. A critical component is any component of a life support device or system whose failure to perform can be reasonably expected to cause the failure of the life support device or system, or to affect its safety or effectiveness.

BANNED SUBSTANCE COMPLIANCE

National Semiconductor certifies that the products and packing materials meet the provisions of the Customer Products Stewardship Specification (CSP-9-111C2) and the Banned Substances and Materials of Interest Specification (CSP-9-111S2) and contain no "Banned Substances" as defined in CSP-9-111S2.



National Semiconductor
Americas Customer
Support Center
 Email: new.feedback@nsc.com
 Tel: 1-800-272-9959

www.national.com

National Semiconductor
Europe Customer Support Center
 Fax: +49 (0) 180-530 85 86
 Email: europa.support@nsc.com
 Deutsch Tel: +49 (0) 69 9508 6208
 English Tel: +44 (0) 870 24 0 2171
 Français Tel: +33 (0) 1 41 91 8790

National Semiconductor
Asia Pacific Customer
Support Center
 Email: ap.support@nsc.com

National Semiconductor
Japan Customer Support Center
 Fax: 81-3-5639-7507
 Email: jpn.feedback@nsc.com
 Tel: 81-3-5639-7560