

100mA Low Dropout Voltage Regulators

FEATURES

- 5.0V and 3.3V Versions at 100mA Output
- Very Low Quiescent Current
- Low Dropout Voltage: 380mV at 100mA
- Extremely Tight Load and Line Regulation
- Very Low Temperature Coefficient
- Current & Thermal Limiting
- Need Only 1 μ F for Stability
- Offered in Lead Free, RoHS Compliant Packages:
TO-92 (LP2950) & SOIC (LP2951)
- Direct Replacement For LP2950/LP2951

LP2951 versions only

- Error Flag Warns of Output Dropout
- Logic-Controlled Electronic Shutdown
- Output Programmable From 1.24 to 29V

APPLICATIONS

- Battery Powered Systems
- Cordless Telephones
- Radio Control Systems
- Portable/Palm Top/Notebook Computers
- Portable Consumer Equipment
- Portable Instrumentation
- Avionics
- SMPS Post-Regulator
- Voltage Reference
- Automotive Electronics

Now Available in Lead Free Packaging

PRODUCT DESCRIPTION

The LP2950 and LP2951 are low power voltage regulators. These devices are an excellent choice for use in battery-powered applications such as cordless telephones, radio control systems, and portable computers. The LP2950 and LP2951 feature low quiescent current and low dropout voltage (typ. 50mV at light load and 380 mV at 100mA). This includes a tight initial tolerance (0.5% typ.), extremely good load and line regulation (0.05% typ.), and very low output temperature coefficient (20 ppm/°C typ.), making the LP2950/LP2951 useful as a low-power voltage reference.

The error flag output feature is used as a power-on reset for warning of a low output voltage, due to a falling input voltage. The logic-compatible shutdown feature enables the regulator to be switched ON and OFF. The LP2950 is offered in a 3-pin TO-92 package compatible with other 5V, 3.3V regulators. The LP2951 is available in an 8-lead SOIC package.

Block diagram of LP2951

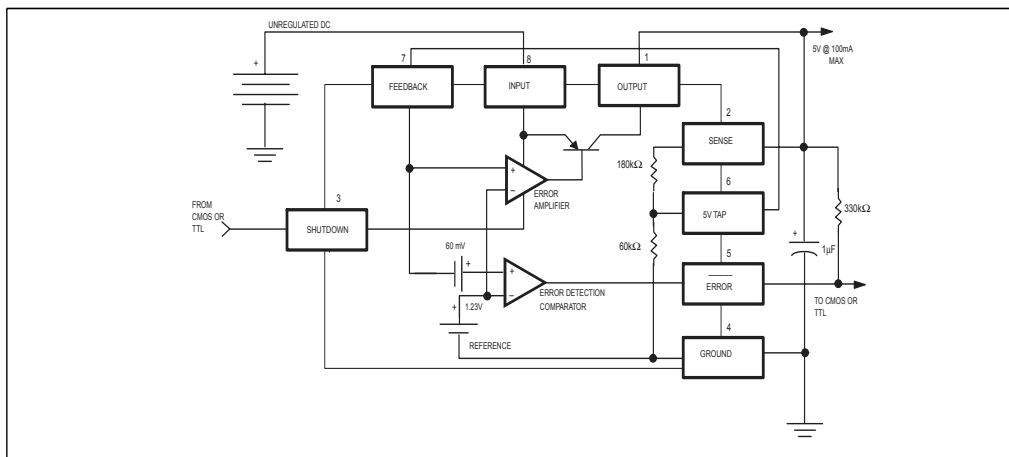

ABSOLUTE MAXIMUM RATINGS

Power Dissipation.....Internally Limited	Feedback Input Voltage.....-1.5V to +30V
Lead Temp. (Soldering, 5 Seconds).....260°C	Shutdown Input Voltage.....-0.3V to +30V
Storage Temperature Range.....-65° to +150°C	Error Comparator Output.....-0.3V to +30V
Operating Junction Temperature Range -40C to +125C	ESD Rating2kV Min
Input Supply Voltage.....-0.3V to +30V	

ELECTRICAL CHARACTERISTICS $V_{IN}=6V$, $I_O=100\mu A$, $C_{OUT}=1\mu F$ (Note 2) $T_A=25^\circ C$, unless otherwise noted

PARAMETER	CONDITIONS	LP2950AC LP2951AC			LP2950C LP2951C			UNITS
		Min.	Typ.	Max.	Min.	Typ.	Max.	
3.3 V Versions								
Output Voltage	$T_J = 25^\circ C$	3.284	3.3	3.317	3.267	3.3	3.333	V
	$-25^\circ C \leq T_J \leq 85^\circ C$	3.267	3.3	3.333	3.251	3.3	3.350	
	Full Operating Temperature	3.260	3.3	3.340	3.234	3.3	3.366	
Output Voltage	$100\mu A \leq I_L \leq 100\text{ mA}$ $T_J \leq T_{MAX}$	3.254	3.3	3.346	3.221	3.3	3.379	V
5 V Versions								
Output Voltage	$T_J = 25^\circ C$	4.975	5.0	5.025	4.950	5.0	5.050	V
	$-25^\circ C \leq T_J \leq 85^\circ C$	4.950	5.0	5.050	4.925	5.0	5.075	
	Full Operating Temperature	4.940	5.0	5.060	4.900	5.0	5.100	
Output Voltage	$100\mu A \leq I_L \leq 100\text{ mA}$ $T_J \leq T_{MAX}$	4.925	5.0	5.075	4.880	5.0	5.120	V
All Voltage Options								
Output Voltage Temperature Coefficient	(Note 1)		20	120		50	150	ppm/°C
Line Regulation (Note 3)	$6V \leq V_{IN} \leq 30V$ (Note 4)		0.03	0.1		0.04	0.2	%
Load Regulation (Note 3)	$100\mu A \leq I_L \leq 100\text{ mA}$		0.04	0.1		0.1	0.2	%
Dropout Voltage (Note 5)	$I_L = 100\mu A$		50	80		50	80	mV
	$I_L = 100\text{ mA}$		380	450		380	450	mV
Ground Current	$I_L = 100\mu A$		150	170		150	170	μA
	$I_L = 100\text{ mA}$		8	12		8	12	mA
Current Limit	$V_{OUT} = 0$		150	200		150	200	mA
Thermal Regulation			0.05	0.2		0.05	0.2	%/W
Output Noise, 10Hz to 100KHz	$C_L = 1\mu F$		430			430		μV rms
	$C_L = 200\mu F$		160			160		μV rms
	$C_L = 3.3\mu F$, Bypass = 0.01 μF from Pin 7 to Pin 1 (LP2951)		100			100		μV rms
8-Pin Versions only		LP2951AC			LP2951C			
Reference Voltage		1.220	1.235	1.250	1.210	1.235	1.260	V
Reference Voltage	Over Temperature (Note 6)	1.190		1.270	1.185		1.285	V
Feedback Pin Bias Current			40	60		40	60	nA

PARAMETER	CONDITIONS (Note 2)	LP2951AC			LP2951C			UNITS
		Min.	Typ.	Max.	Min.	Typ.	Max.	
8-Pin Versions only (Continued)								
Reference Voltage Temperature Coefficient			20			50		ppm/°C
Feedback Pin Bias Current Temperature Coefficient			0.1			0.1		nA/°C
Error Comparator								
Output Leakage Current	V _{OH} = 30V		0.01	1		0.01	1	μA
Output Low Voltage	V _{IN} = 4.5V I _{OL} = 400 μA		150	250		150	250	mV
Upper Threshold Voltage	(Note 7)		40	60		40	60	mV
Lower Threshold Voltage	(Note 7)		75	95		75	95	mV
Hysteresis	(Note 7)		15			15		mV
Shutdown Input								
Input logic Voltage	Low (Regulator ON) High (Regulator OFF)	2.0	1.3	0.7	2.0	1.3	0.7	V V
Shut down Pin Input Current	V _S = 2.4V V _S = 30V		30 675	50 800		30 675	50 800	μA μA
Regulator Output Current in Shutdown	(Note 8)		3	10		3	10	μA
Thermal Resistance θ _{JA}	8 Pin SOIC		128.4					°C/W
	3 Pin TO-92		131.9					°C/W

Note 1: Output or reference voltage temperature coefficients defined as the worst case voltage change divided by the total temperature range.

Note 2: Unless otherwise specified all limits guaranteed for T_J = 25°C, V_{IN} = 6V, I_L = 100 μA and C_L = 1μF. Additional conditions for the 8-pin versions are feedback tied to 5V tap and output tied to output sense (V_{OUT} = 5V) and V_{SHUTDOWN} ≤ 0.8V.

Note 3: Regulation is measured at constant junction temperature, using pulse testing with a low duty cycle. Changes in output voltage due to heating effects are covered under the specification for thermal regulation.

Note 4: Line regulation for the LP2951 is tested at I_L = 1mA. For I_L = 100 μA and T_J = 125°C, line regulation is guaranteed by design to 0.2%. See typical performance characteristics for line regulation versus temperature and load current.

Note 5: Dropout voltage is defined as the input to output differential at which the output voltage drops 100 mV below its nominal value measured at 1V differential. At very low values of programmed output voltage, the minimum input supply voltage of 2V (2.3V over temperature) must be taken into account.

Note 6: V_{REF} ≤ V_{OUT} ≤ (V_{IN} - 1V), 2.3 ≤ V_{IN} ≤ 30V, 100μA ≤ I_L ≤ 100mA, T_J ≤ T_{JMAX}.

Note 7: Comparator thresholds are expressed in terms of a voltage differential at the feedback terminal below the nominal reference voltage measured at 6V input. To express these thresholds in terms of output voltage change, multiply by the error amplifier gain = V_{OUT}/V_{REF} = (R₁ + R₂)/R₂. For example, at a programmed output voltage of 5V, the error output is guaranteed to go low when the output drops by 95 mV x 5V/1.235 = 384 mV. Thresholds remain constant as a percent of V_{OUT} as V_{OUT} is varied, with the dropout warning occurring at typically 5% below nominal, 7.5% guaranteed.

Note 8: V_{SHUTDOWN} ≥ 2V, V_{IN} ≤ 30V, V_{OUT} = 0, Feedback pin tied to 5V Tap.

Note 9: All typical values are not guaranteed. The value could vary from lot to lot.

TYPICAL PERFORMANCE CHARACTERISTIC

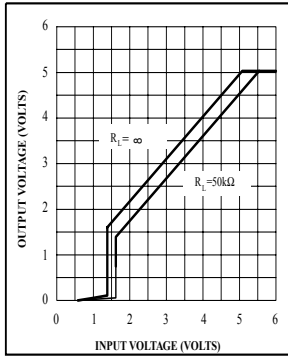

Dropout Characteristics

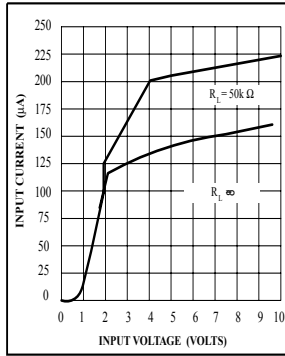

Input Current

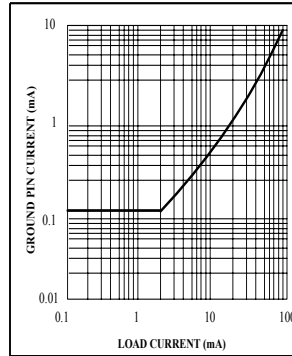

Quiescent Current

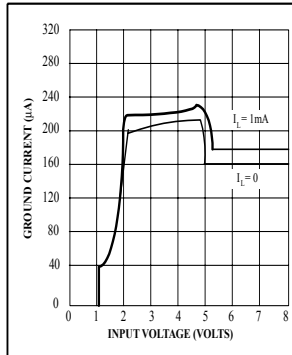

Ground Current

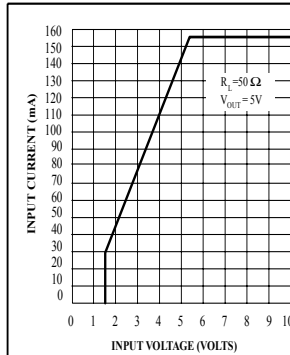

Input Current

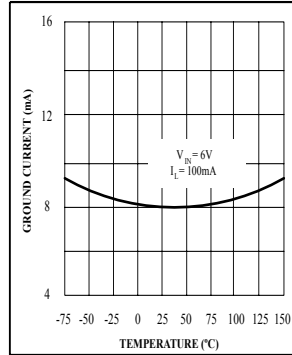

Ground Current

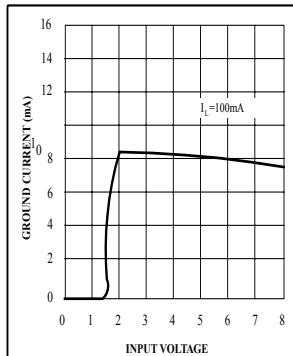

Ground Current

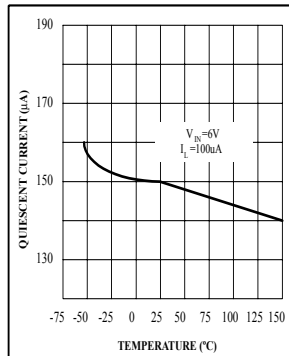

Quiescent Current

TYPICAL PERFORMANCE CHARACTERISTICS (continued)

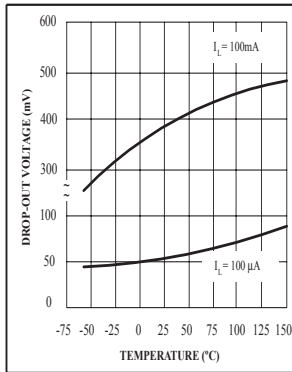

Drop-Out Voltage

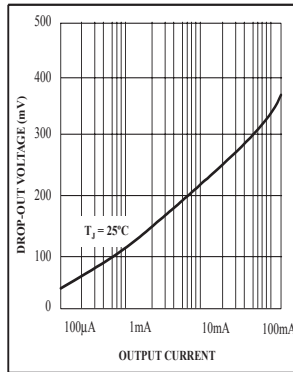

Drop-Out Voltage

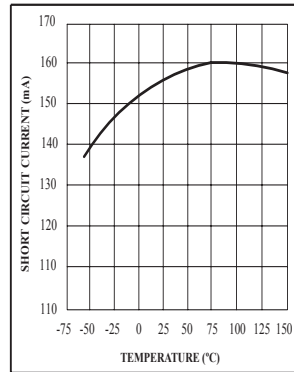

Short Circuit Current

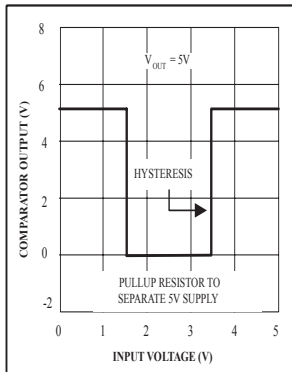

Error Comparator Output

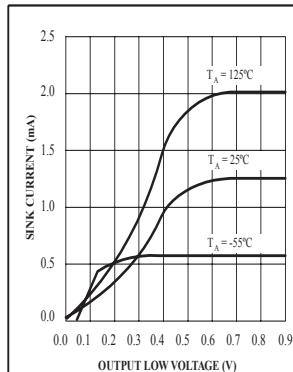

LP2951 Comparator Sink Current

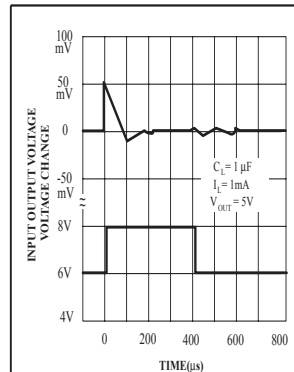

Line Transient Response

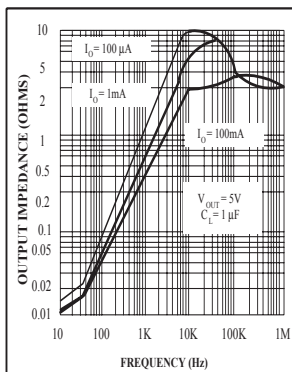

Output Impedance

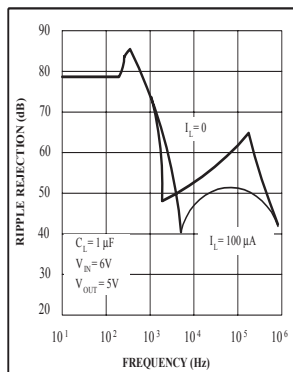

Ripple Rejection

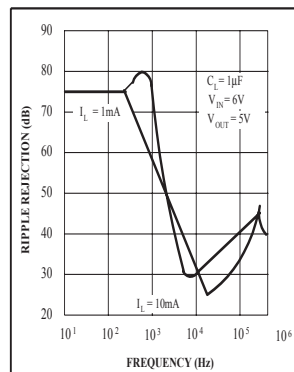

Ripple Rejection

TYPICAL PERFORMANCE CHARACTERISTICS (continued)

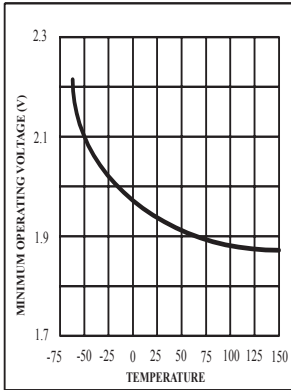

LP2951 Minimum Operating Voltage

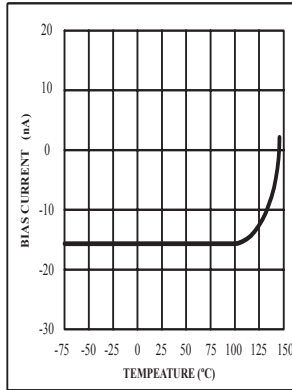

LP2951 Feedback Bias Current

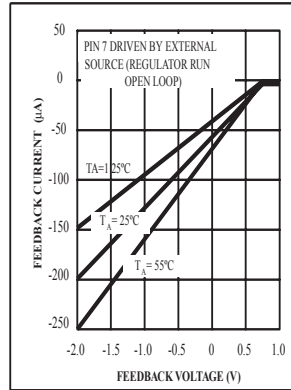

LP2951 Feedback Pin Current

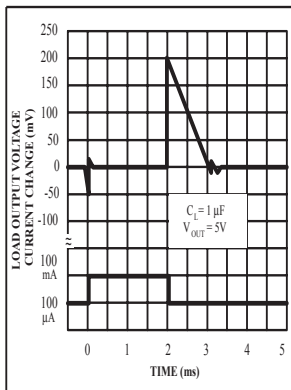

Load Transient Response

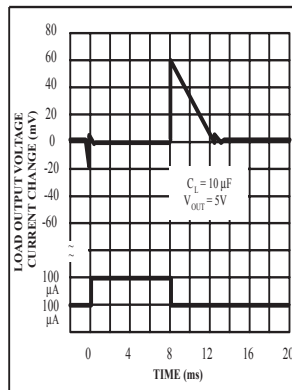

Load Transient Response

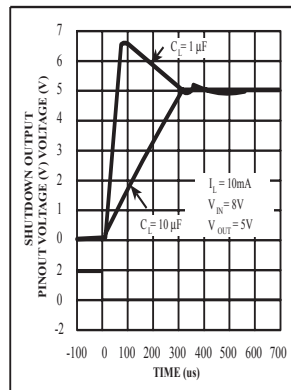

Enable Transient

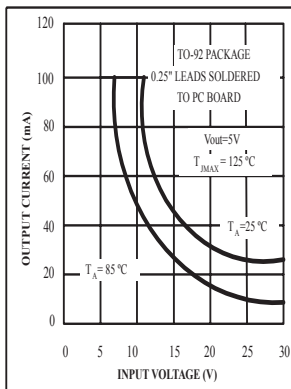

LP2950 Maximum Rated Output

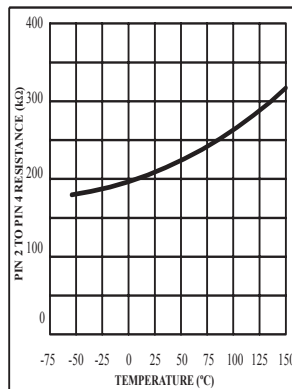

LP2951 Divider Resistance

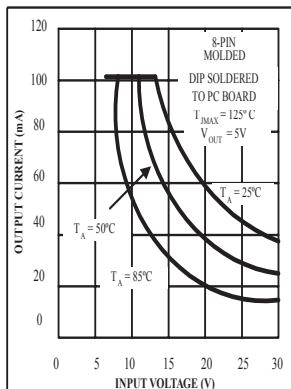

LP2950 Maximum Rated Output Current

TYPICAL APPLICATIONS

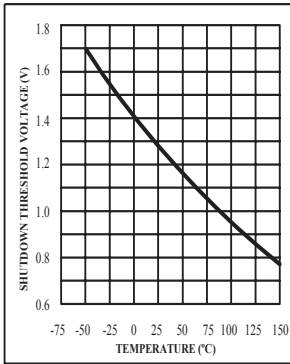

Shutdown Threshold Voltage

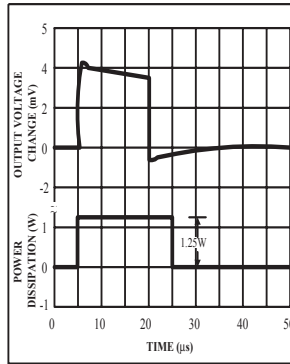

Thermal Response

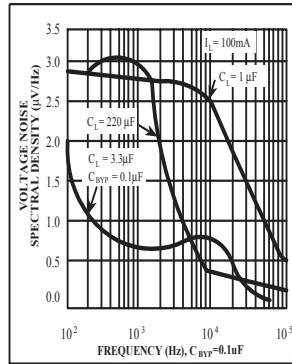

Output Noise

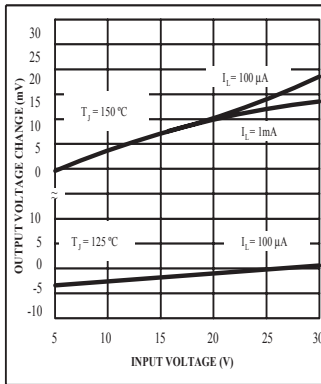

Line Regulation

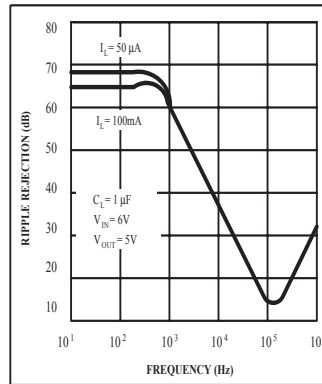

Ripple Rejection

APPLICATION HINTS EXTERNAL CAPACITORS

The stability of the LP2950/LP2951 requires a 1.0 μ F or greater capacitor between output and ground. Oscillation could occur without this capacitor. Most types of tantalum or aluminum electrolytic works fine here. For operations below -25°C solid tantalum is recommended since the many aluminum types have electrolytes that freeze at about -30°C. The ESR of about 5 Ω or less and resonant frequency above 500kHz are the most important parameters in the value of the capacitor. The capacitors value may be increased without limit.

At lower values of output current, less output capacitance is required for stability. For the currents below 10mA the value of the capacitor can be reduced to 0.33 μ F and 0.1 μ F for 1mA. More output capacitance is needed for the 8-pin version at voltages below 5V since it runs the error amplifier at lower gain. At worst case 3.3 μ F or greater must be used for the condition of 100mA load at 1.23V output.

The LP2950/51 unlike other low dropout regulators will remain stable and in regulation with no load in addition to the internal voltage divider. This feature is especially important in applications like CMOS RAM keep-alive. When setting the output voltage of the LP2950/51 version with external resistors, a minimum load of 1 μ A is recommended

If there is more than 10 inches of wire between the input and the AC filter capacitor or if a battery is used as the input then a 1 μ A tantalum or aluminum electrolytic capacitor should be placed from the input to the ground.

Instability can occur if there is stray capacitance to the LP2951 feedback terminal (pin 7). This could cause more problems when using a higher value of external resistors to set the output voltage. This problem can be fixed by adding a 100pF capacitor between output and feedback and increasing the output capacitor to at least 3.3 μ F.

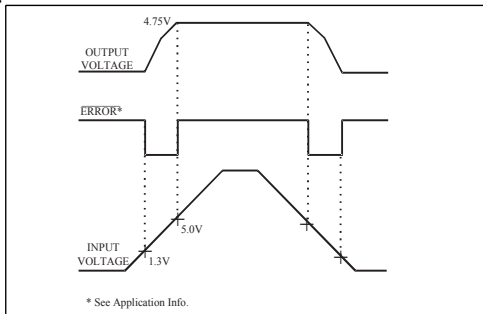

Figure 1. ERROR Output Timing

ERROR DETECTION COMPARATOR OUTPUT

The Comparator produces a logic low output whenever the LP2951 output falls out of regulation by more than around 5%. This is around 60 mV offset divided by the 1.235 reference voltage. This trip level

remains 5% below normal regardless of the programmed output voltage of the regulator.

Figure 1 shows the timing diagram depicting the ERROR signal and the regulator output voltage as the LP2951 input is ramped up and down. The ERROR signal becomes low at around 1.3V input, and goes high around 5V input (input voltage at which $V_{OUT} = 4.75$).

Since the LP2951's dropout voltage is load dependent, the input voltage trip point (around 5V) will vary with the load current. The output voltage trip point (approx. 4.75V) does not vary with load.

The error comparator has an open-collector output, which requires an external pull-up resistor. Depending on the system requirements the resistor may be returned to 5V output or other supply voltage. In determining the value of this resistor, note that the output is rated to sink 400 μ A, this value adds to battery drain in a low battery condition. Suggested values range from 100K to 1M Ω . If the output is unused this resistor is not required.

PROGRAMMING THE OUTPUT VOLTAGE OF LP2951

The LP2951 may be pin-strapped for 5V using its internal voltage divider by tying Pin 1 (output) to Pin 2 (sense) and Pin 7 (feedback) to Pin 6 (5V Tap). Also, it may be programmed for any output voltage between its 1.235V reference and its 29V maximum rating. As seen in Figure 2, an external pair of resistors is required. Refer to the below equation for the programming of the output voltage:

$$V_{OUT} = V_{REF} \times (1 + R_1/R_2) + I_{FB}R_1$$

The V_{REF} is 1.235 and I_{FB} is the feedback bias current, nominally -20nA. The minimum recommended load current of 1 μ A forces an upper limit of 1.2M Ω on value of R_2 . If no load is presented the I_{FB} produces an error of typically 2% in V_{OUT} which may be eliminated at room temperature by trimming R_1 . To improve the accuracy choose the value of $R_2 = 100k$ this reduces the error by 0.17% and increases the resistor program current by 12 μ A. Since the LP2951 typically draws 60 μ A at no load with Pin 2 open-circuited this is a small price to pay

REDUCING OUTPUT NOISE

It may be an advantage to reduce the AC noise present at the output. One way is to reduce the regulator bandwidth by increasing the size of the output capacitor. This is the only way that noise can be reduced on the 3 lead LP2950 but is relatively inefficient, as increasing the capacitor from 1 μ F to 220 μ F only decreases the noise from 430 μ V to 160 μ V $_{RMS}$ for a 100kHz bandwidth at 5V output. Noise could also be reduced fourfold by a bypass capacitor across R_1 , since it reduces the high frequency gain from 4 to unity. Pick

$$C_{BYPASS} \cong 1 / 2 \pi R_1 \times 200 \text{ Hz}$$

or choose 0.01 μ F. When doing this, the output capacitor must be increased to 3.3 μ F to maintain stability. These changes reduce the output noise from 430 μ V to 100 μ V $_{RMS}$ for a 100kHz bandwidth at 5V output. With the bypass capacitor added, noise no longer scales with output voltage so that improvements are more dramatic at higher output voltages.

TYPICAL APPLICATIONS

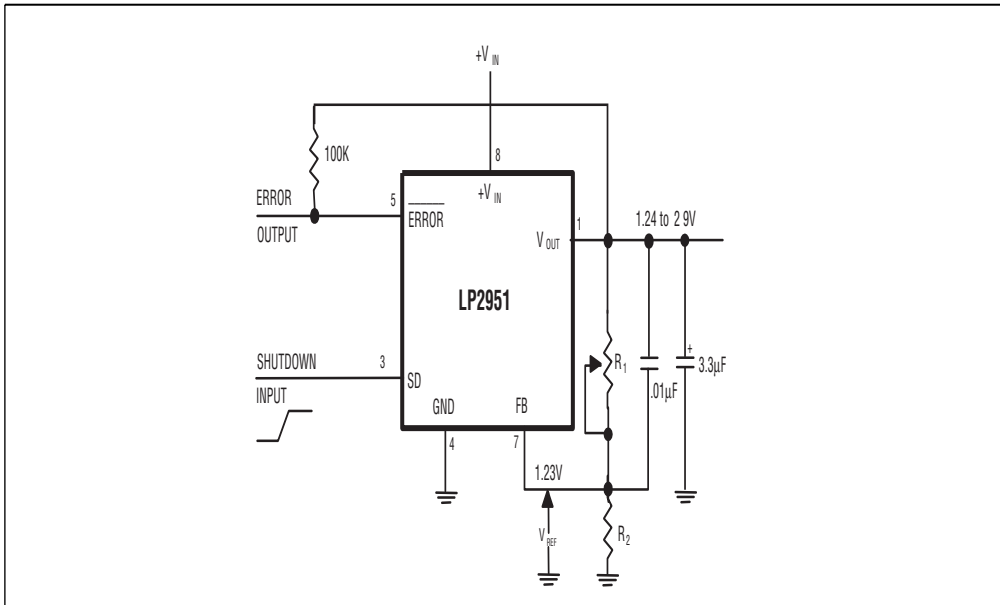

Figure 2. Adjustable Regulator

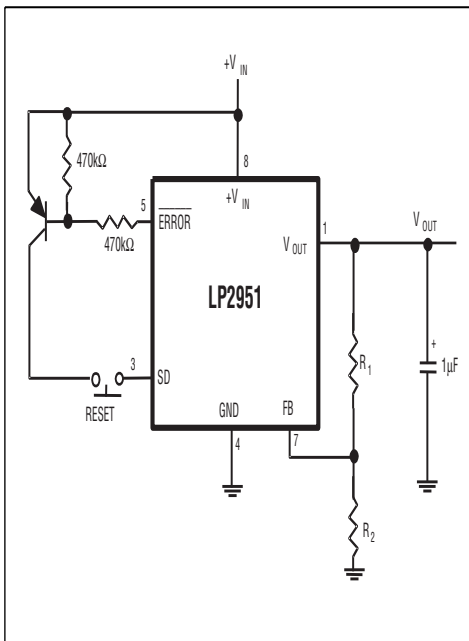

Figure 3. Latch Off When Error Flag Occurs

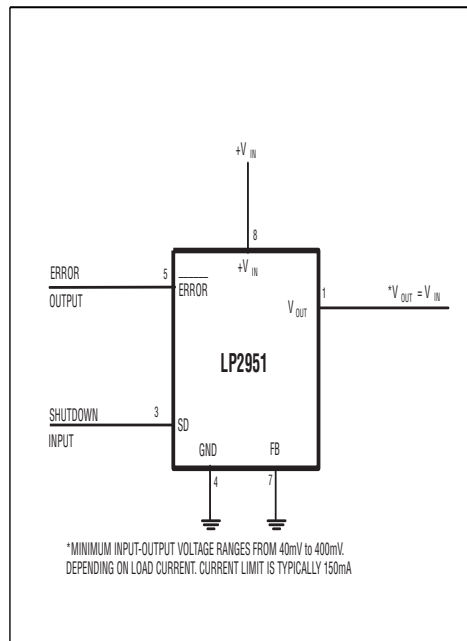

Figure 4. Wide Input Voltage Range Current Limiter

TYPICAL APPLICATIONS (continued)

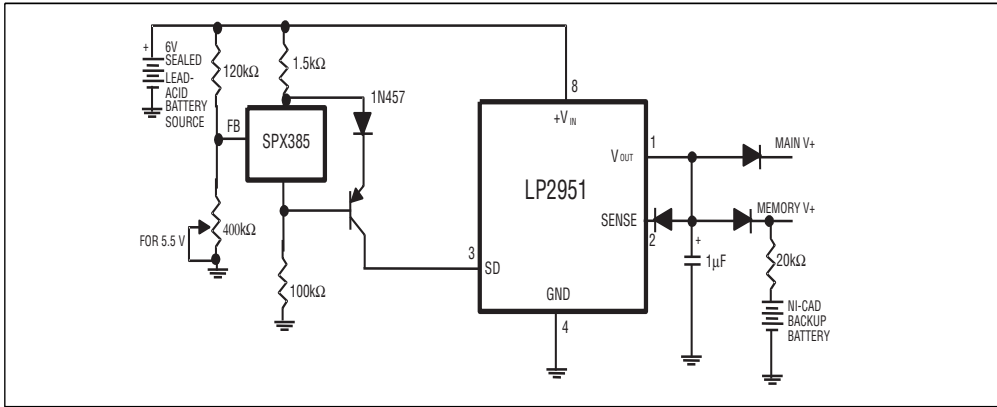

Figure 5. Low Battery disconnect

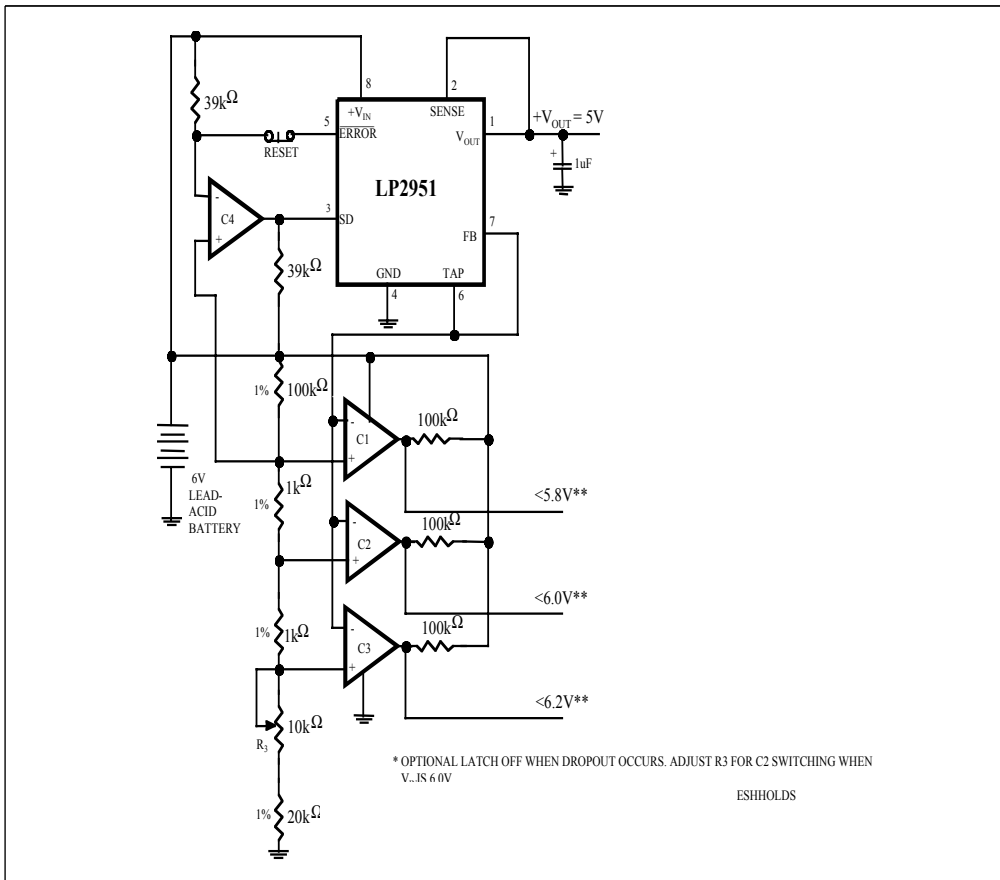
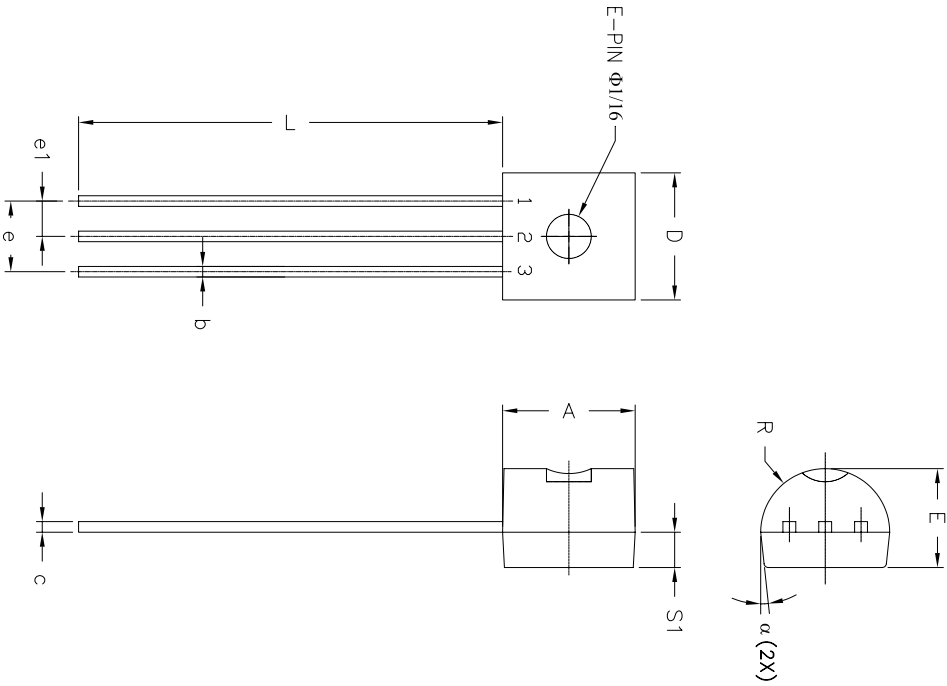

Figure 6. Regulator with State-of-Charge Indicator



3 Pin TO-92 JEDEC TO-226-AA					
SYMBOLS	DIMENSIONS IN INCH (Control Unit)		DIMENSIONS IN MM (Reference Unit)		
	MIN	MAX	MIN	MAX	
A	0.170	0.210	4.32	5.33	
b	0.014	0.020	0.36	0.51	
c	0.016	0.022	0.41	0.55	
D	0.175	0.205	4.45	5.20	
E	0.125	0.165	3.18	4.19	
e	0.095	0.105	2.42	2.66	
e1	0.045	0.055	1.15	1.39	
L	0.500	0.610	12.70	15.49	
R	0.045	0.095	2.16	2.41	
S1	0.045	0.060	1.14	1.52	
alpha	4°	6°	4°	6°	
N	3	3	3	3	

REVISION HISTORY			
REV.	DESCRIPTION	DATE	APP'D
A	DRAWING ORIGINATOR	09/23/05	JL
B	DRAWING FORMAT MODIFICATION	08/15/06	JL

		SIPLEX CORPORATION		
				Packaging Approval:
By: JL	Date: 08/15/06	Drawing No: 3-PIN TO-92 PACKAGE OUTLINE	Revision: B	Sheet: 1 OF 1

REVISION HISTORY			
REV	DISCRPTION	DATE	APP'D
A	DRAWING ORIGINATION	08/16/05	JL
B	DRAWING FORMAT MODIFICATION	07/19/06	JL

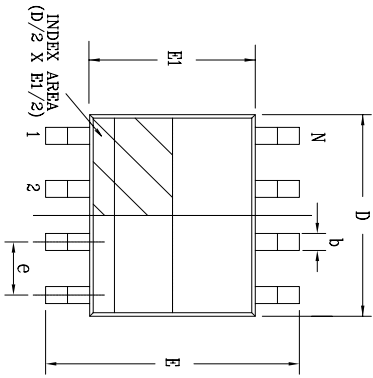

Top View

8 Pin SOICN		JEDEC MS-012 Variation AA				
SYMBOLS	DIMENSIONS IN MM (Control Unit)			DIMENSIONS IN INCH (Reference Unit)		
	MIN	NOM	MAX	MIN	NOM	MAX
A	1.35	—	1.75	0.053	—	0.069
A1	0.10	—	0.25	0.004	—	0.010
A2	1.25	—	1.65	0.049	—	0.065
b	0.31	—	0.51	0.012	—	0.020
c	0.17	—	0.25	0.007	—	0.010
E	6.00 BSC	—	—	0.236 BSC	—	—
E1	3.90 BSC	—	—	0.154 BSC	—	—
e	1.27 BSC	—	—	0.050 BSC	—	—
h	0.25	—	0.50	0.010	—	0.020
L	0.40	—	1.27	0.016	—	0.050
L1	1.04 REF	—	—	0.041 REF	—	—
L2	0.25 BSC	—	—	0.010 BSC	—	—
R	0.07	—	—	0.003	—	—
R1	0.07	—	—	0.003	—	—
θ	0°	—	8°	0°	—	8°
θ1	5°	—	15°	5°	—	15°
θ2	0°	—	—	0°	—	—
D	4.90 BSC	—	—	0.193 BSC	—	—
N	8	—	—	8	—	—

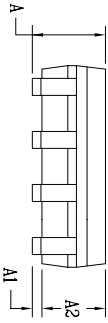

Side View

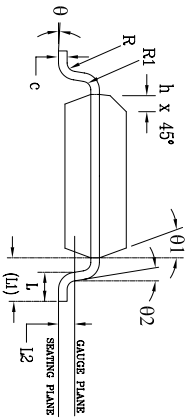

Front View

		SIPLEX CORPORATION	
		8 PIN SOICN PACKAGE OUTLINE	
Packaging Approval:	Date: 07/19/06	Drawing No.:	Revision: B
By: JL	8-PIN SOICN	Sheet:	1 OF 1

Part Number	Accuracy	Output Voltage	Package	Shipping	Status
LP2950ACN-L-3-3	0.50%	3.3V	Lead Free 3 Pin TO-92	Bulk	Active
LP2950ACN-L-3-3/TR	0.50%	3.3V	Lead Free 3 Pin TO-92	Tape & Reel	Active
LP2950ACN-L-5-0	0.50%	5.0V	Lead Free 3 Pin TO-92	Bulk	Active
LP2950ACN-L-5-0/TR	0.50%	5.0V	Lead Free 3 Pin TO-92	Tape & Reel	Active
LP2950CN-L-3-3	1%	3.3V	Lead Free 3 Pin TO-92	Bulk	Active
LP2950CN-L-3-3/TR	1%	3.3V	Lead Free 3 Pin TO-92	Tape & Reel	Active
LP2950CN-L-5-0	1%	5.0V	Lead Free 3 Pin TO-92	Bulk	Active
LP2950CN-L-5-0/TR	1%	5.0V	Lead Free 3 Pin TO-92	Tape & Reel	Active
LP2951ACS-L-3-3	0.50%	3.3V	Lead Free 8 Pin SOIC	Bulk	Active
LP2951ACS-L-3-3/TR	0.50%	3.3V	Lead Free 8 Pin SOIC	Tape & Reel	Active
LP2951ACS-L-5-0	0.50%	5.0V/ADJ	Lead Free 8 Pin SOIC	Bulk	Active
LP2951ACS-L-5-0/TR	0.50%	5.0V/ADJ	Lead Free 8 Pin SOIC	Tape & Reel	Active
LP2951CS-L-3-3	1%	3.3V	Lead Free 8 Pin SOIC	Bulk	Active
LP2951CS-L-3-3/TR	1%	3.3V	Lead Free 8 Pin SOIC	Tape & Reel	Active
LP2951CS-L-5-0	1%	5.0V/ADJ	Lead Free 8 Pin SOIC	Bulk	Active
LP2951CS-L-5-0/TR	1%	5.0V/ADJ	Lead Free 8 Pin SOIC	Tape & Reel	Active



Sipex Corporation

Headquarters and
Sales Office

233 South Hillview Drive
Milpitas, CA 95035
TEL: (408) 934-7500
FAX: (408) 935-7600

Sipex Corporation reserves the right to make changes to any products described herein. Sipex does not assume any liability arising out of the application or use of any product or circuit described herein; neither does it convey any license under its patent rights nor the rights of others.

Part Number	Accuracy	Output Voltage	Package	Shipping	Status
LP2950ACN-3-3	0.50%	3.3V	3 Pin TO-92	Bulk	EOL
LP2950ACN-5-0	0.50%	5.0V	3 Pin TO-92	Bulk	EOL
LP2950CN-3-3	1%	3.3V	3 Pin TO-92	Bulk	EOL
LP2950CN-3-3/TR	1%	3.3V	3 Pin TO-92	Tape & Reel	EOL
LP2950CN-5-0	1%	5.0V	3 Pin TO-92	Bulk	EOL
LP2950CN-5-0/TR	1%	5.0V	3 Pin TO-92	Tape & Reel	EOL
LP2951ACS-3-3	0.50%	3.3V	8 Pin SOIC	Bulk	EOL
LP2951ACS-5-0	0.50%	5.0V/ADJ	8 Pin SOIC	Bulk	EOL
LP2951CS-3-3	1%	3.3V	8 Pin SOIC	Bulk	EOL
LP2951CS-3-3/TR	1%	3.3V	8 Pin SOIC	Tape & Reel	EOL
LP2951CS-5-0	1%	5.0V/ADJ	8 Pin SOIC	Bulk	EOL
LP2951CS-5-0/TR	1%	5.0V/ADJ	8 Pin SOIC	Tape & Reel	EOL
LP2950ACN-3-3/TR	0.50%	3.3V	3 Pin TO-92	Tape & Reel	OBS
LP2950ACN-5-0/TR	0.50%	5.0V	3 Pin TO-92	Tape & Reel	OBS
LP2951ACS-3-3/TR	0.50%	3.3V	8 Pin SOIC	Tape & Reel	OBS
LP2951ACS-5-0/TR	0.50%	5.0V/ADJ	8 Pin SOIC	Tape & Reel	OBS



Sipex Corporation

**Headquarters and
Sales Office**
233 South Hillview Drive
Milpitas, CA 95035
TEL: (408) 934-7500
FAX: (408) 935-7600

Sipex Corporation reserves the right to make changes to any products described herein. Sipex does not assume any liability arising out of the application or use of any product or circuit described herein; neither does it convey any license under its patent rights nor the rights of others.