

SCM 4CO P**Weidmüller Interface GmbH & Co. KG**

Klingenbergstraße 26

D-32758 Detmold

Germany

www.weidmueller.com

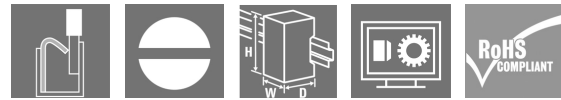
Product image

Relay sockets for the D-SERIES DRM relays

- 2 and 4 CO contacts
- Screw and PUSH IN connection
- Standard and low heights

General ordering data

Version	D-SERIES DRM, Relay socket, Number of contacts: 4, CO contact, Continuous current: 6 A, PUSH IN
Order No.	7760056363
Type	SCM 4CO P
GTIN (EAN)	6944169772276
Qty.	10 pc(s).

Creation date January 12, 2024 8:38:37 PM CET

Catalogue status 09.12.2023 / We reserve the right to make technical changes.

SCM 4CO P

Weidmüller Interface GmbH & Co. KG

Klingenbergstraße 26

D-32758 Detmold

Germany

www.weidmueller.com

Technical data

Dimensions and weights

Depth	42.7 mm	Depth (inches)	1.681 inch
Height	101.8 mm	Height (inches)	4.008 inch
Width	30.6 mm	Width (inches)	1.205 inch
Net weight	71.12 g		

Temperatures

Storage temperature	-40 °C...85 °C	Operating temperature	-40 °C...55 °C
Humidity	5...85 %, no condensation		

Rated data UL

Certificate No. (cURus)	E355547
-------------------------	---------

Load side

Rated switching voltage	250 V AC	Continuous current	6 A
Max. switching voltage, AC	250 V	Contact type	4 CO contact

General data

Rail	TS 35		
Colour	black		
UL94 flammability rating component	Component	Retaining clip	
	UL94 flammability rating	HB	
	Component	Mounting foot	
	UL94 flammability rating	HB	
	Component	Pusher	
	UL94 flammability rating	HB	
Component	Housing		
	UL94 flammability rating		V-2

Insulation coordination

Rated voltage	250 V	Pollution severity	2
Surge voltage category	III	Insulating material group	IIIb
Clearance and creepage distances for control side - load side	≥ 3 mm	Dielectric strength for control side - load side	4 kV _{eff} / 1 min
Dielectric strength of neighbouring contacts	2.5 kV _{eff} / 1 Min.	Dielectric strength of open contact	2.5 kV _{eff} / 1 Min.
Impulse withstand voltage at neighbouring contacts	4.8 kV (1.2/50 µs)	Protection degree	IP20

Further details of approvals / standards

Certificate No. (cURus)	E355547
-------------------------	---------

SCM 4CO P

Weidmüller Interface GmbH & Co. KG

Klingenbergstraße 26

D-32758 Detmold

Germany

www.weidmueller.com

Technical data

Connection data

Wire connection method	PUSH IN	Stripping length, rated connection	10 mm
Clamping range, rated connection	1.5 mm ²	Clamping range, min.	0.14 mm ²
Clamping range, max.	1.5 mm ²	Wire connection cross section AWG, min.	AWG 26
Wire connection cross section AWG, max.	AWG 16	Wire cross-section, solid, min.	0.14 mm ²
Wire cross-section, solid, max.	1.5 mm ²	Wire connection cross section, finely stranded, min.	0.14 mm ²
Wire connection cross section, finely stranded, max.	1.5 mm ²	Wire connection cross-section, finely stranded with wire-end ferrules DIN 46228/4, min.	0.14 mm ²
Wire connection cross-section, finely stranded with wire-end ferrules DIN 46228/4, max.	1 mm ²	Conductor cross-section, flexible, AEH (DIN 46228-1), min.	0.14 mm ²
Conductor cross-section, flexible, AEH (DIN 46228-1), max.	1.5 mm ²	Blade size	0.4 x 2.5 mm

Classifications

ETIM 6.0	EC001456	ETIM 7.0	EC001456
ETIM 8.0	EC001456	ETIM 9.0	EC001456
ECLASS 9.0	27-37-16-03	ECLASS 9.1	27-37-16-03
ECLASS 10.0	27-37-16-03	ECLASS 11.0	27-37-16-03
ECLASS 12.0	27-37-16-03	ECLASS 13.0	27371603

Important note

Product information Only connection A2 with the cross-connection SCM/SDI P CC (art. no. 7760056366) can be bridged on this socket.

Approvals

Approvals



ROHS	Conform
UL File Number Search	UL Website
Certificate No. (cURus)	E355547

Downloads

Approval/Certificate/Document of Conformity	EU Konformitätserklärung / EU Declaration of Conformity
Engineering Data	CAD data – STEP
Catalogues	Catalogues in PDF-format

SCM 4CO P

Weidmüller Interface GmbH & Co. KG
 Klingenbergstraße 26
 D-32758 Detmold
 Germany

www.weidmueller.com

Drawings

Wiring diagram

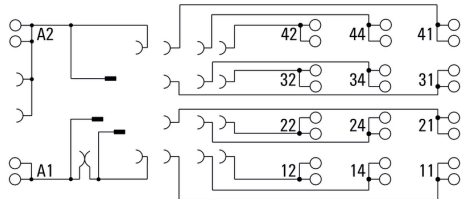

Dimensional drawing

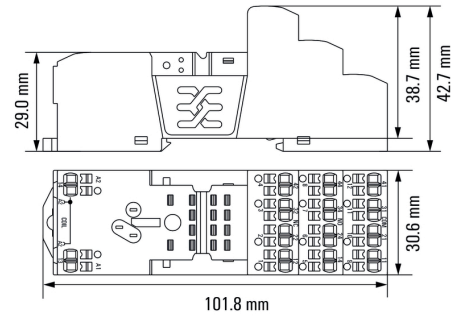

Example of use

How to install marker

on PUSH IN connection sockets (one slot available)

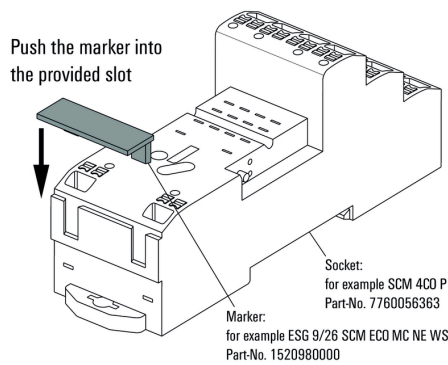



How to install marker

on PUSH IN connection sockets (one slot available)

Miscellaneous

Removal of cables

-  stranded with ferrule
-  stranded without ferrule
-  solid

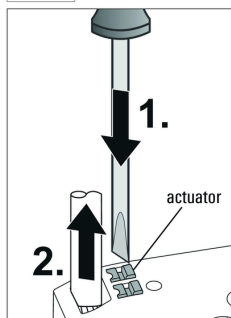

Wires will be disconnected just when opening the terminal with the actuator.

Miscellaneous

Insert flexible and solid cables

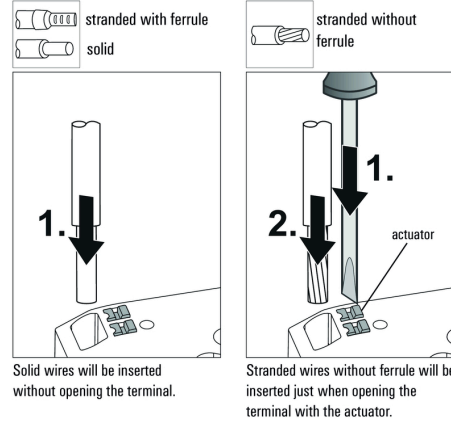

Solid wires will be inserted without opening the terminal.

Stranded wires without ferrule will be inserted just when opening the terminal with the actuator.

Miscellaneous

Recommended screwdriver

to push the actuator in PUSH IN

