



TAOGLAS®



Datasheet

Part No:
ADFGP.60A.01.0150D

Description:

Active All Band GNSS High Precision Antenna
with 150mm of RG-174 & SMA (M)

Features:

Embedded Dual Patch, Dual Feed 4-Pin Assembly
Covering all worldwide GNSS bands including the L-bands
Low Axial Ratio
Cable: 150mm of RG-174
Connector: SMA (M)
Dimensions: Ø80 x 19.1mm
RoHS & Reach Compliant

1. Introduction	3
2. Specifications	4
3. Antenna Characteristics	6
4. Radiation Patterns	12
5. LNA Characteristics	21
6. Mechanical Drawing	25
7. Packaging	26
8. Installation Recommendation	27
<hr/>	
Changelog	28

Taoglas makes no warranties based on the accuracy or completeness of the contents of this document and reserves the right to make changes to specifications and product descriptions at any time without notice. Taoglas reserves all rights to this document and the information contained herein. Reproduction, use or disclosure to third parties without express permission is strictly prohibited.



1. Introduction



The Taoglas ADFGP.60A.01.0150D is an innovative high performance, multi-band active, high precision GNSS antenna that has been carefully designed to provide fantastic positional accuracy on the full GNSS spectrum. It covers GPS/QZSS L1/L2/L5/L6, GLONASS G1/G2/G3, Galileo E1/E5a/E5b, BeiDou B1/B2a/B2b/B3, NAVIC L5, as well as SBAS (WAAS/EGNOS/GAGAN/SDCM/SNAS) and L-band corrections.

Correct implementation of the ADFGP.60A allows the user to achieve higher location accuracy, as well as stability of position tracking in urban environments. The novel Terrablast circular stacked patch construction has excellent performance across the full bandwidth of the antenna while reducing weight by nearly 40% compared to other antenna options. Its unique design provides excellent polarization and phase performance, providing exceptional positional and timing accuracy.

Typical applications that benefit from high precision capabilities include:

- Autonomous Driving
- Unmanned Aerial Vehicles
- Precision Positioning for Robotics
- Precision Agriculture
- Timing Accuracy Synchronization

The ADFGP.60A is the latest embedded addition to Taoglas' product portfolio of high precision GNSS antennas. When used on the base and/or the rover as part of an RTK configuration, the ADFGP.60A can achieve genuine cm-level accuracy with proven results.

Contact your regional Taoglas Customer Services team for more information or for support regarding integration.

2. Specifications

GNSS Frequency Bands Covered							
GPS/QZSS	L1	L2	L5	L6			
	1575.42MHz	1227.6MHz	1176.45MHz	1278.75MHz			
	■	■	■	■			
GLONASS	L5R	L3PT	L2PT	L1CR	L1PT		
	1176.45MHz	1201.5MHz	1246MHz	1575.42MHz	1602MHz		
	■	■	■	■	■		
Galileo	E5a	E5b	E4	E3	E6	E2	E1
	1176.45MHz	1201.5MHz	1215MHz	1256MHz	1278.75MHz	1561MHz	1575.42MHz
	■	■	■	■	■	■	■
BeiDou	B1	B2	B3				
	1561MHz	1207.14MHz	1268.52MHz				
	■	■	■				
Compass	E5B(B2)/ E6(B3)	E2(B1)					
	1268.56MHz	1561MHz					
	■	■					
SBAS	Omnistar	WAAS/EGN OS					
	1542.5MHz	1575.42MHz					
	■	■					

*SBAS systems: WASS(L1/L5), EGNOS(E1/E5a), SDCM(G1/G2/G3), SNAS(B1,B2a), GAGAN(L1/L5), QZSS(L1/L5), KAZZ(L1/L5).

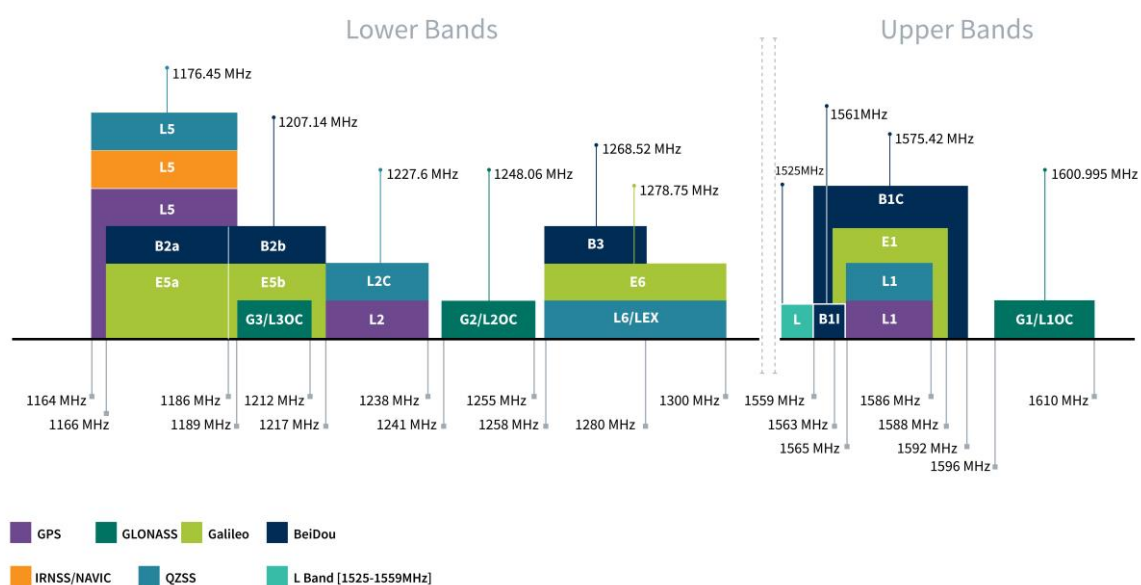

GNSS Bands and Constellations

GNSS Electrical						
Frequency (MHz)	1176.45	1227.6	1278	1561	1575.42	1602
VSWR (max.)	2.0:1	2.0:1	2.0:1	2.0:1	2.0:1	2.0:1
Efficiency (%) ¹	27%	45%	20%	18%	50%	45%
Peak Gain (dBi) ¹	1.3	1.8	-1.3	4.1	4.4	3.7
Axial Ratio (dB)	0.25	1.03	1.25	1.24	1.00	0.47
Group Delay Average (ns)	8.2	6.5	7.5	4.6	4.1	5.0
Group Delay Variation (ns) ²	6.5	6.2	6.4	3.4	4.1	1.9
PCO (cm)	0.6	1.0		0.7	0.7	0.8
PCV (cm)	0.6	0.4		0.3	0.7	0.6
Polarization	RHCP					
Impedance	50Ω					

Note 1: tested on a 150mm-diameter ground plane

Note 2: Maximum variation within the applicable band

LNA and Filter Electrical Properties						
Frequency (MHz)	1176.45	1227.6	1278	1561	1575.42	1602
Gain (dB) (Typ.)	26.3	27.0	24	25.3	25.1	24.6
Noise Figure (dB) (Typ.)	3.5	3.4	3.3	3.6	3.6	3.9
Current Draw (Typ.)	19 mA					
Supply Voltage	+2.0 ~ +5.5V					

Total Specification (Through Antenna, SAW Filter and LNA)						
Frequency (MHz)	1176.45	1227.6	1278	1561	1575.42	1602
Gain (dBi)	26	29.8	29.8	29.8	29.9	28.7
Output Impedance	50 Ω					

Mechanical	
Dimensions	Ø80mm x 19.1mm
Connector	SMA (M)
Cable	150mm RG-174
Weight	73g
Environmental	
Operation Temperature	-40°C to 85°C
Storage Temperature	-40°C to 85°C
Humidity	Non-condensing 65°C 95% RH

3. Antenna Characteristics

3.1 Return Loss

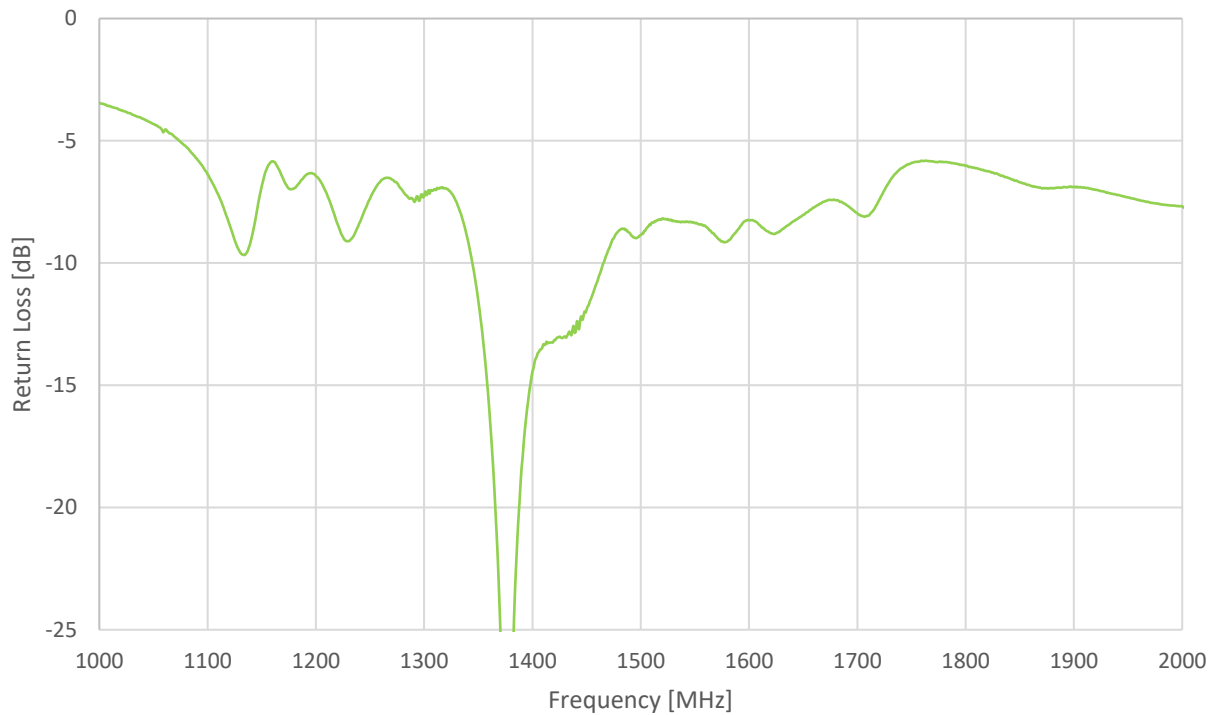

3.2 Efficiency (High Band)

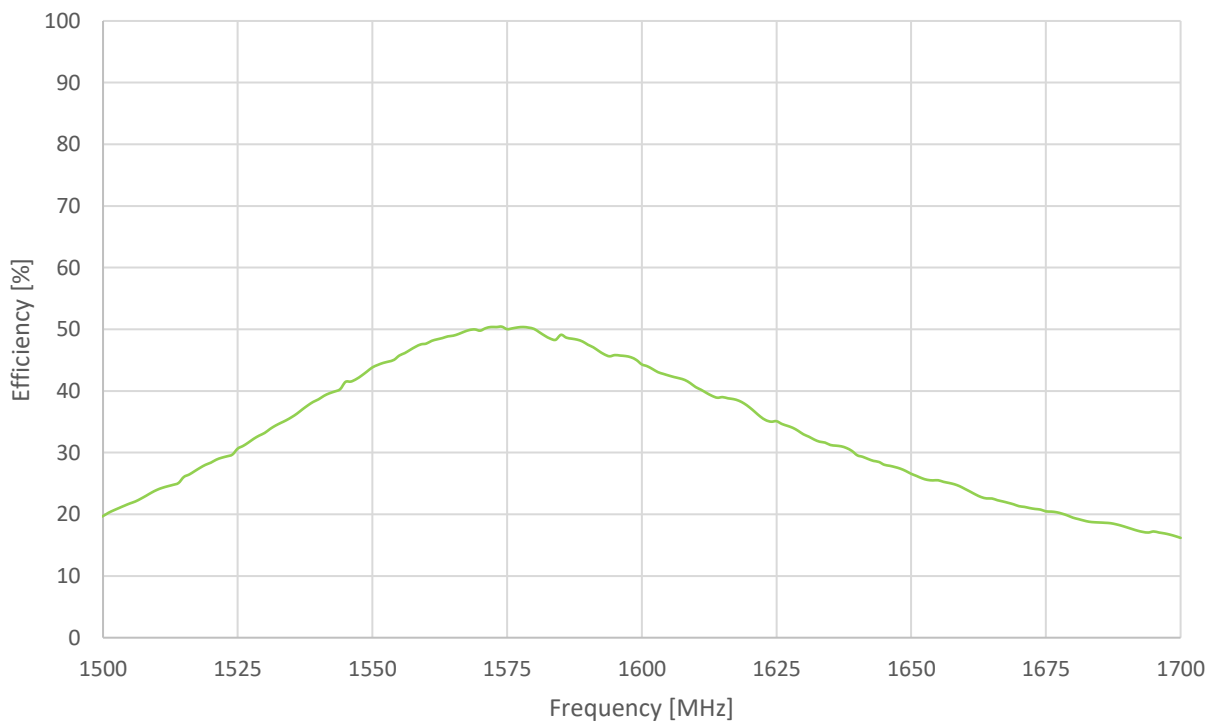

3.3 Average Gain (High Band)

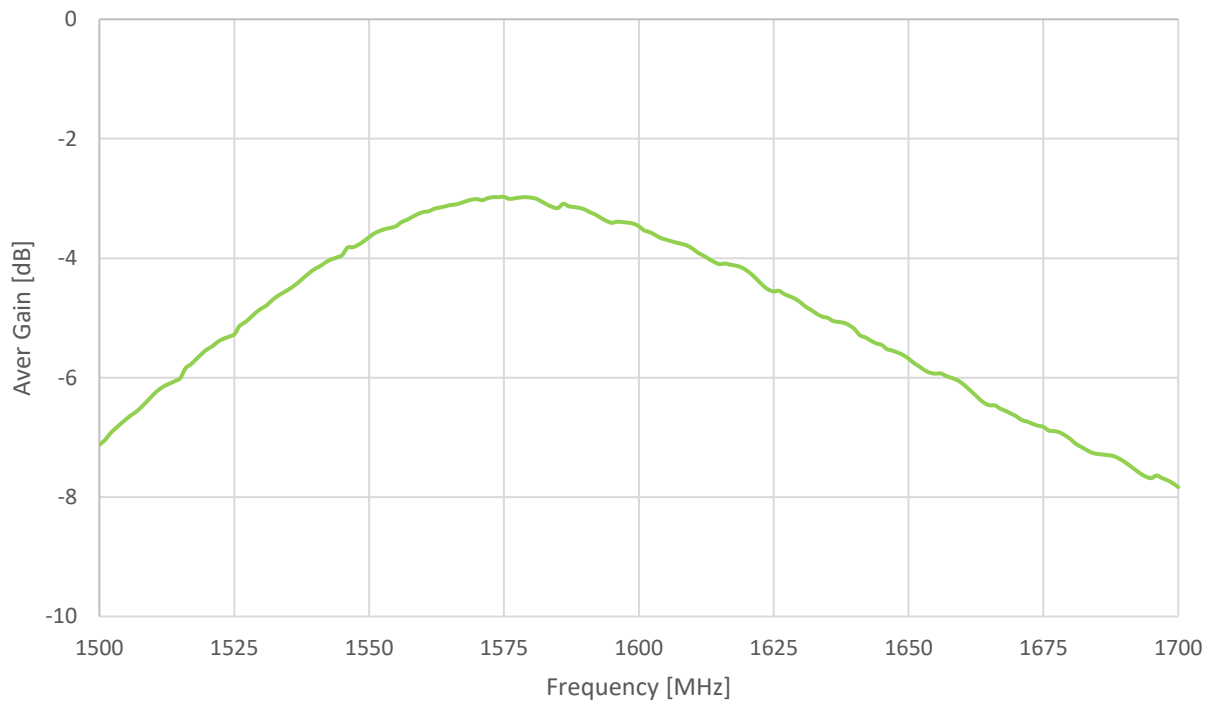

3.4 Peak Gain (High Band)

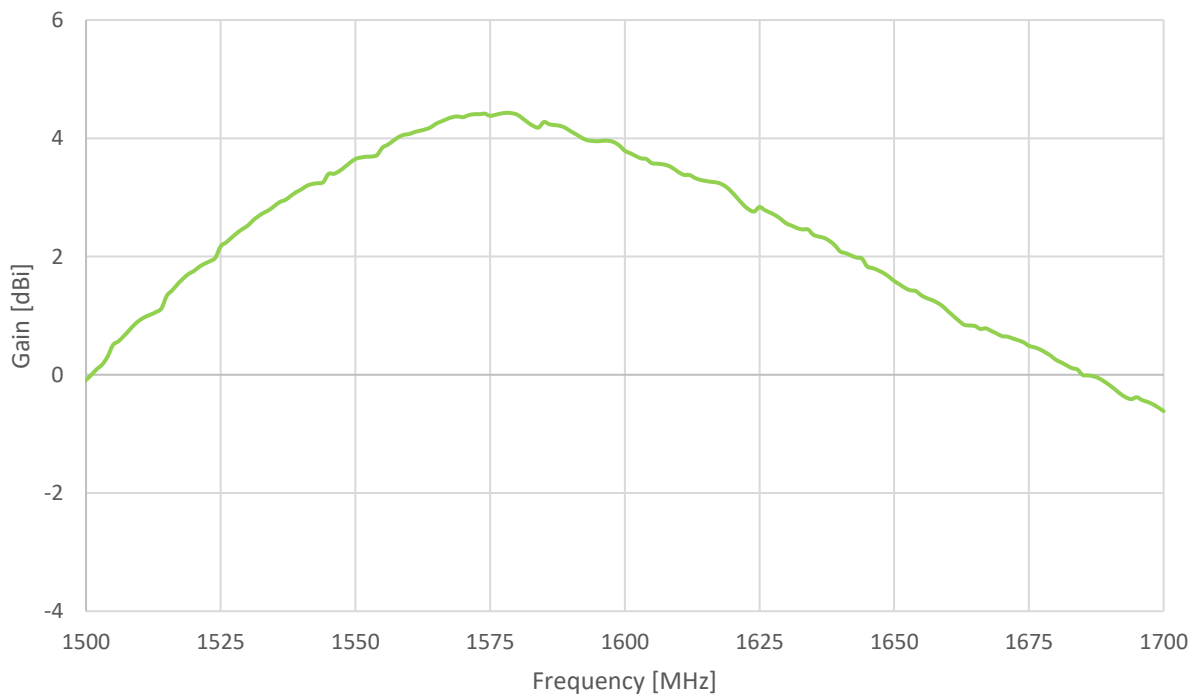

3.5 Efficiency (Low Band)

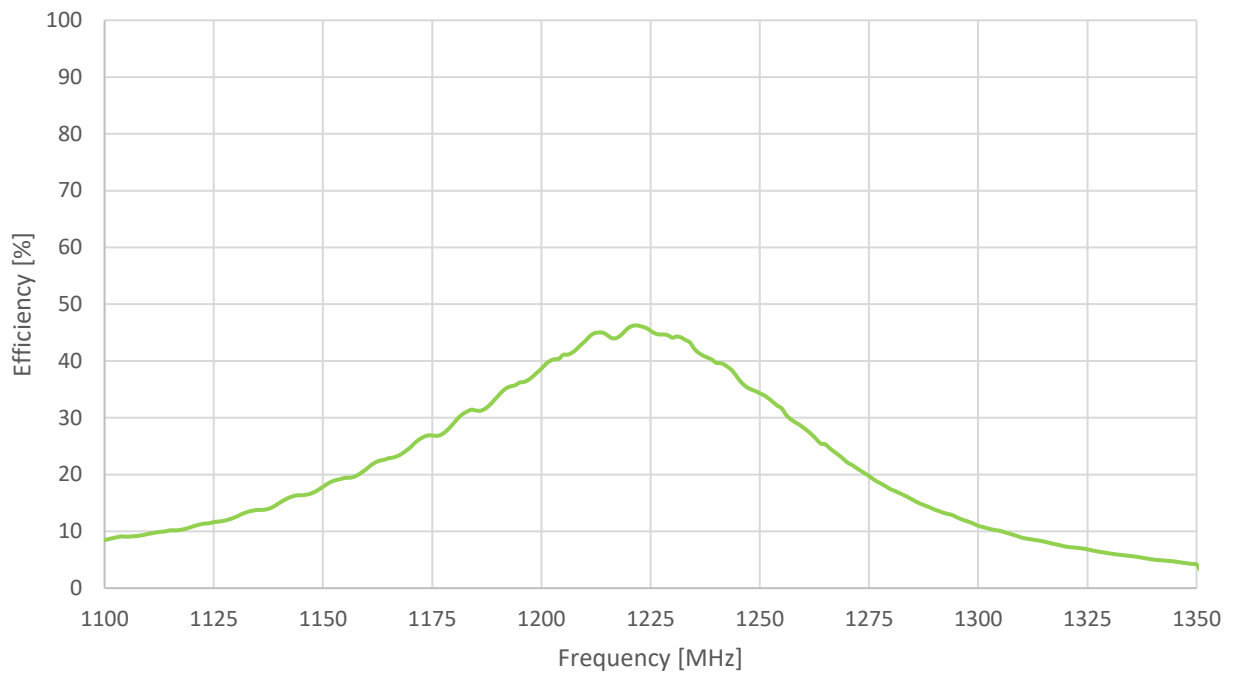

3.6 Average Gain (Low Band)

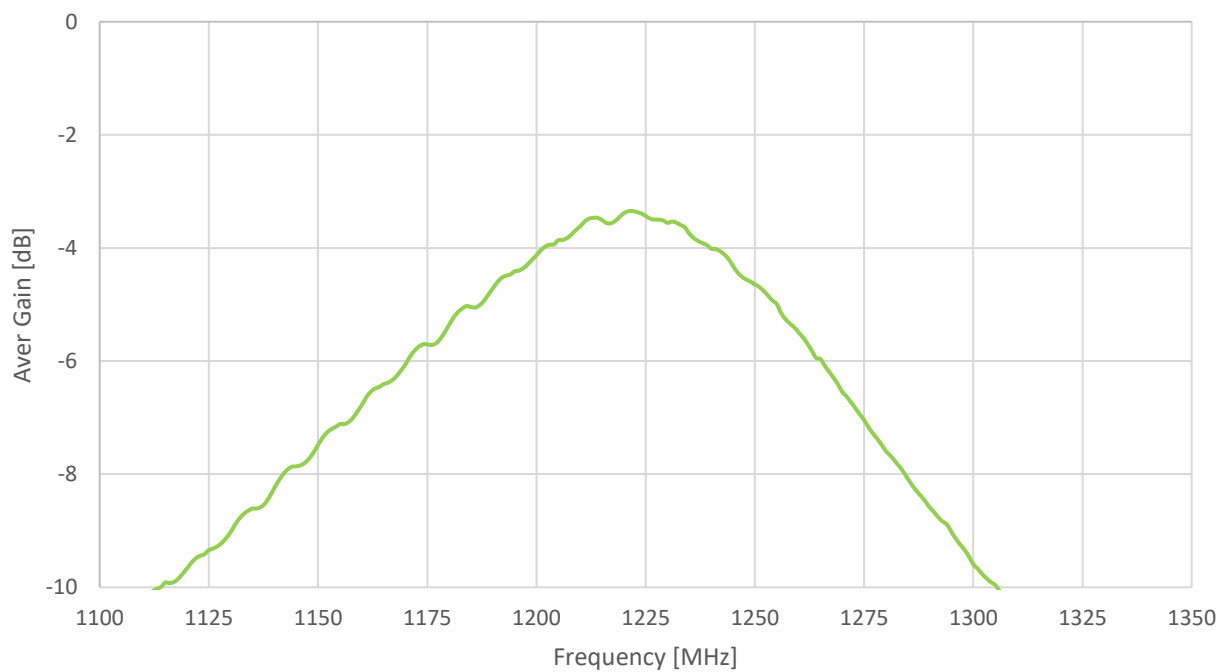

3.7 Peak Gain (Low Band)

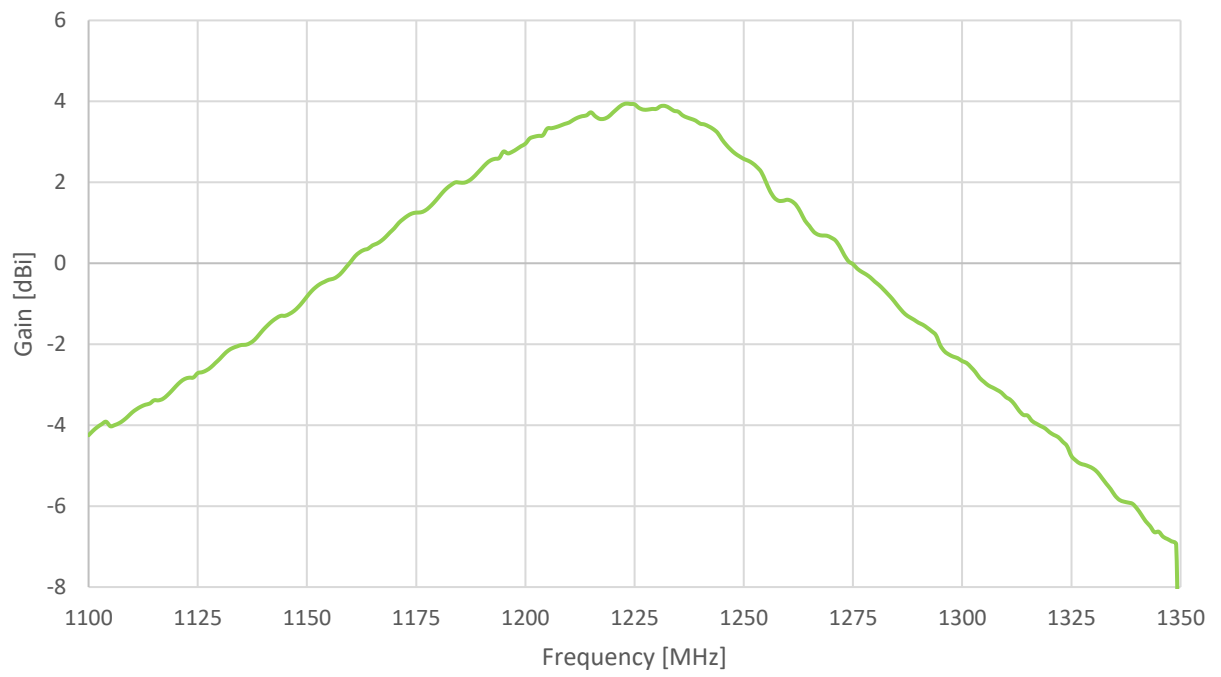

3.8 Axial Ratio (High Band)

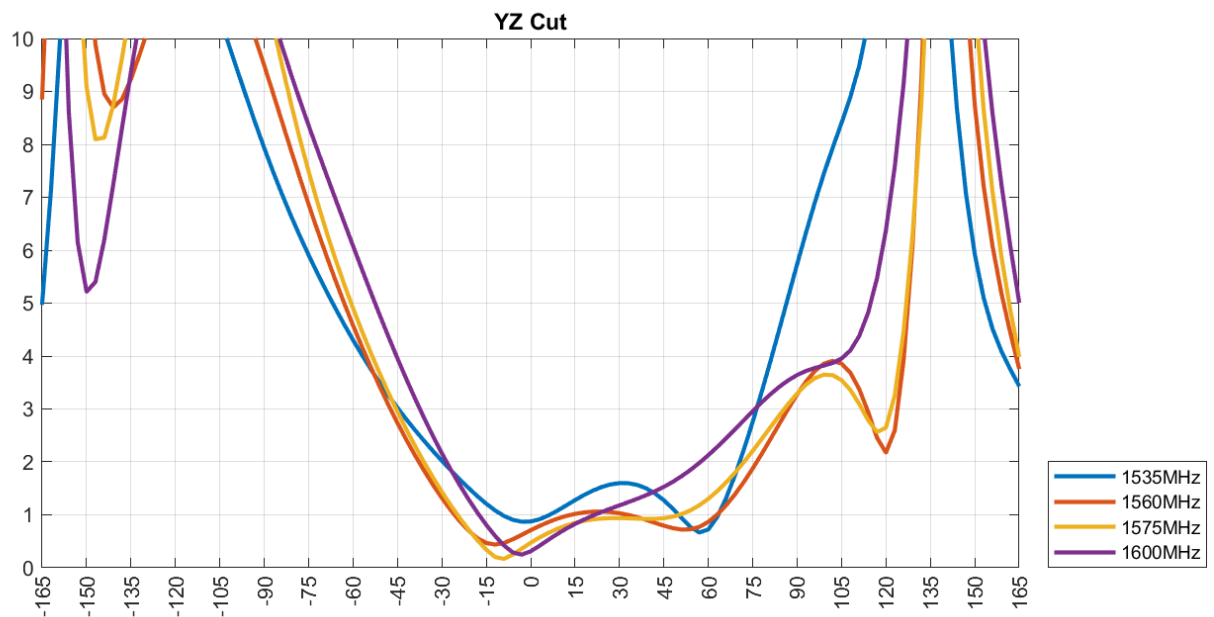
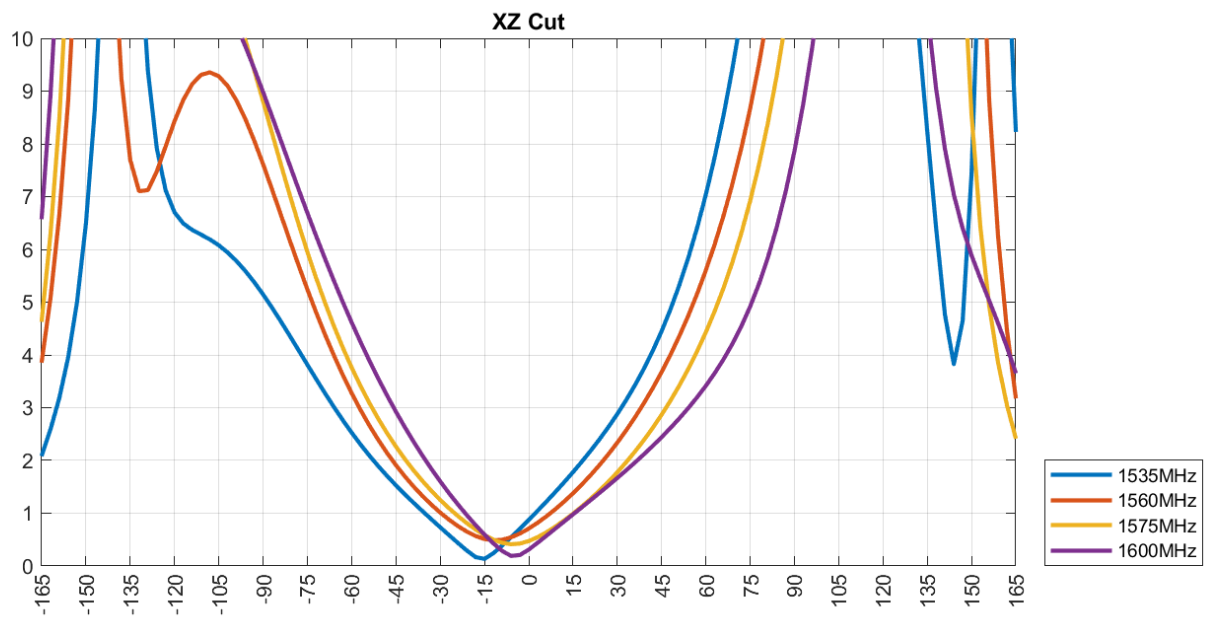

3.9 Axial Ratio (Low Band)

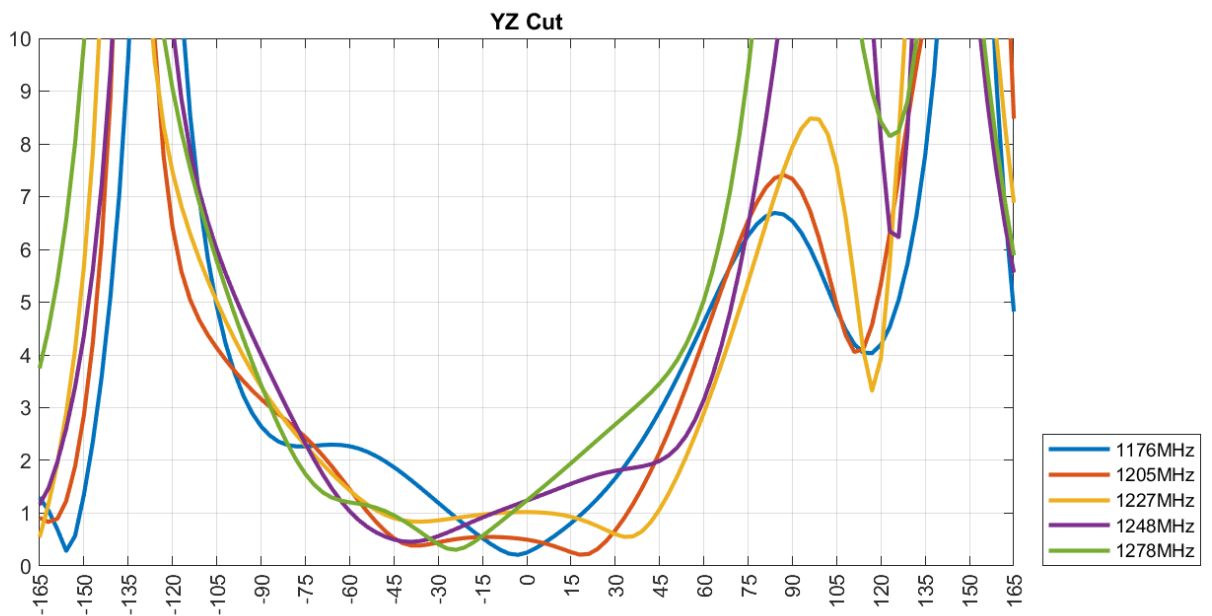
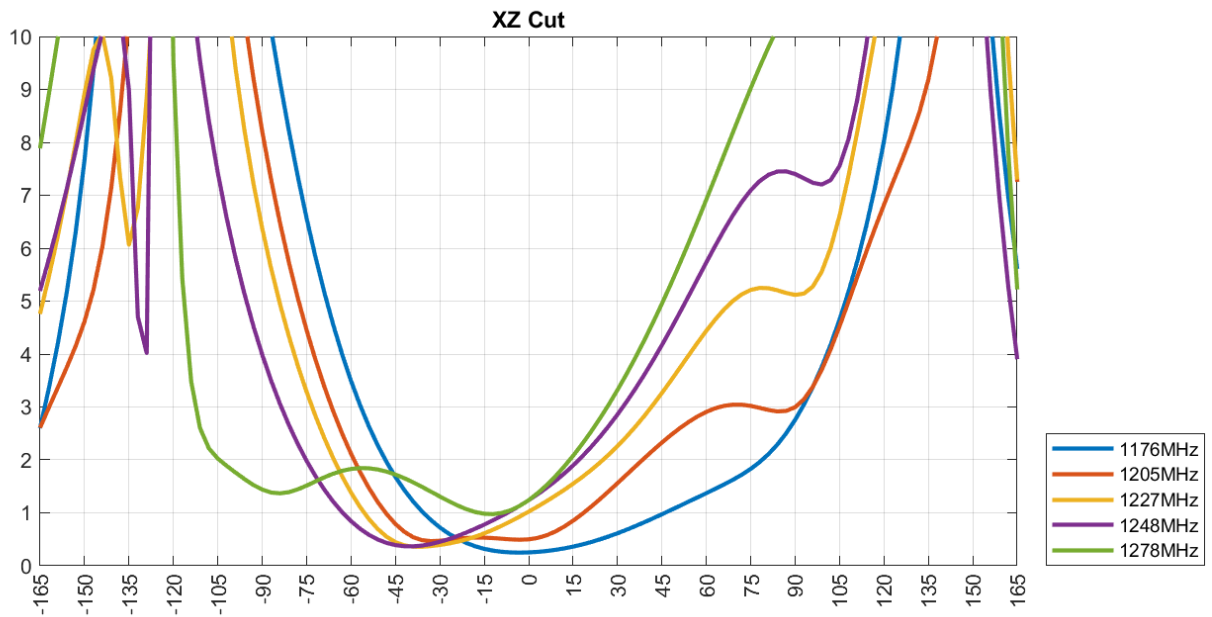

4. Radiation Patterns

4.1 Test Setup

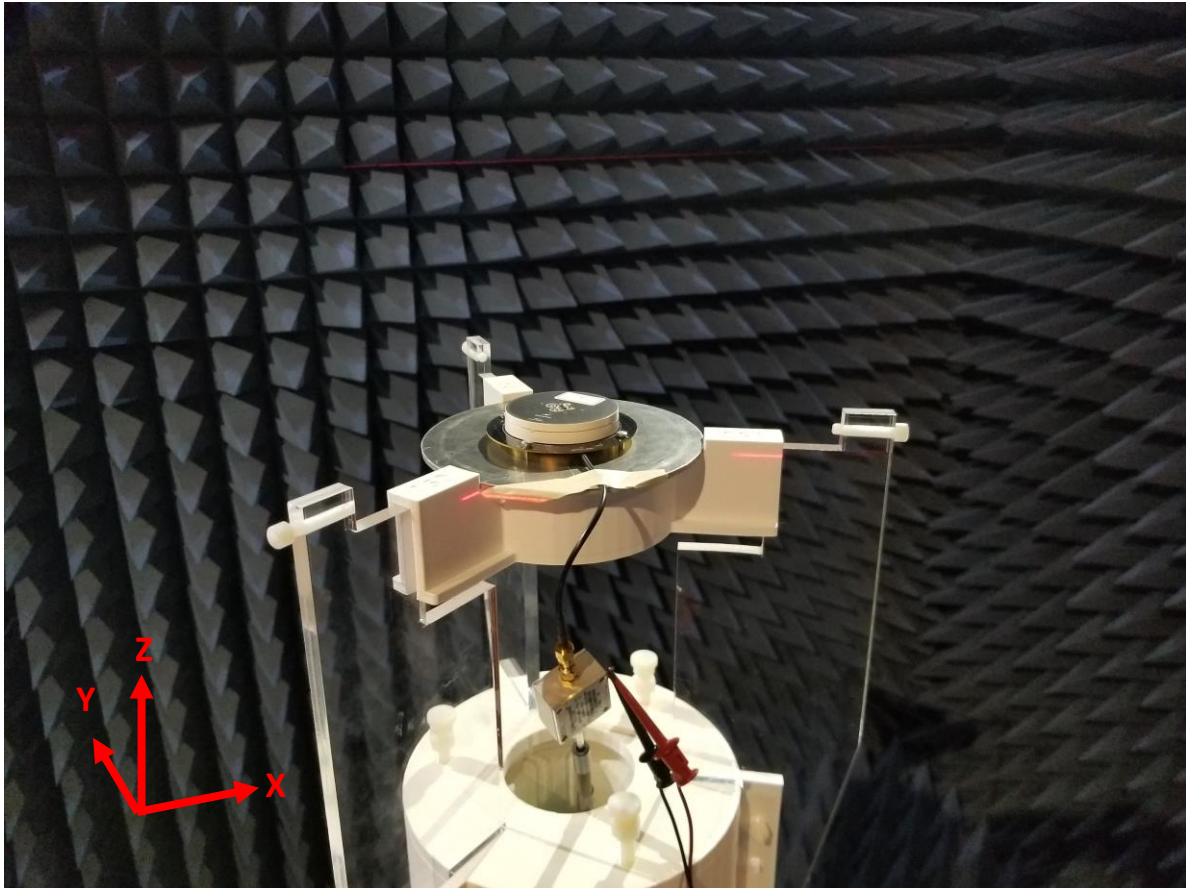

4.2 3D and 2D Radiation Patterns

1176.45MHz

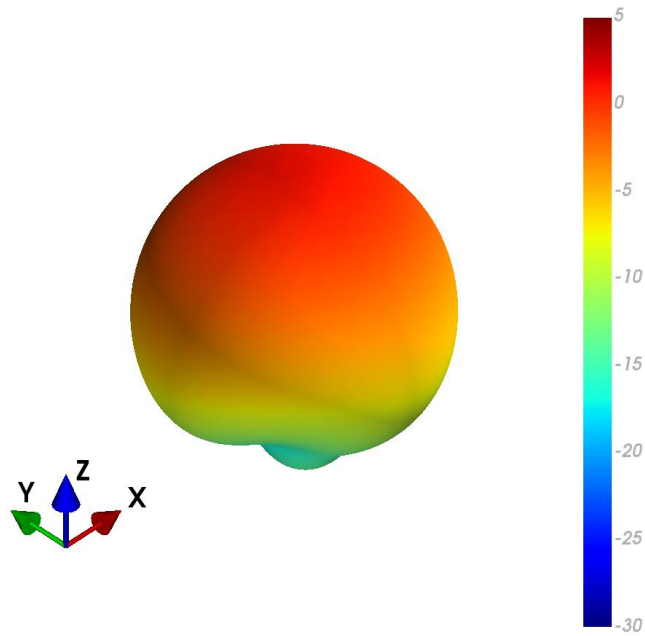

XY Plane

XZ Plane

YZ Plane

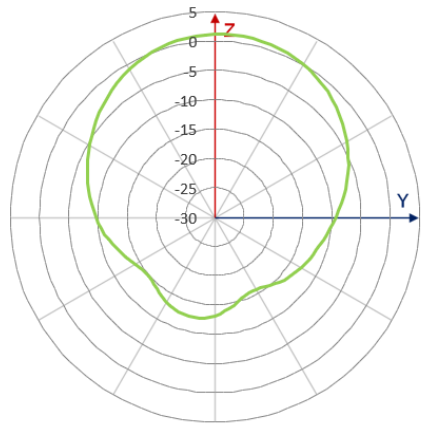
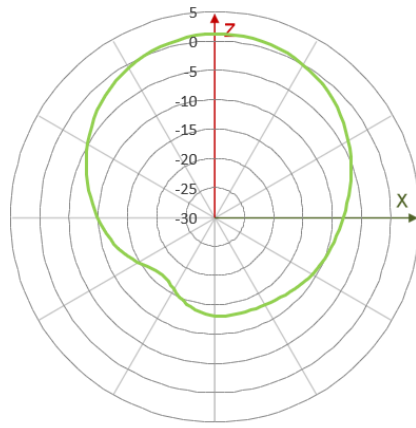
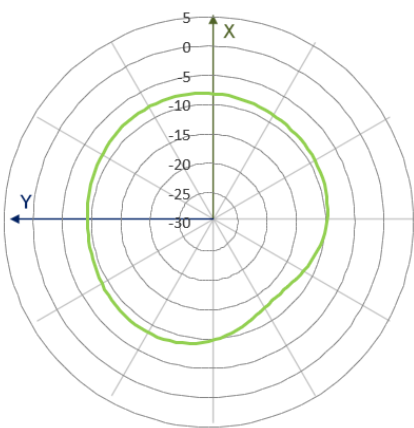

1205MHz

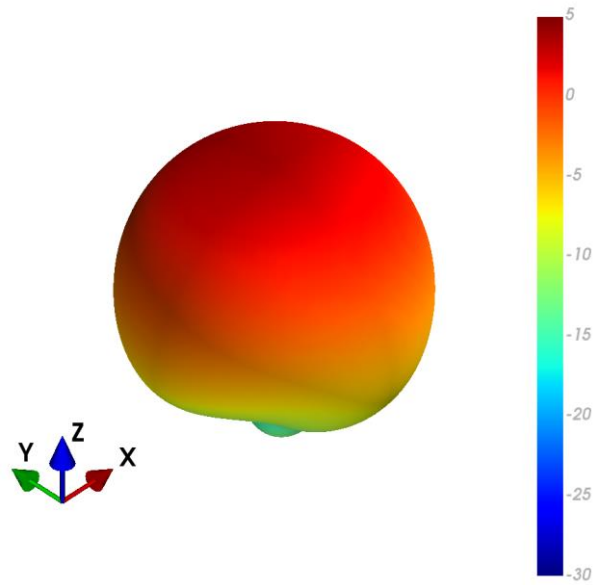

XY Plane

XZ Plane

YZ Plane

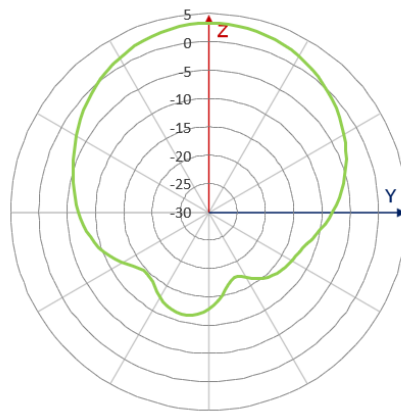
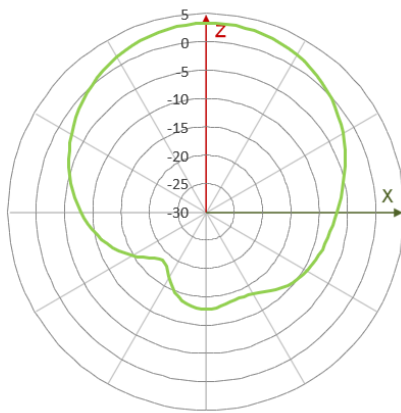
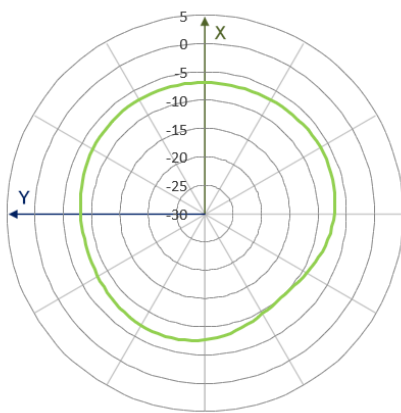

1227MHz

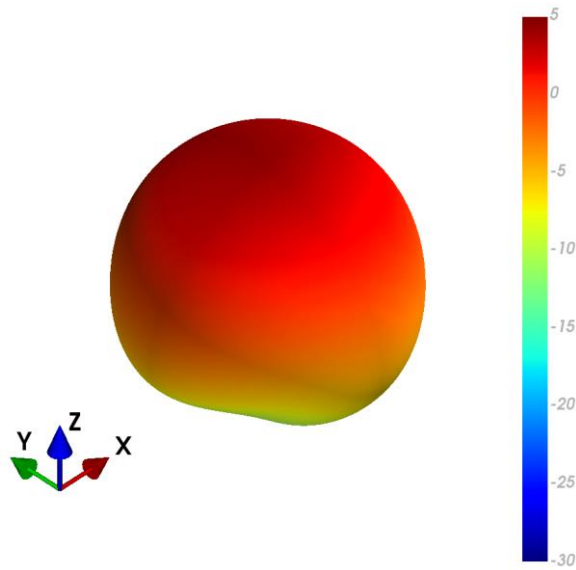

XY Plane

XZ Plane

YZ Plane

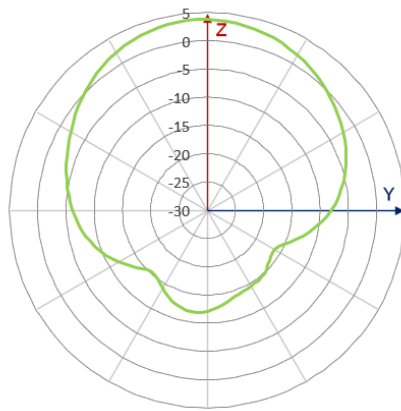
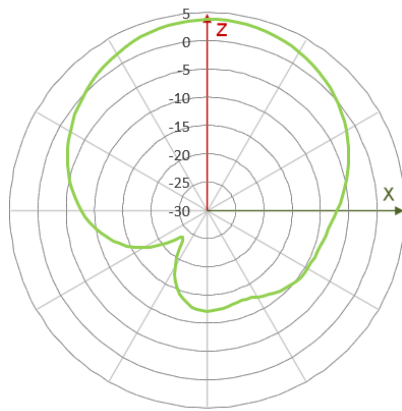
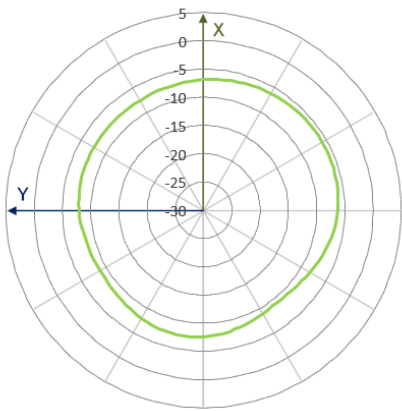

1248MHz

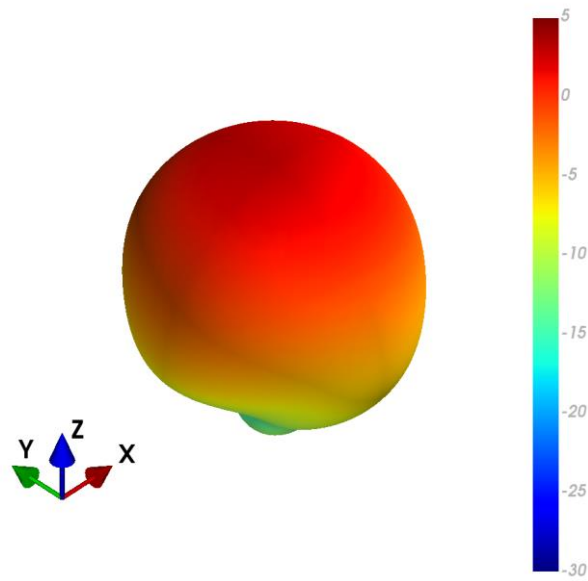

XY Plane

XZ Plane

YZ Plane

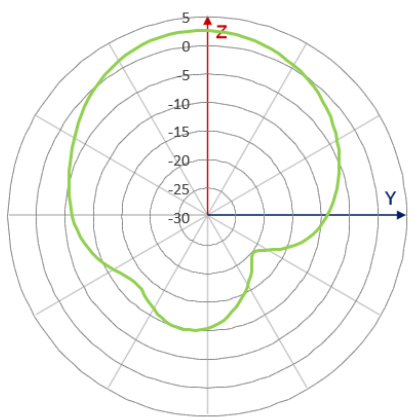
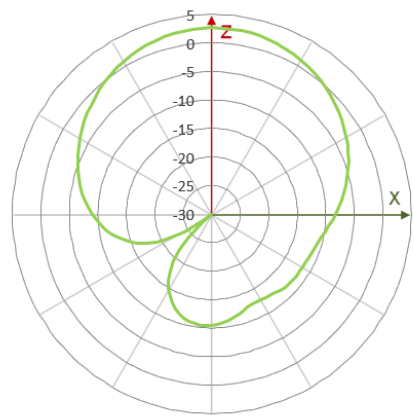
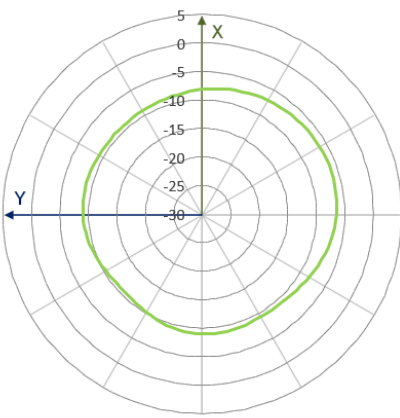

1278MHz

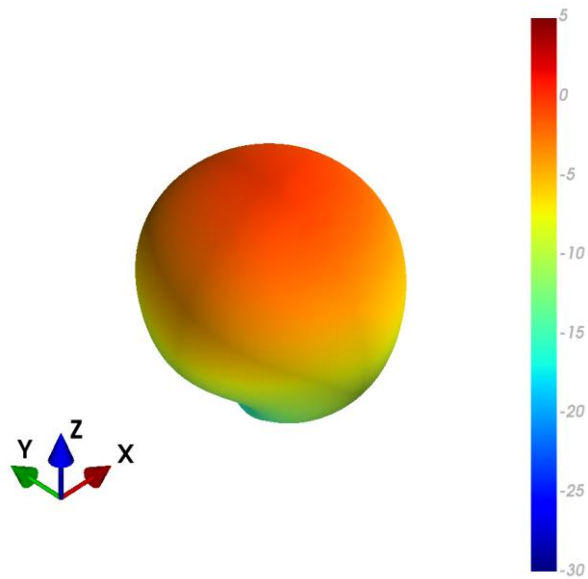

XY Plane

XZ Plane

YZ Plane

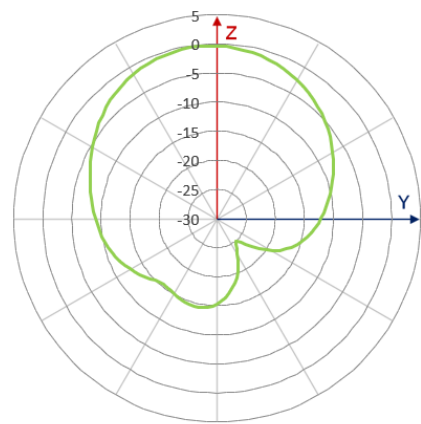
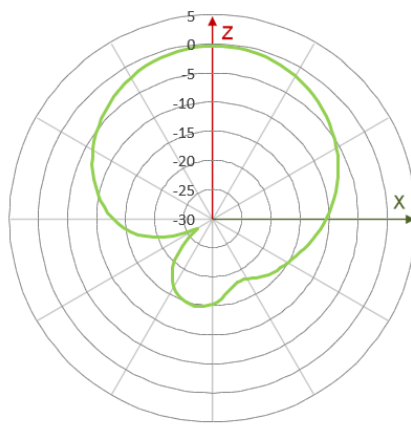
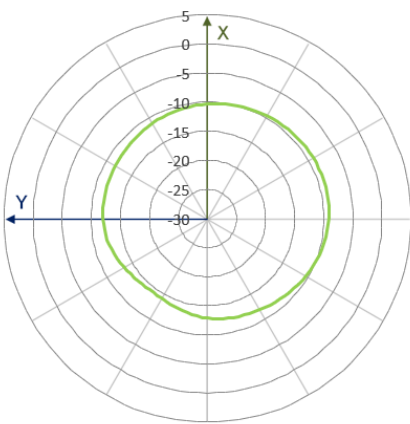

1561MHz

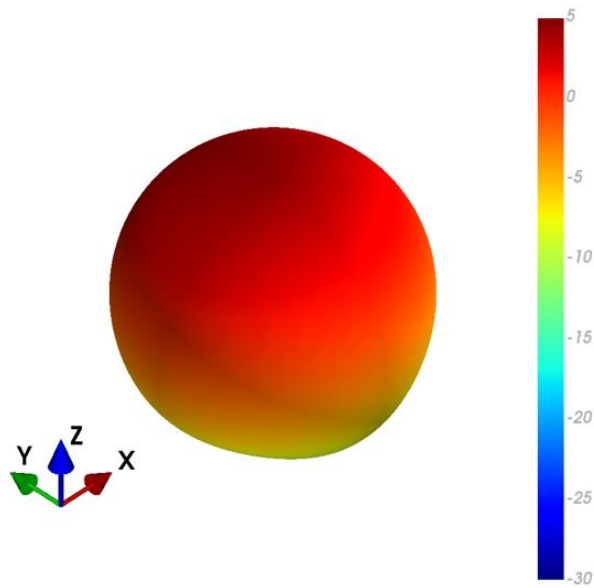

XY Plane

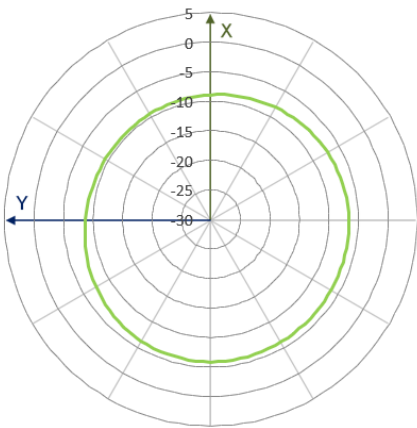

XZ Plane

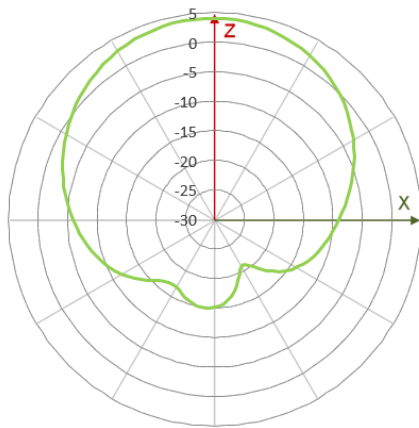

YZ Plane

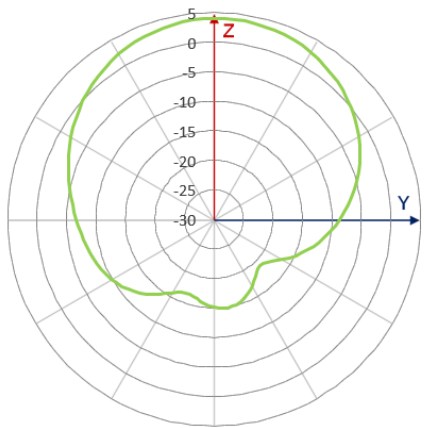

1575MHz

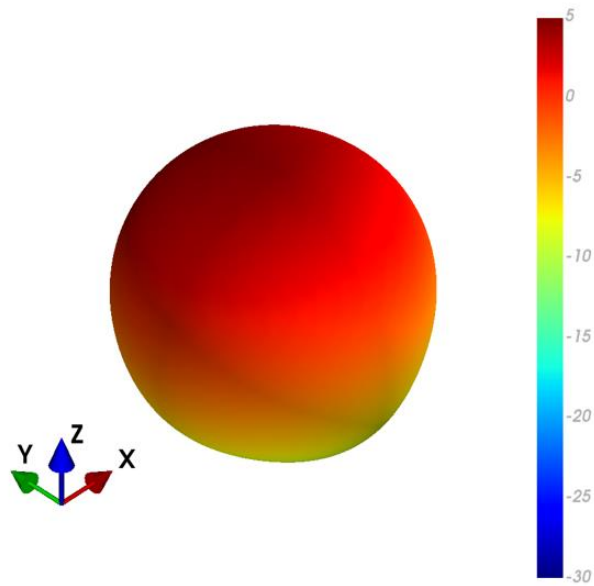

XY Plane

XZ Plane

YZ Plane

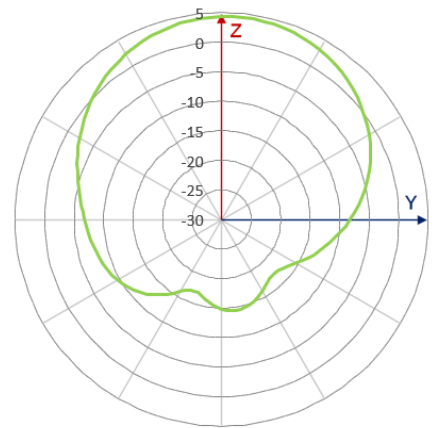
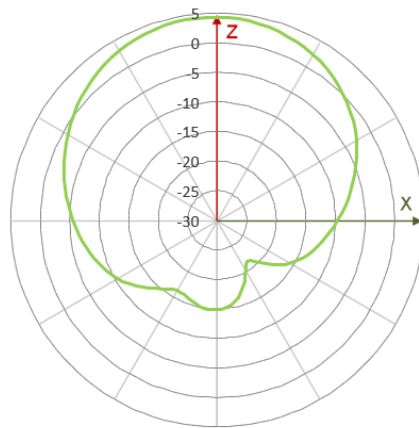
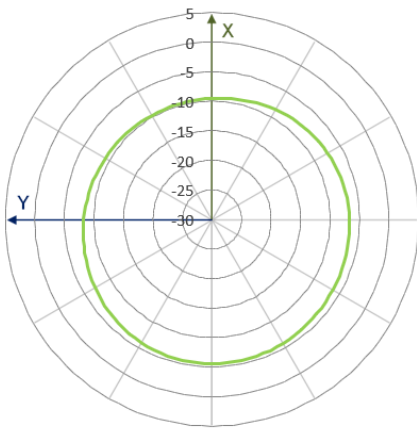

1602MHz

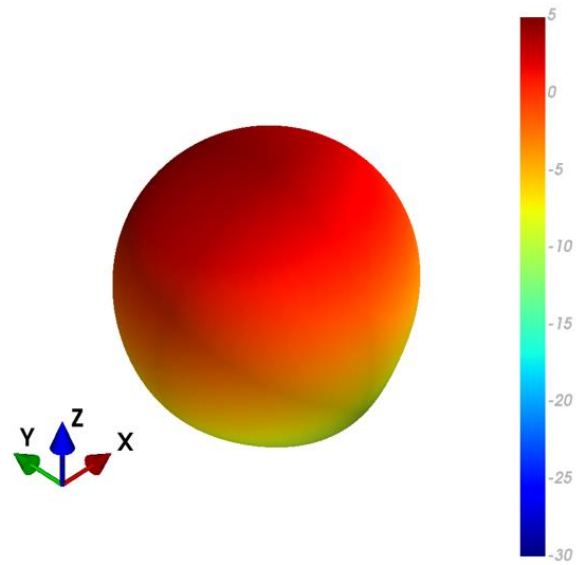

XY Plane

XZ Plane

YZ Plane

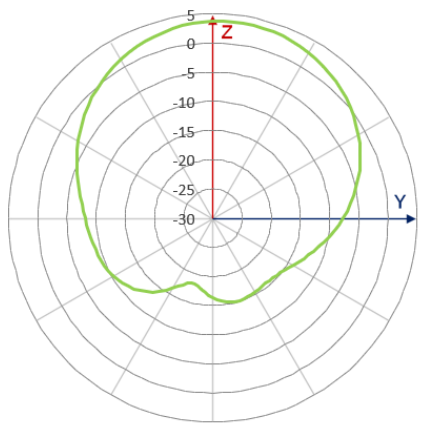
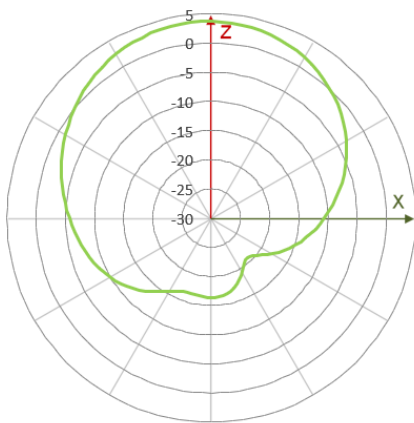
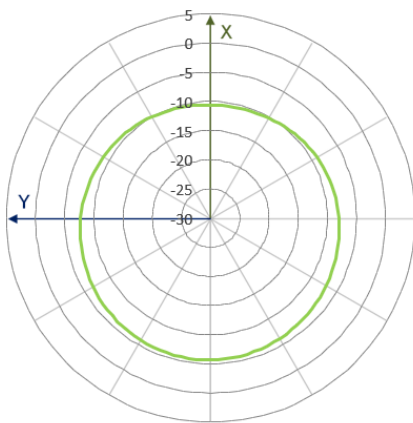

5. LNA Characteristics

5.1 Block Diagram (Active Antenna)

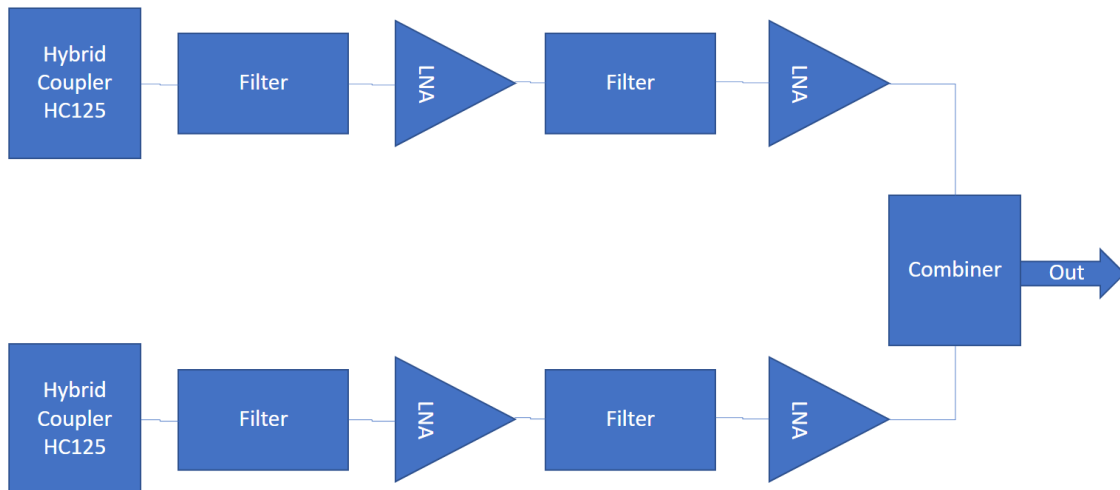

5.2 LNA Gain (High Band)

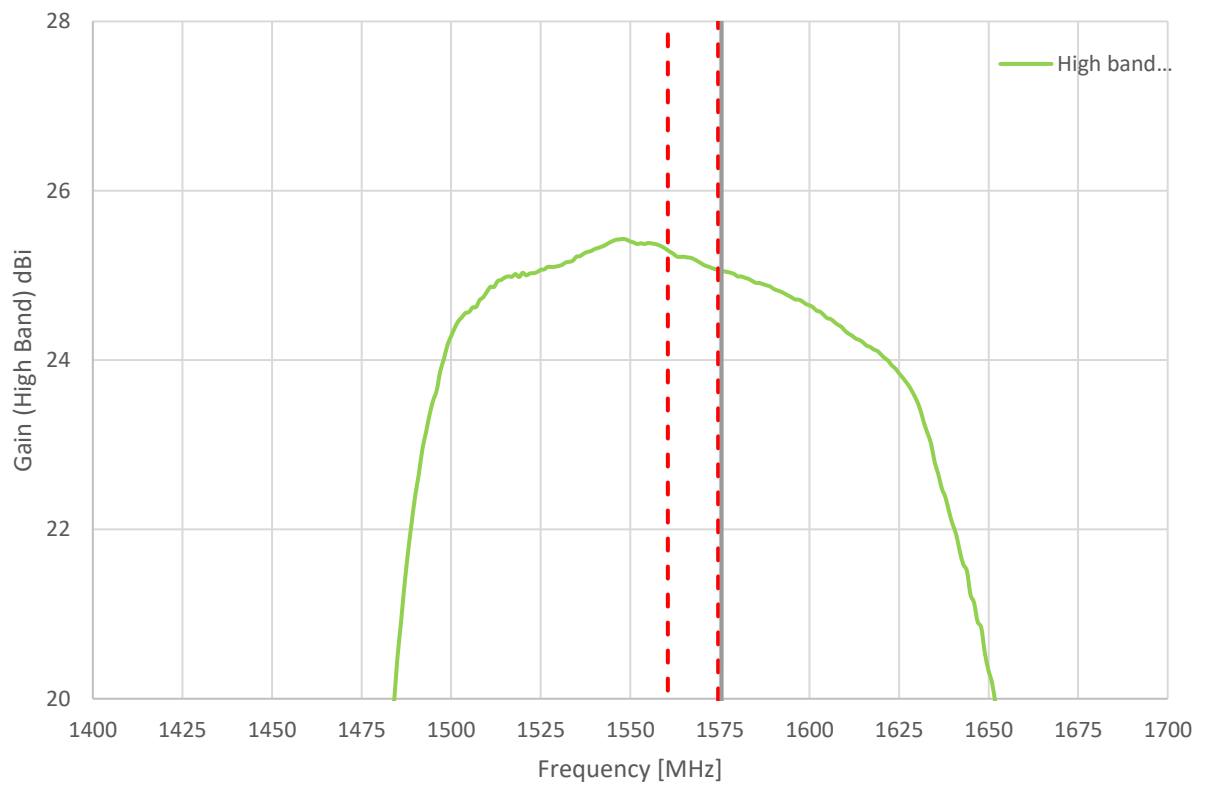

5.3 LNA Gain (Low Band)

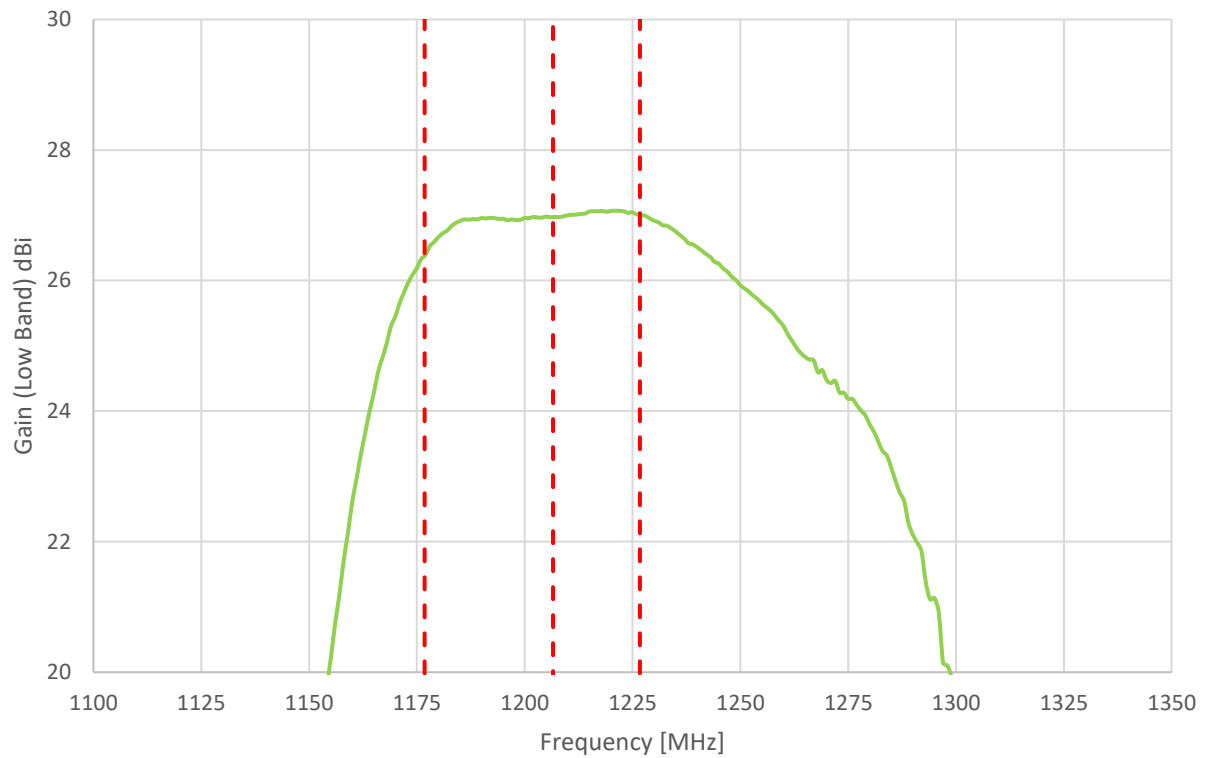

5.4 Noise Figure (High Band)

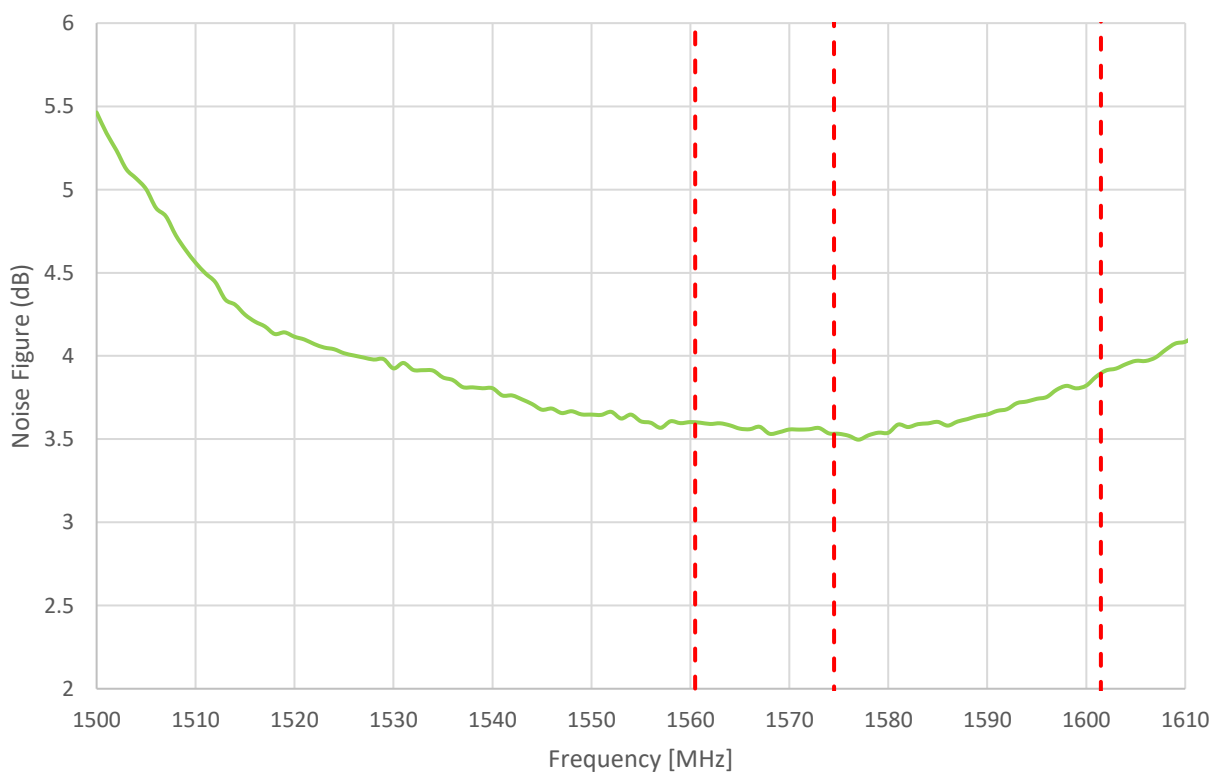

5.5 Noise Figure (Low Band)

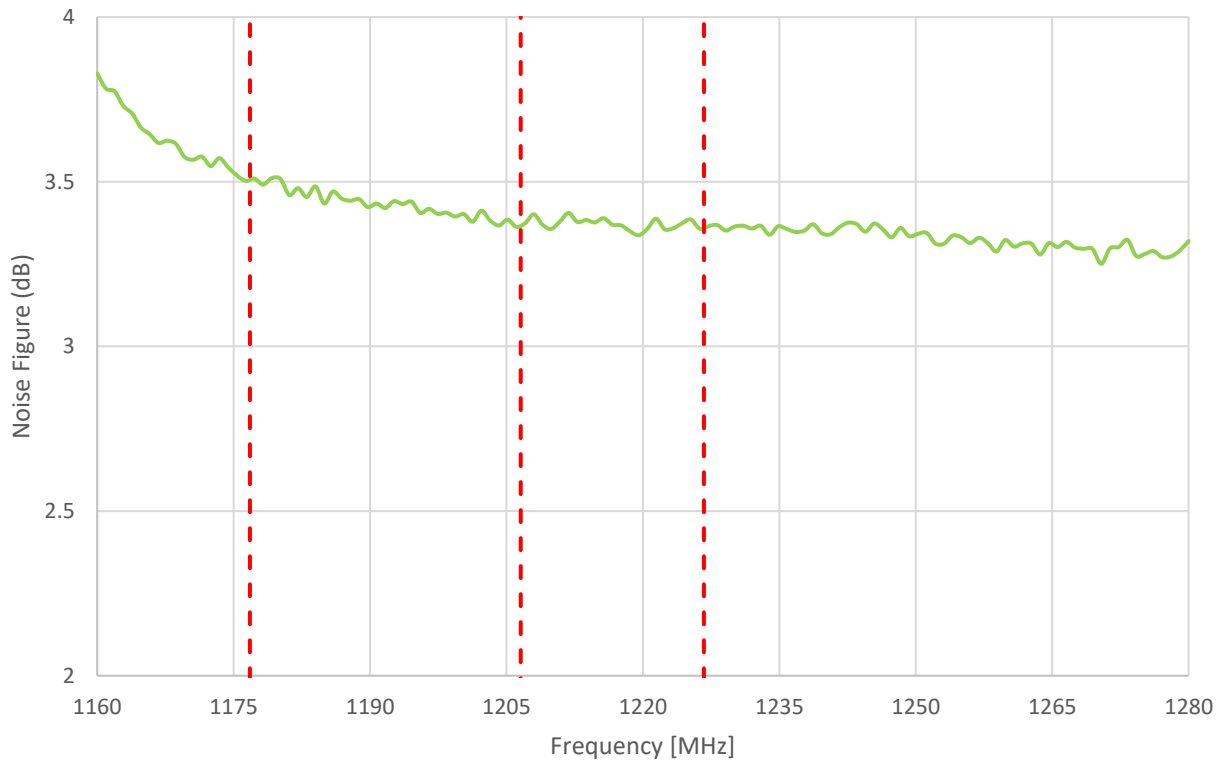

5.6 LNA Gain (Wide Band)

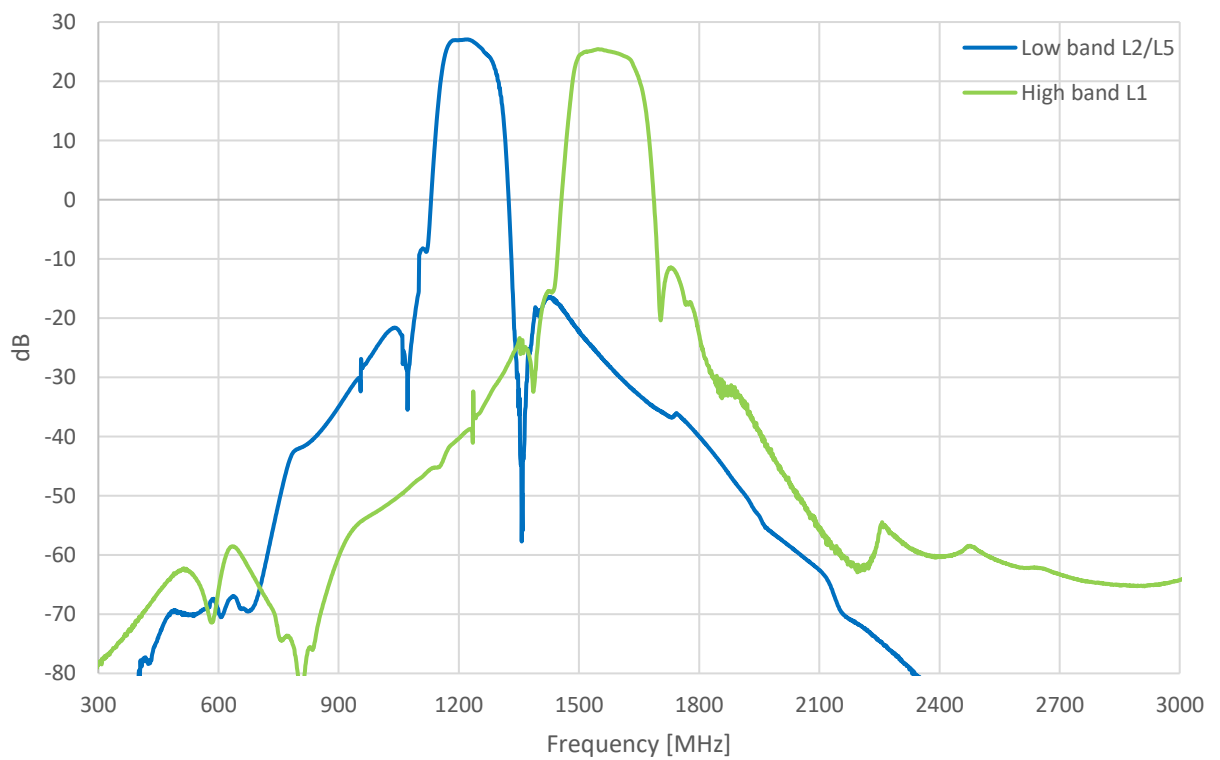

5.7 Group Delay (High Band)

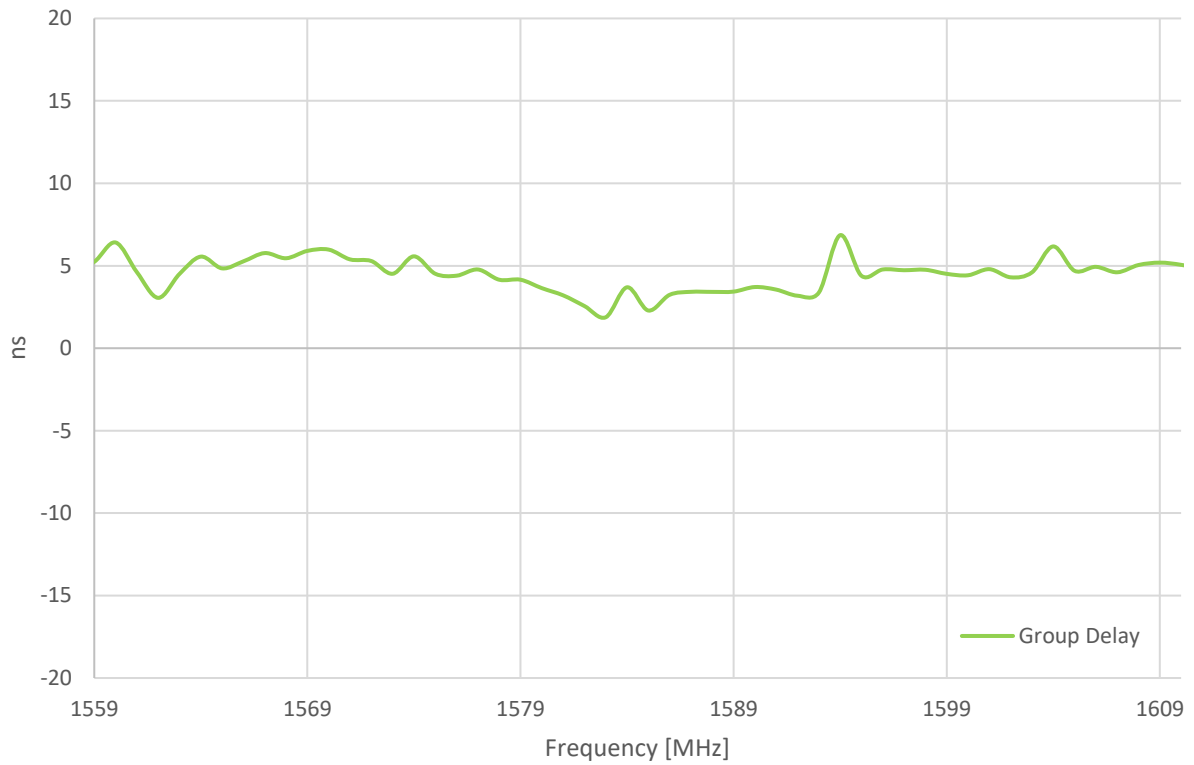

5.8 Group Delay (Low Band)

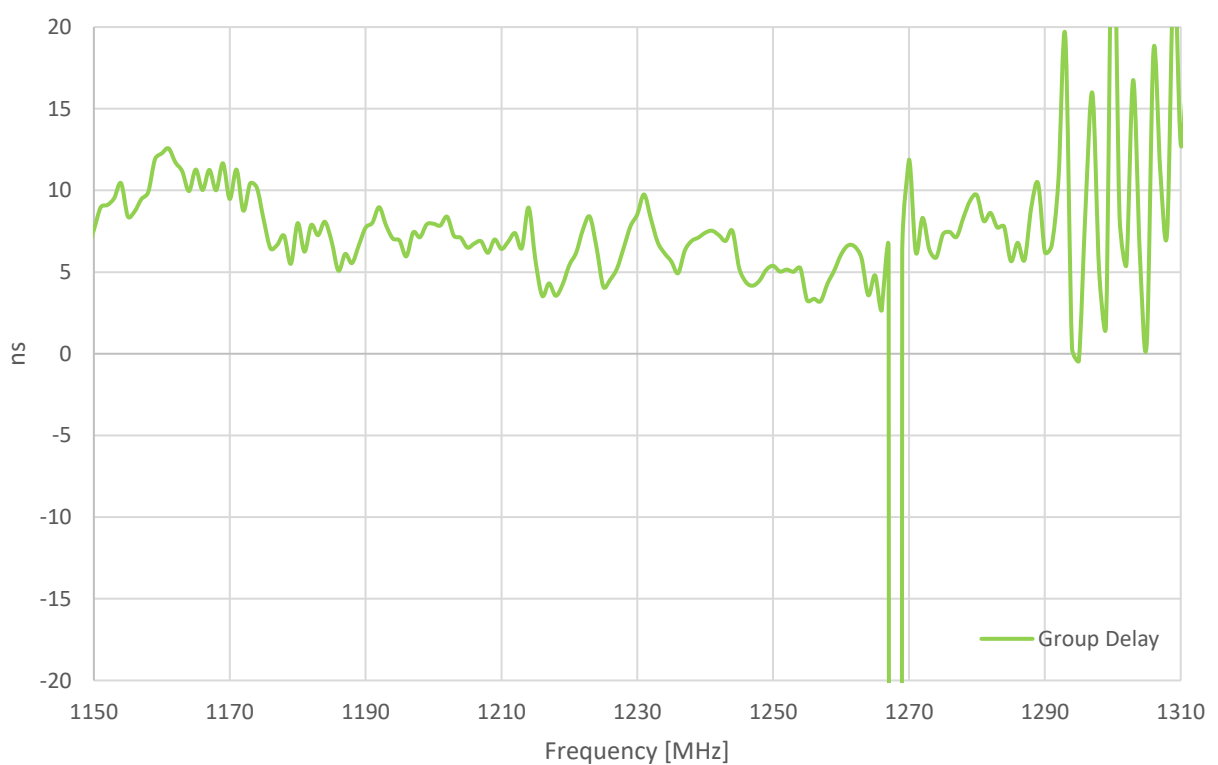

6. Mechanical Drawing (Units: mm)

ISO NO.: EDW-21-8-1471

STATE: Released

NOTES: 1.All material RoHS compliant.

REV	ZONE	DESCRIPTION	ENG	APPROVED	DATE
001	All	Initial Release	G. Samson	I. Mendez	12/16/2021
002	All	Active Board artwork (ie updated)	G. Samson	I. Mendez	12/27/2021
003	All	Changed cable length dimension reference location.	G. Samson	I. Mendez	1/7/2022
004	All	Updated PCB artwork, Added label and added anti-customer mounting detail	G. Samson	I. Mendez	2/21/2022

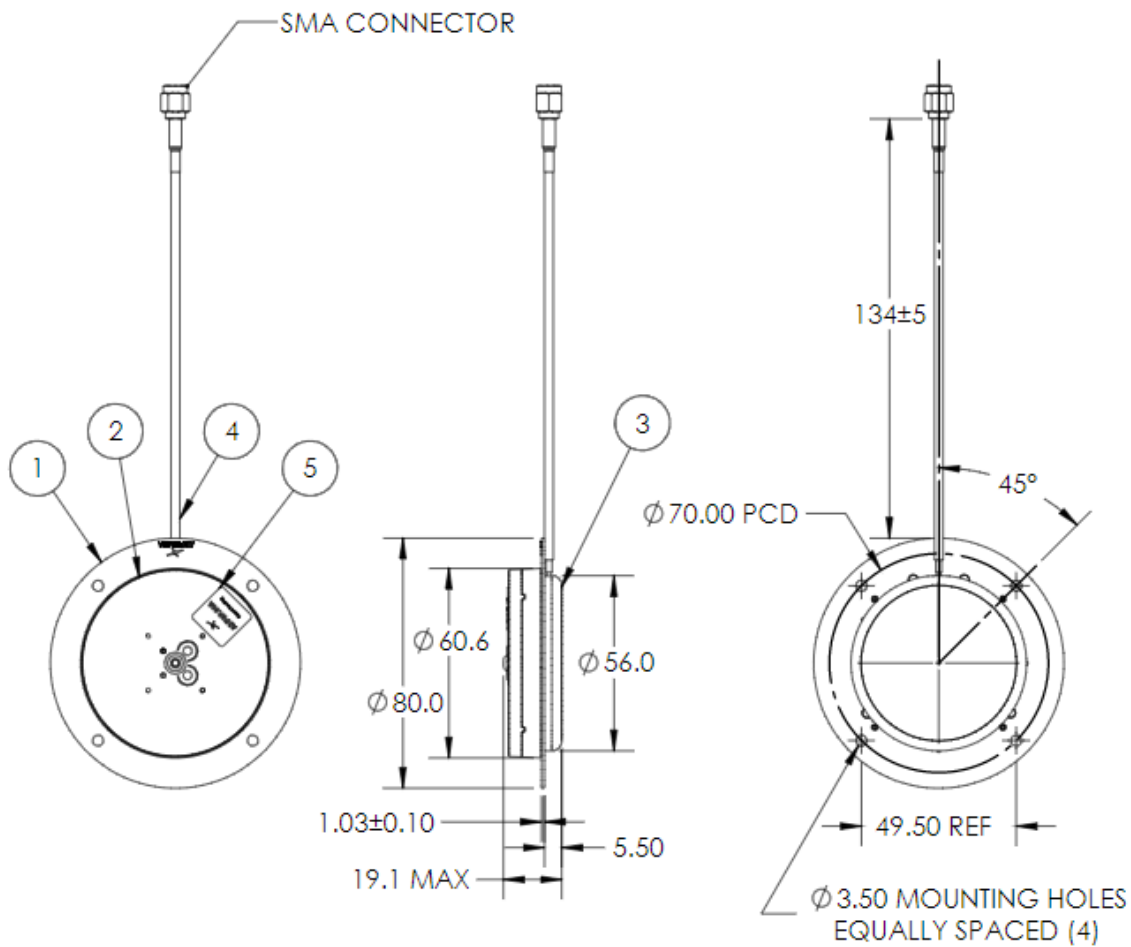

	Name	Material	Finish	QTY
1	PCB, RigID, IT180A, 1 m Thk, 80 mm Dia.	FR4	NA	1
2	GNSS Dual Feed Stacked Antenna	NA	NA	1
3	Shield, Round, 56.1 mm Diameter	Steel	Tin	1
4	Cable Assy, ADFGP8010A, RG-174 150 mm Lg SMA (M)	NA	NA	1
5	Label, Product Part Number, ADFGP.60A	PET	NA	1

APPROVED BY: P. Frank	<p>TAOGLAS™ Design Centre This drawing and its inherent design concepts are property of Taoglas. Not to be copied or given to third parties without the written consent of Taoglas.</p>
CHECK BY: I. Mendez	
DRAWN BY: G. Samson	
DATE: 12/16/2021	
UNLESS OTHERWISE SPECIFIED TOLERANCES ON: <ul style="list-style-type: none"> XX.XX ± 0.5 XX.XX ± 0.2 XX.XX ± 0.1 XXX.XX ± 0.25 	TITLE: Active All Band GNSS High Precision Antenna
THIRD ANGLE PROJECTION	PART NO.: ADFGP.60A.01.0150D
	UNIT: mm
	SCALE: 1:5
	PAGES: 1/1
	REV: D04

7. Packaging

1pcs ADFGP.60A.01.0150D per PE Bag
Weight: 73g



90pcs ADFGP.60A.01.0150D per Carton
Dimensions: 370*370*300 mm
Weight: 8Kg

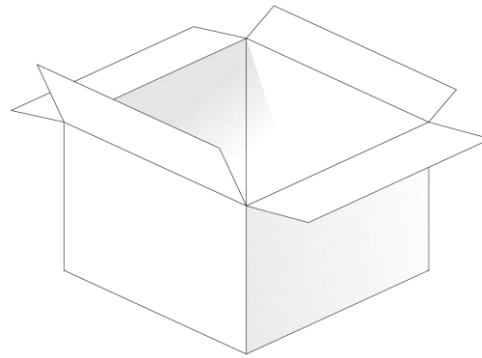

8. Installation Recommendation

ISO NO.: EDW-21-8-1471
STATE: Released

ANTENNA MOUNTING

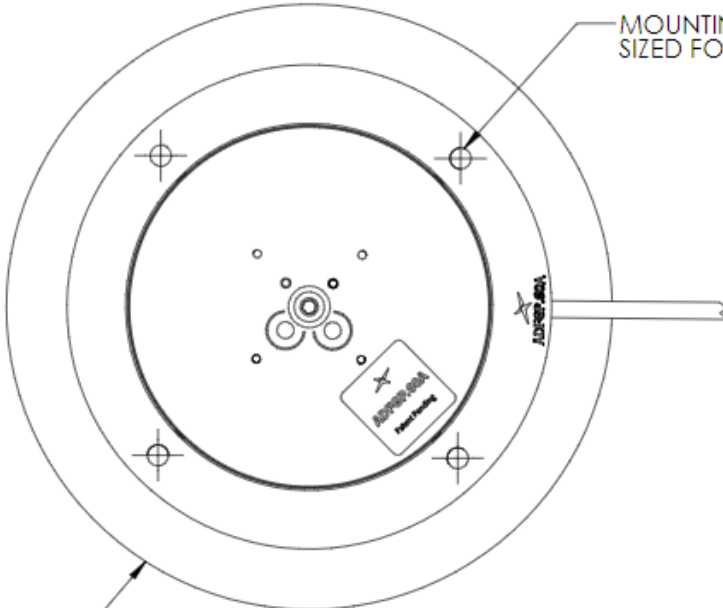

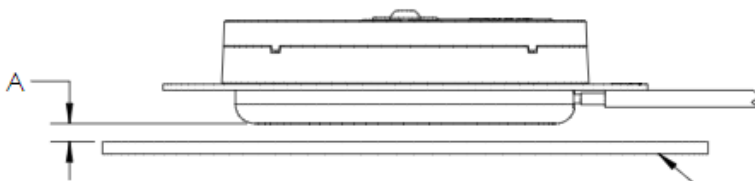

MOUNTING HOLES
SIZED FOR M3 HARDWARE

MINIMUM DIAMETER METALLIC GROUND PLANE RECOMMENDED
IS 100 mm.



GROUND PLANE

ANTENNA MOUNTING RECOMMENDATIONS			
GROUND PLANE MATERIAL	DIMENSION "A" (millimeters)		MOUNTING HARDWARE
	MIN	MAX	
METALLIC	0.5	20	CONDUCTIVE FASTENERS/SPACERS
METALLIC	0.5	3	NON-CONDUCTIVE FASTENERS/SPACERS

APPROVED BY: P. Frank	 <small>TAOGLAS™ TV Design Centre</small> <small>This drawing and its inherent design concepts are property of Taoglas. Not to be copied or given to third parties without the written consent of Taoglas.</small>								
CHECK BY: I. Mendez									
DRAWN BY: G. Samson	TITLE: Active All Band GNSS High Precision Antenna								
DATE: 12/16/2021	PART NO.: ADFGP.60A.01.0150D								
UNLESS OTHERWISE SPECIFIED TOLERANCES ON: <table style="font-size: small; margin-left: 10px;"> <tr><td>XXXXX</td><td>XXXXX</td></tr> <tr><td>XXXXX</td><td>XXXXX</td></tr> <tr><td>XXXXX</td><td>XXXXX</td></tr> <tr><td>XXXXX</td><td>XXXXX</td></tr> </table>	XXXXX	XXXXX	XXXXX	XXXXX	XXXXX	XXXXX	XXXXX	XXXXX	UNIT: mm
XXXXX	XXXXX								
XXXXX	XXXXX								
XXXXX	XXXXX								
XXXXX	XXXXX								
THIRD ANGLE PROJECTION 	SCALE: 1:5	SIZES: 2/2	REV: D04						

Changelog for the datasheet

SPE-22-8-143 – ADFGP.60A.01.0150D

Revision: C (Current Version)	
Date:	2023-02-22
Changes:	Updated GNSS Bands & Constellations Graphics
Changes Made by:	Cesar Sousa

Previous Revisions

Revision: B	
Date:	2022-10-06
Changes:	Updated electrical specifications
Changes Made by:	Cesar Sousa

Revision: A (Initial Release)	
Date:	2022-09-09
Changes:	Initial Release
Changes Made by:	Gary West



TAOGLAS®

www.taoglas.com

