

Main Product Characteristics

V_{DSS}	-30V
$R_{DS(ON)}$	41m Ω (Typ.)
I_D	-4.4A

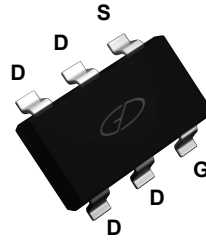

SOT-23-6L

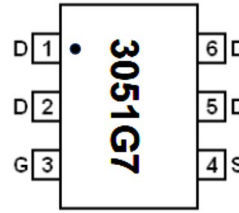

Marking and Pin Assignment

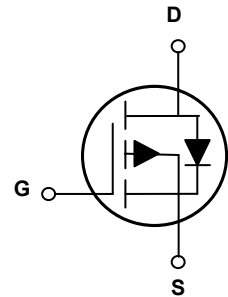

Schematic Diagram

Features and Benefits

- Advanced MOSFET process technology
- Ideal for high efficiency switched mode power supplies
- Low on-resistance with low gate charge
- Fast switching and reverse body recovery



Description

The SSF3051G7 utilizes the latest techniques to achieve high cell density and low on-resistance. These features make this device extremely efficient and reliable for use in high efficiency switch mode power supplies and a wide variety of other applications.

Absolute Maximum Ratings (T_A=25°C unless otherwise specified)

Parameter	Symbol	Max.	Unit
Drain-Source Voltage	V_{DS}	-30	V
Gate-Source Voltage	V_{GS}	±25	V
Drain Current-Continuous @ Current - Pulsed ¹	I_D	-4.4	A
Drain Current-Pulsed ²	I_{DM}	-25	A
Maximum Power Dissipation	P_D	1.7	W
Thermal Resistance, Junction-to-Ambient ¹	$R_{\theta JA}$	75	°C/W
Thermal Resistance, Junction-to-Case ¹	$R_{\theta JC}$	30	°C/W
Operating Junction Temperature Range	T_J	-55 To +150	°C
Storage Temperature Range	T_{STG}	-55 To +150	°C



Electrical Characteristics ($T_A=25^\circ\text{C}$ unless otherwise specified)

Parameter	Symbol	Conditions	Min.	Typ.	Max.	Unit
On / Off Characteristics						
Drain-Source Breakdown Voltage	BV_{DSS}	$V_{GS}=0V, I_D=-250\mu A$	-30	-	-	V
Drain-Source Leakage Current	I_{DSS}	$V_{DS}=-24V, V_{GS}=0V$	-	-	-1	μA
Gate-Source Leakage Current	I_{GSS}	$V_{GS}=\pm 25V, V_{DS}=0V$	-	-	± 100	nA
Static Drain-Source On-Resistance ³	$R_{DS(ON)}$	$V_{GS}=-10V, I_D=-4.4A$	-	41	48	m Ω
		$V_{GS}=-4.5V, I_D=-3.4A$	-	57	75	
Gate Threshold Voltage ³	$V_{GS(th)}$	$V_{GS}=V_{DS}, I_D=-250\mu A$	-1	-1.6	-3	V
Forward Transconductance ³	g_{fs}	$V_{DS}=-5V, I_D=-4A$	-	8.5	-	S
Dynamic and Switching Characteristics						
Total Gate Charge ⁴	Q_g	$V_{DS}=-5V, I_D=-4A, V_{GS}=-5V$	-	7.1	-	nC
Gate-Source Charge ⁴	Q_{gs}		-	0.86	-	
Gate-Drain Charge ⁴	Q_{gd}		-	3.9	-	
Turn-On Delay Time ⁴	$t_{d(on)}$	$V_{DD}=-15V, R_G=6\Omega, V_{GS}=-10V, I_D=-1A$	-	8.9	-	nS
Rise Time ⁴	t_r		-	4	-	
Turn-Off Delay Time ⁴	$t_{d(off)}$		-	22.6	-	
Fall Time ⁴	t_f		-	5.5	-	
Input Capacitance ⁴	C_{iss}	$V_{DS}=-15V, V_{GS}=0V, F=1MHz$	-	520	-	pF
Output Capacitance ⁴	C_{oss}		-	94	-	
Reverse Transfer Capacitance ⁴	C_{rss}		-	73	-	
Gate Resistance ³	R_g	$V_{GS}=0V, V_{DS}=0V, F=1MHz$	-	0.95	2	Ω
Drain-Source Diode Characteristics and Maximum Ratings						
Diode Forward Voltage ³	V_{SD}	$V_{GS}=0V, I_S=-1.3A$	-	-0.8	-1.2	V
Continuous Source Current ²	I_S	-	-	-	-4.4	A
Reverse Recovery Time	t_{rr}	$T_J=25^\circ\text{C}, I_F=-4A, di/dt=-100A/\mu s$	-	10.3	-	nS
Reverse Recovery Charge	Q_{rr}		-	4.3	-	nC

Note:

1. Device mounted on 1"x1" FR-4PC board on 0.1 inch² pads on 2oz copper pads and test pulse width $t \leq 10s$.
2. Repetitive Rating: pulse width limited by maximum junction temperature.
3. Pulse Test: pulse width $\leq 300\mu s$, duty cycle $\leq 2\%$.
4. Guaranteed by design, not subject to production testing.

Typical Electrical and Thermal Characteristics

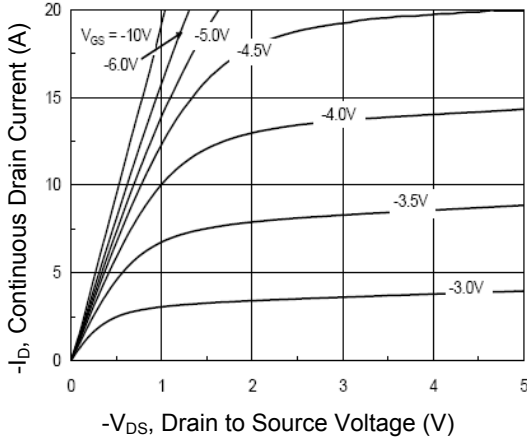

Figure 1. Typical Output Characteristics

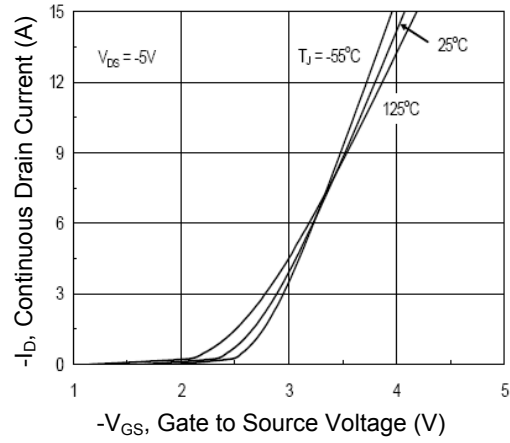

Figure 2. Transfer Characteristics

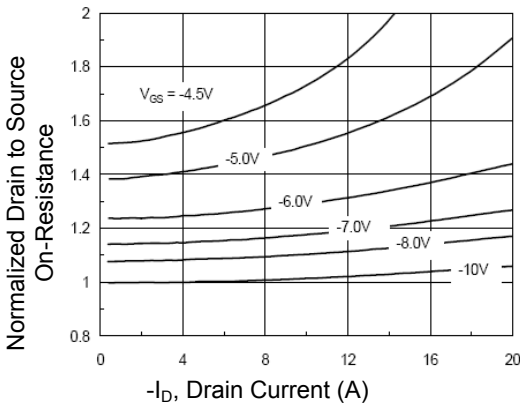

Figure 3. Drain-Source On-Resistance

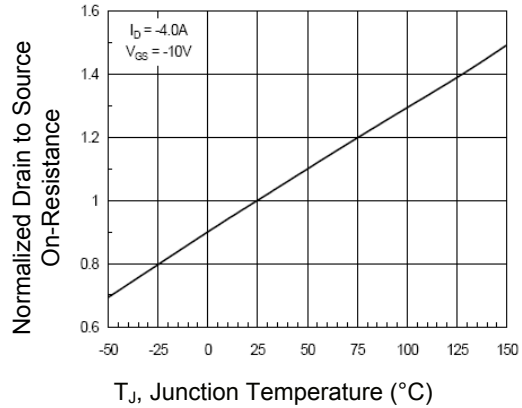

Figure 4. Drain - Source On-Resistance

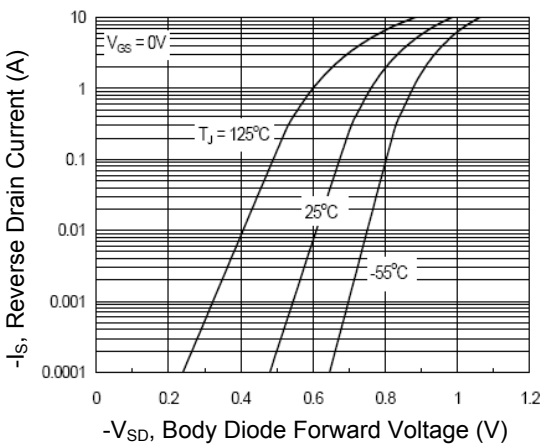

Figure 5. Source - Drain Diode Forward

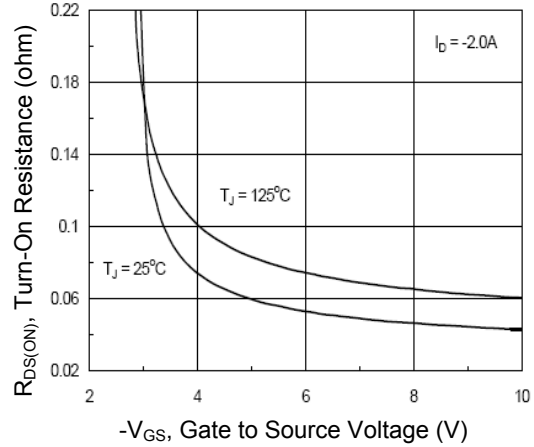

Figure 6. $R_{DS(ON)}$ vs. V_{GS}

Typical Electrical and Thermal Characteristics

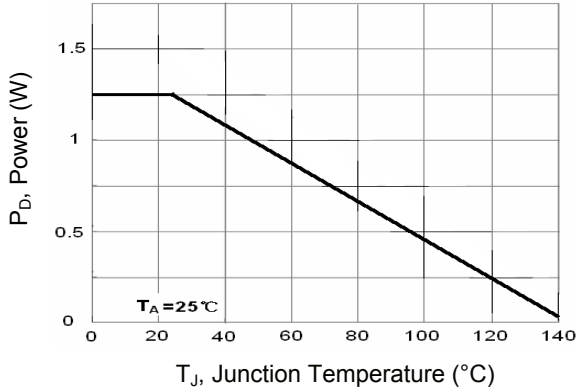

Figure 7. Power Dissipation

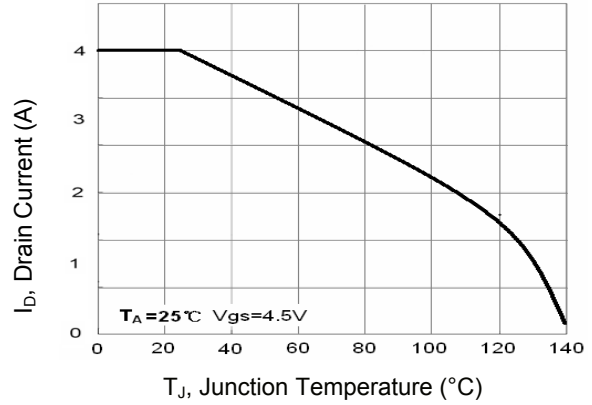

Figure 8. Drain Current

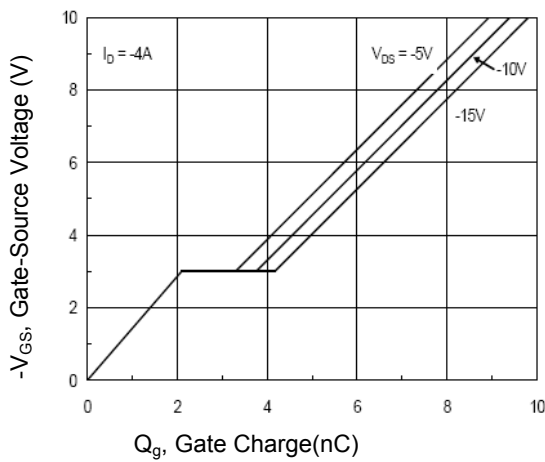

Figure 9. Gate Charge

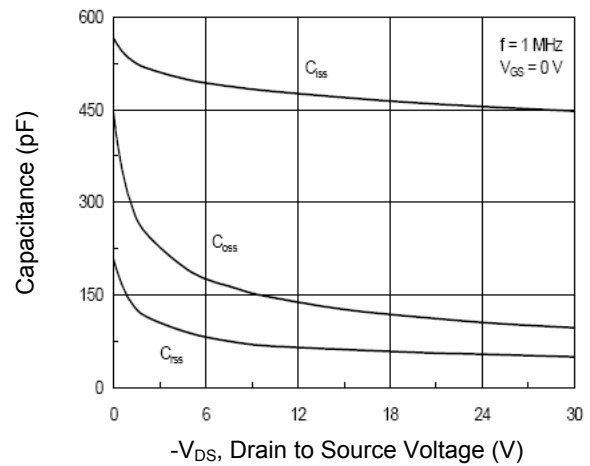

Figure 10. Capacitance vs. V_{DS}

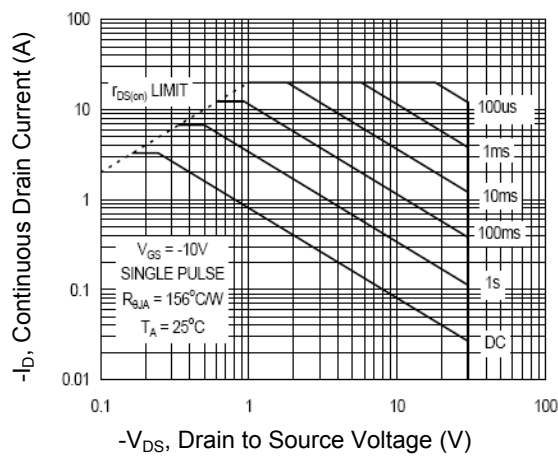

Figure 11. Safe Operation Area

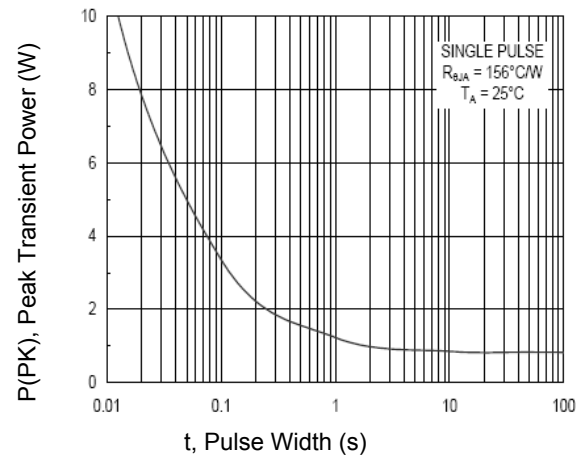

Figure 12. Single Pulse Maximum Power Dissipation

Typical Electrical and Thermal Characteristics

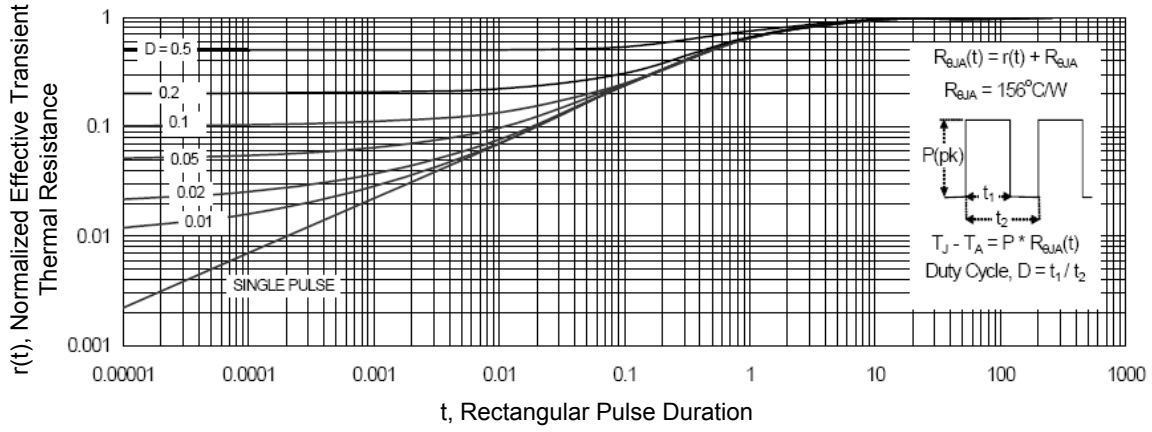
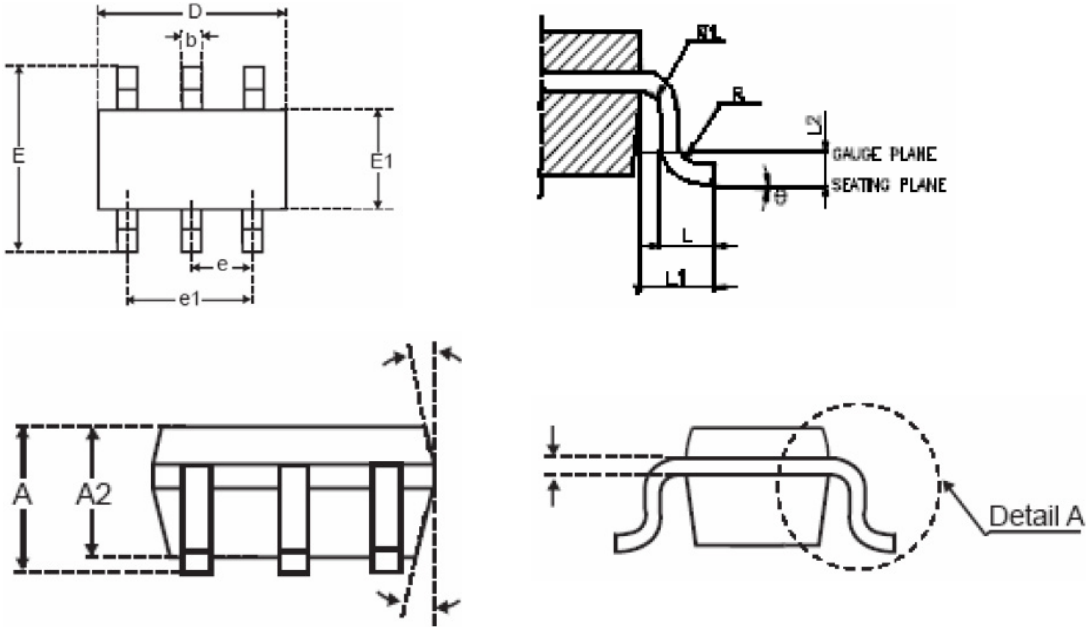

Figure 13. Normalized Maximum Transient Thermal Impedance

Package Outline Dimensions (SOT-23-6L)



Symbols	Dimensions in Millimeters		
	Min	Nom	Max
A	-	-	1.45
A1	-	-	0.15
A2	0.9	1.15	1.3
b	0.3	-	0.5
c	0.08	-	0.22
D	2.90 BSC		
E	2.80 BSC		
E1	1.60 BSC		
e	0.95 BSC		
e1	1.90 BSC		
L	0.3	0.45	0.6
L1	0.60 REF		
L2	0.25 BSC		
R	0.1	-	-
R1	0.1	-	0.25
θ	0°	4°	8°
θ1	5°	10°	15°

Note:

1. All dimensions are in millimeters.
2. Dimensions are inclusive of plating.
3. Package body sizes exclude mold flash and gate burrs. Mold flash at the non-lead sides should be less than 6 mils.
4. Dimension L is measured in gauge plane.
5. Controlling dimension is millimeter, converted inch dimensions are not necessarily exact.

Ordering Information

Device	Package	Marking Code	Carrier	Quantity
SSF3051G7	SOT-23-6L	3051G7	Tape & Reel	3,000 pcs / Reel