

Main Product Characteristics

$V_{(BR)DSS}$	20V
$R_{DS(ON)}$	70m Ω
I_D	2.5A

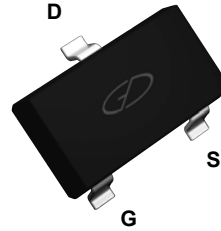

SOT-323

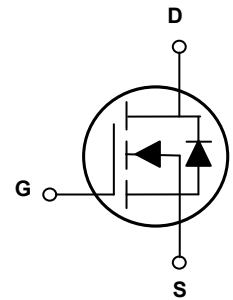

Schematic Diagram

Features and Benefits

- Advanced MOSFET process technology
- Ideal for high efficiency switch mode power supplies
- Low on-resistance with low gate charge
- Fast switching and reverse body recovery



Description

The GSKW0202 utilizes the latest techniques to achieve high cell density and low on-resistance. These features make this device extremely efficient and reliable for use in high efficiency switch mode power supply and a wide variety of other applications.

Absolute Maximum Ratings ($T_A=25^\circ\text{C}$ unless otherwise specified)

Parameter	Symbol	Max.	Unit
Drain-Source Voltage	V_{DS}	20	V
Gate-Source Voltage	V_{GS}	± 10	V
Continuous Drain Current, @Steady-State ($T_A=25^\circ\text{C}$) ¹	I_D	2.5	A
Continuous Drain Current, @Steady-State ($T_A=70^\circ\text{C}$) ¹		2	A
Pulsed Drain Current ²	I_{DM}	14	A
Power Dissipation($T_A=25^\circ\text{C}$)	P_D	0.7	W
Derating Factor($T_A=25^\circ\text{C}$)		5.6	W/ $^\circ\text{C}$
Junction-to-Ambient @Steady-State ³	$R_{\theta JA}$	178	$^\circ\text{C}/\text{W}$
Operating Junction Temperature Range	T_J	-55 To +150	$^\circ\text{C}$
Storage Temperature Range	T_{STG}	-55 To +150	$^\circ\text{C}$

Electrical Characteristics ($T_A=25^\circ\text{C}$ unless otherwise specified)

Parameter	Symbol	Conditions	Min.	Typ.	Max.	Unit
Drain-to-Source Breakdown Voltage	$V_{(BR)DSS}$	$V_{GS}=0V, I_D=250\mu A$	20	-	-	V
Drain-to-Source Leakage Current	I_{DSS}	$V_{DS}=20V, V_{GS}=0V$	-	-	1	μA
		$T_J=125^\circ C$	-	-	50	
Gate-to-Source Forward Leakage	I_{GSS}	$V_{GS}=+10V$	-	-	100	nA
		$V_{GS}=-10V$	-	-	-100	
Static Drain-Source On-State Resistance	$R_{DS(ON)}$	$V_{GS}=4.5V, I_D=2.5A$	-	57	70	m Ω
		$V_{GS}=2.5V, I_D=2.0A$	-	72	98	
Gate Threshold Voltage	$V_{GS(th)}$	$V_{DS}=V_{GS}, I_D=250\mu A$	0.55	0.78	1.1	V
Input Capacitance	C_{ISS}	$V_{DS}=10V, V_{GS}=0V, F=1.0MHz$	-	280	-	μF
Output Capacitance	C_{OSS}		-	46	-	
Reverse Transfer Capacitance	C_{RSS}		-	29	-	
Total Gate Charge	Q_g	$V_{DS}=10V, I_D=2.5A, V_{GS}=10V$	-	2.9	-	nC
Gate-Source Charge	Q_{gs}		-	0.4	-	
Gate-to-Drain("Miller") Charge	Q_{gd}		-	0.6	-	
Turn-On Delay Time	$t_{d(on)}$	$V_{DS}=10V, I_D=6.6A, R_L=1.5\Omega, V_{GS}=4.5V, R_{GEN}=3\Omega$	-	13	-	nS
Rise Time	t_r		-	54	-	
Turn-Off Delay Time	$t_{d(off)}$		-	18	-	
Fall Time	t_f		-	11	-	
Source-Drain Ratings and Characteristics						
Continuous Source Current (Body Diode) ²	I_S	MOSFET symbol showing the integral reverse p-n junction diode.	-	-	2.5	A
Pulsed Source-Drain Current (Body Diode)	I_{SM}		-	-	14	A
Diode Forward Voltage	V_{SD}	$I_S=2.5A, V_{GS}=0V$	-	0.86	1.2	V

Notes

1. Pulse test: Pulse Width $\leq 300\mu s$, Duty cycle $\leq 2\%$.
2. Repetitive Rating: pulse width limited by maximum junction temperature.
3. Device mounted on FR-4 PCB, 1inch x 0.85inch x 0.062inch, $t \leq 10$ sec.

Typical Electrical and Thermal Characteristic Curves

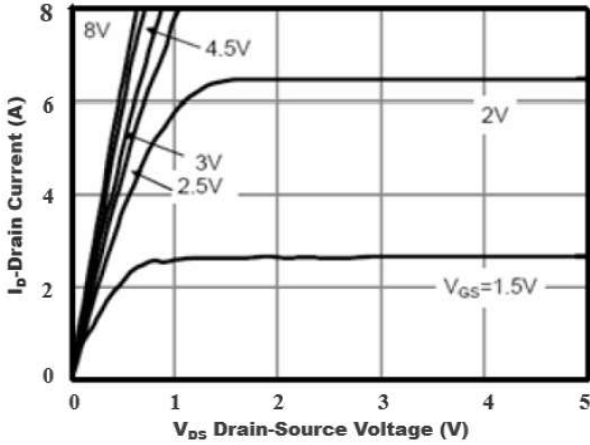

Figure 1. Typical Output Characteristics

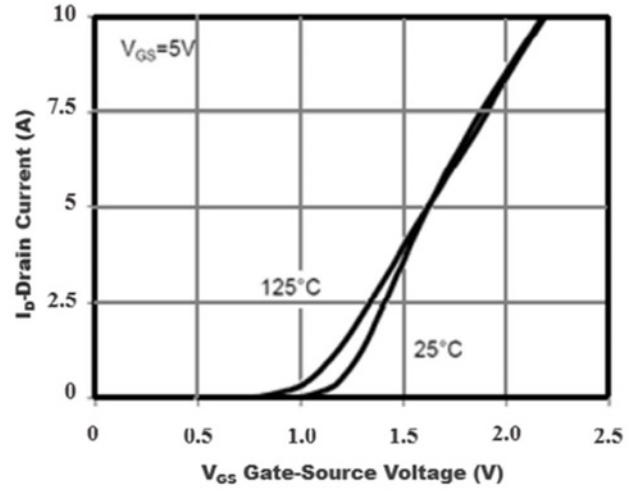

Figure 2. Transfer Characteristics

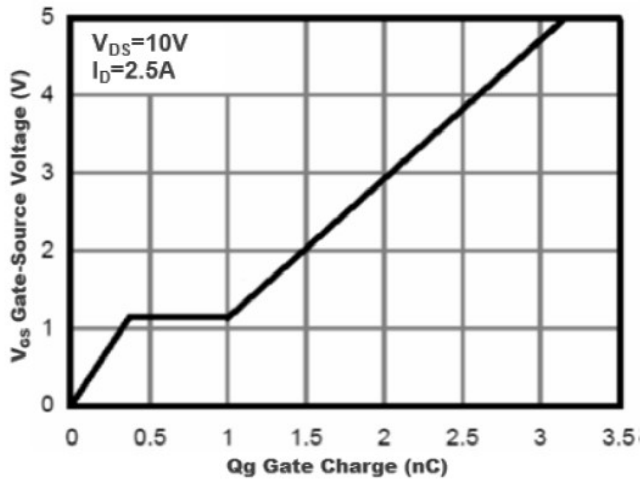

Figure 3. Gate Charge

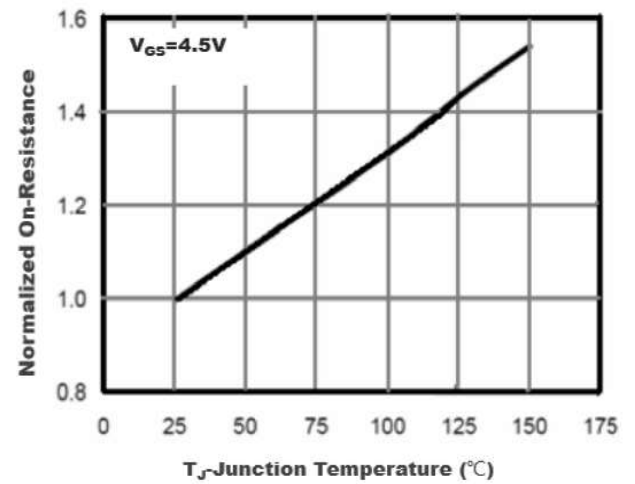

Figure 4. Normalized On-Resistance Vs. Junction Temperature

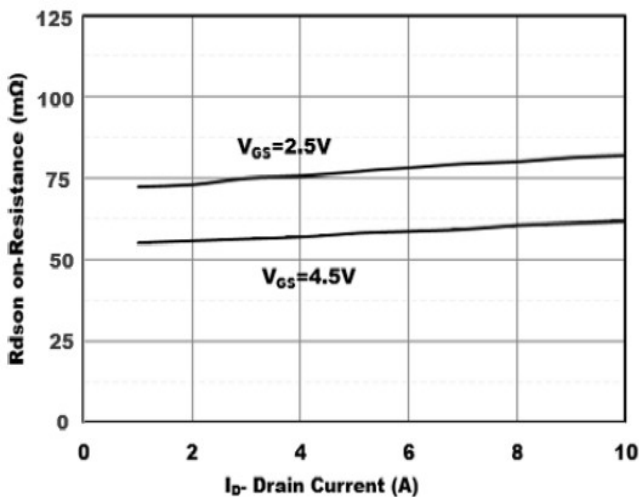

Figure 5. Drain-Source On-Resistance

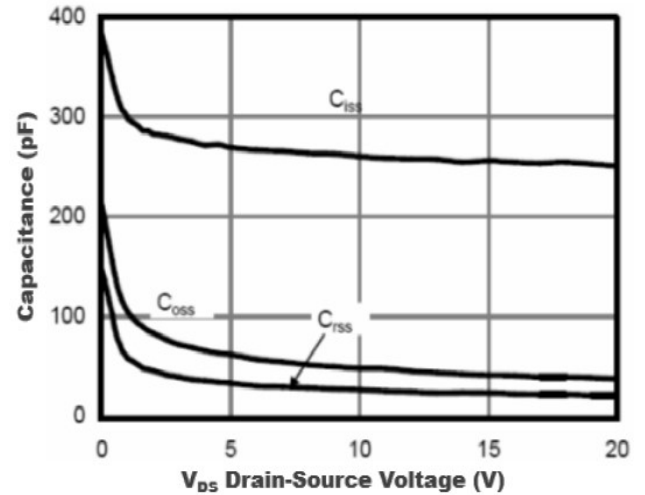

Figure 6. Typical Capacitance vs. Drain-to-Source Voltage

Typical Electrical and Thermal Characteristic Curves

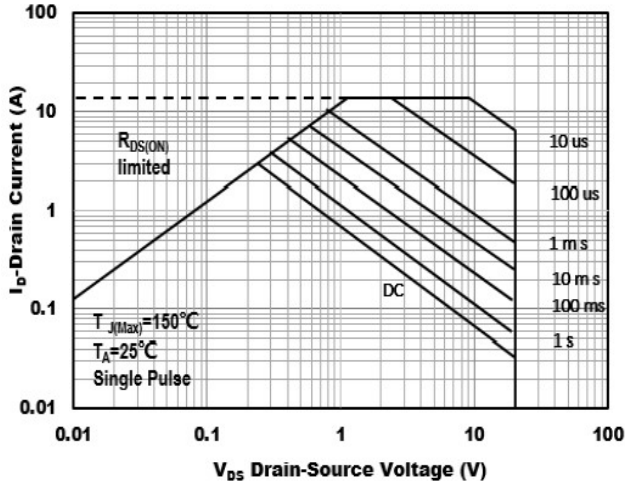

Figure 7. Safe Operation Area

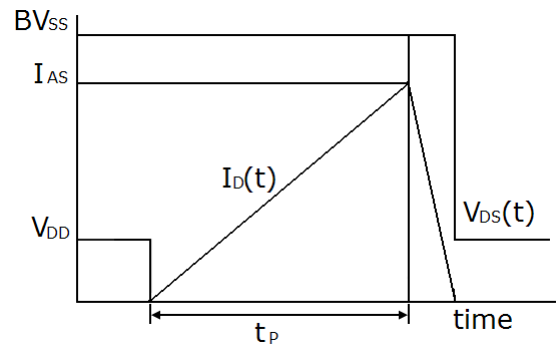
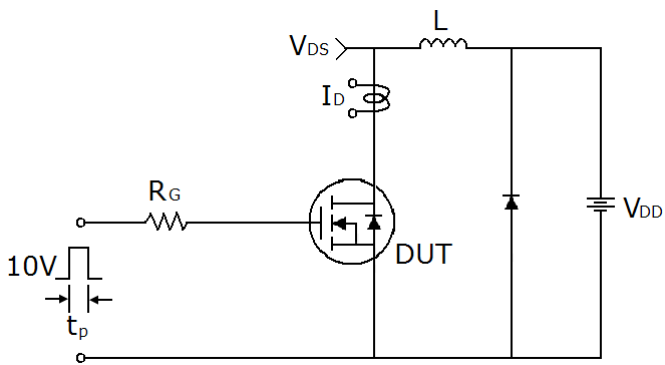

Figure 8. Unclamped Inductive Switching Test Circuit & Waveforms

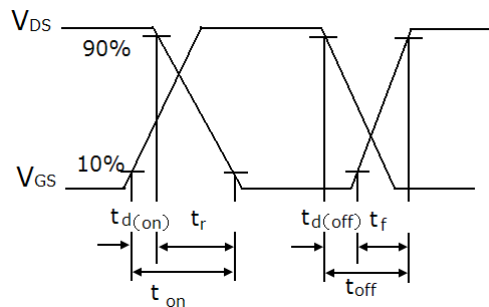
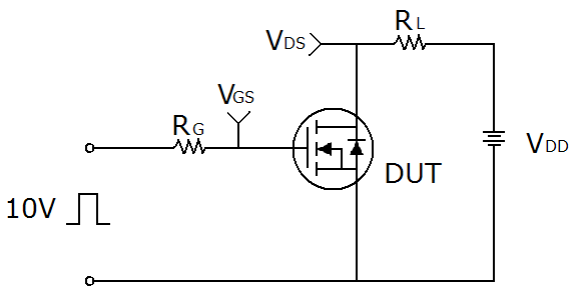

Figure 9. Resistive Switching Test Circuit & Waveforms

Typical Electrical and Thermal Characteristic Curves

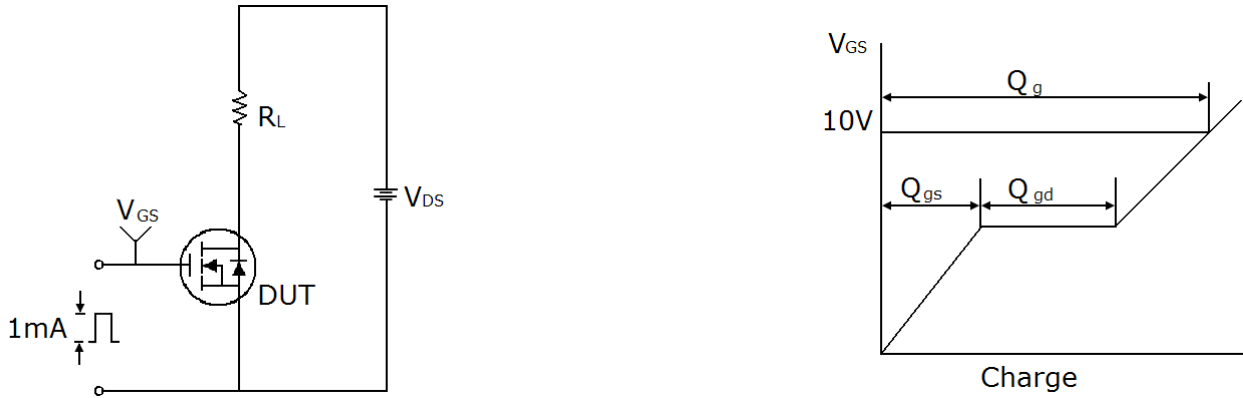
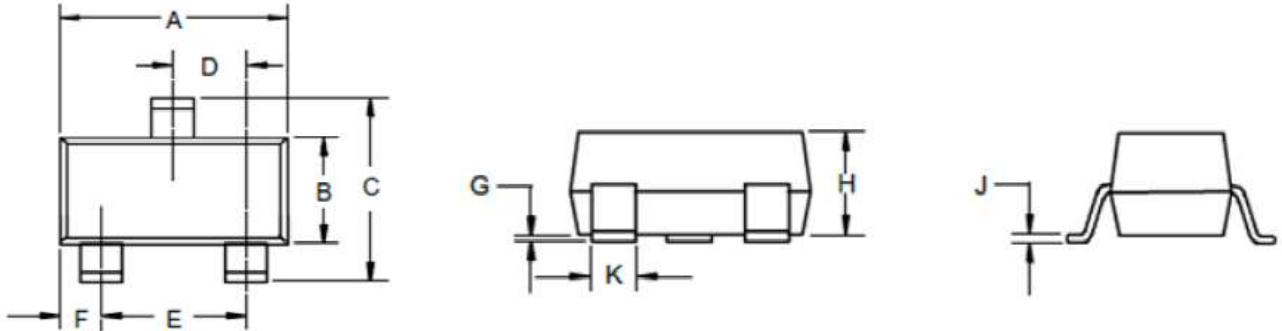

Figure 10. Gate Charge Test Circuit & Waveform

Package Outline Dimensions (SOT-323)



DIMENSIONS				
DIM	INCHES		MM	
	MIN	MAX	MIN	MAX
A	.071	.087	1.80	2.20
B	.045	.053	1.15	1.35
C	.083	.096	2.10	2.45
D	.026 Nominal		0.65Nominal	
E	.047	.055	1.20	1.40
F	.012	.016	.30	.40
G	.000	.004	.000	.100
H	.035	.039	.90	1.00
J	.004	.010	.100	.250
K	.006	.016	.15	.40

Recommended Pad Layout

