

ZXS-C2L4ZZDR-00-C

Tellabs® ZXS-C2L4ZZDR-00 Compatible TAA Compliant 100GBase-LR4 CFP2 Transceiver Dual-Rate (SMF, 1310nm, 10km, LC, DOM)

Features:

- CFP MSA 1.0 Compliance
- Duplex LC Connector
- Single-mode Fiber
- Commercial Temperature 0 to 70 Celsius
- Hot Pluggable
- Metal with Lower EMI
- Excellent ESD Protection
- RoHS Compliant and Lead Free



Applications:

- OTU4/100GBase Ethernet
- Access and Enterprise

Product Description

This Tellabs® ZXS-C2L4ZZDR-00 compatible CFP2 transceiver provides 100GBase/OTU4-LR4 throughput up to 10km over single-mode fiber (SMF) using a wavelength of 1310nm via an LC connector. It is guaranteed to be 100% compatible with the equivalent Tellabs® transceiver. This easy to install, hot swappable transceiver has been programmed, uniquely serialized and data-traffic and application tested to ensure that it will initialize and perform identically. Digital optical monitoring (DOM) support is also present to allow access to real-time operating parameters. This transceiver is Trade Agreements Act (TAA) compliant. We stand behind the quality of our products and proudly offer a limited lifetime warranty.

ProLabs' transceivers are RoHS compliant and lead-free.

TAA refers to the Trade Agreements Act (19 U.S.C. & 2501-2581), which is intended to foster fair and open international trade. TAA requires that the U.S. Government may acquire only "U.S. – made or designated country end products."



Absolute Maximum Ratings

Parameter	Symbol	Min.	Max.	Unit	Notes
Storage Temperature	TS	-40	+85	°C	
Power Supply Voltage	VCC	-0.5	3.6	V	
Operating Case Temperature Range	Tc	0	+70	°C	
Relative Humidity	Rh	5	85	%	
ESD			500	V	2

Notes:

1. Exceeding any one of these values may destroy the device immediately.
2. Human body model.

Electrical Characteristics

Parameter	Symbol	Min.	Typ.	Max.	Unit	Notes
Power Supply Voltage	VCC	3.2	3.3	3.4	V	
Power Consumption	P			6	W	
Transmitter						
Differential Input Amplitude	Vin			900	mVpp	AC coupled inputs
Input differential impedance	Zin	80	100	115	Ω	Rin > 100kohms @ DC
Receiver						
Differential output amplitude	Vout			900	mVpp	AC coupled outputs
Output differential impedance	Zoout	80	100	120	Ω	

1.2V MDIO Interface Specifications

Parameter	Symbol	Min.	Typ.	Max	Unit	Notes
Input Voltage	V _{IH}	0.84		1.5	V	
	V _{IL}	-0.3		0.36	V	
Input Leak current	I _{IN}	-100		100	uA	
Output Voltage	V _{OH}	1.0		1.5	V	
	V _{OL}	-0.3		0.2	V	
Input Capacitance	C _I			10	pF	
Input MDC Clock	f _{MDC}	0.1		4	MHz	
MDC Clock Period	T _{MDC}	250		10000	ns	
MDIO Hold Time	T _{hold}	10			ns	
MDIO Setup Time	T _{setup}	10			ns	
Clock to output delay from the MMD	T _{dely}	0		300	ns	
GLB_ALM	T _{glb_alm_ass}			150	ms	
	T _{glb_alm_dea}			150	ms	
MDC High time	T _{high}			160	ns	
MDC Low time	T _{low}			160	ns	

OTU4 Operation Optical Characteristics

Parameter	Symbol	Min.	Typical	Max.	Unit	Notes
Transmitter						
Signaling Speed per Lane	BRAVE		27.95		Gbps	
Data Rate Variation		-20		+20		
Lane_0 Center Wavelength	λ_{C0}	1294.53	1295.56	1296.59	nm	
Lane_1 Center Wavelength	λ_{C1}	1299.02	1300.05	1301.09	nm	
Lane_2 Center Wavelength	λ_{C2}	1303.54	1304.58	1305.63	nm	
Lane_3 Center Wavelength	λ_{C3}	1308.09	1309.14	1310.19	nm	
Total Average Output Power	PO1			8.9	dBm	1, 2
Average Launch Power per Lane	Peach1	-2.5		2.9	dBm	2
Maximum channel power difference				5	dB	
Side Mode Suppression Ratio	SMSR	30			dB	
Optical Return Loss Tolerance				20	dB	2
Extinction Ratio	ER1	7			dB	
Transmitter eye mask definition {X1, X2, X3, Y1, Y2, Y3}		G.959.1 Compliant				2
Optical Eye Mask Margin	MM	5			%	3
TX Disable Assert Time	t_off			100	us	
Receiver						
Signaling Speed per Lane	BRAVE		27.95		Gbps	
Data Rate Variation		-20		+20	ppm	
Lane_0 Center Wavelength	λ_{C0}	1294.53	1295.56	1296.59	nm	
Lane_1 Center Wavelength	λ_{C1}	1299.02	1300.05	1301.09	nm	
Lane_2 Center Wavelength	λ_{C2}	1303.54	1304.58	1305.63	nm	
Lane_3 Center Wavelength	λ_{C3}	1308.09	1309.14	1310.19	nm	
Average Receive Power per Lane	Rpow1	-8.8		2.9	dBm	4
Equivalent Sensitivity per Lane	Pmin1			-10.3	dBm	5
Damage Threshold per Lane	Pmax	5.5			dBm	
Maximum channel power difference				5.5	dB	
Maximum optical path penalty				1.5	dB	
Optical Return Loss	ORL			-26	dB	
LOS Assert	LOSA	-21	-17	-16	dBm	
LOS De-Assert	LOSD		-16	-15	dBm	
LOS Hysteresis		0.5			dB	

Notes:

1. Output is coupled into a 9/125µm single-mode fiber.
2. Filtered, measured with a PRBS 2³¹-1 test pattern @27.95Gbps
3. Eye Margin within 1000 waveforms.
4. CFP2 transceiver works in OTU4 411-9D1F mode.
5. Minimum average optical power measured at BER less than 1E-12, with a 2³¹-1 PRBS@27.95Gbps.

100GBASE-LR4 Operation Optical Characteristics

Parameter	Symbol	Min.	Typical	Max.	Unit	Notes	
Transmitter							
Signaling Speed per Lane	BRAVE		25.78		Gbps		
Data Rate Variation		-100		+100	ppm		
Lane_0 Center Wavelength	λC0	1294.53	1295.56	1296.59	nm		
Lane_1 Center Wavelength	λC1	1299.02	1300.05	1301.09	nm		
Lane_2 Center Wavelength	λC2	1303.54	1304.58	1305.63	nm		
Lane_3 Center Wavelength	λC3	1308.09	1309.14	1310.19	nm		
Total Average Output Power	PO2	-		10.5	dBm	1, 2	
Average Launch Power per Lane	Peach2	-4.3		4.5	dBm	2	
Side Mode Suppression Ratio	SMSR	30			dB		
Difference in launch power between any two lanes				5	dB		
Average launch power of OFF transmitter per lane				-30	dBm		
Optical Return Loss Tolerance				20	dB		
Transmitter reflectance				-12	dB		
Extinction Ratio	ER	4			dB	2	
Transmitter eye mask definition {X1, X2, X3, Y1, Y2, Y3}		IEEE802.3ba-2010 Compliant					2
Optical Eye Mask Margin	MM	5			%	3	
TX Disable Assert Time	t_off			100	us		
Receiver							
Signaling Speed per Lane	BRAVE		25.78		Gbps		
Data Rate Variation		-100		+100	ppm		
Lane_0 Center Wavelength	λC0	1294.53	1295.56	1296.59	nm		
Lane_1 Center Wavelength	λC1	1299.02	1300.05	1301.09	nm		
Lane_2 Center Wavelength	λC2	1303.54	1304.58	1305.63	nm		
Lane_3 Center Wavelength	λC3	1308.09	1309.14	1310.19	nm		
Average Receive Power per Lane	Rpow2	-10.6		4.5	dBm	4	
Receive Sensitivity (OMA) per lane	Pmin2			-8.6	dBm	5	

Stressed Sensitivity (OMA) per lane	SRS				-6.8	dBm	
Damage Threshold per Lane	Pmax	5.5				dBm	
Optical Return Loss	ORL				-26	dB	
LOS Assert	LOSA	-21	-17	-16		dBm	
LOS De-Assert	LOSD		-16	-15		dBm	
LOS Hysteresis		0.5				dB	6

Notes:

1. Output is coupled into a 9/125µm single-mode fiber.
2. Filtered, measured with a PRBS 2³¹-1 test pattern @25.78Gbps
3. Eye Margin within 1000 waveforms.
4. CFP2 transceiver works in 100GBASE-LR4 mode
5. Minimum average optical power measured at BER less than 1E-12, with a 2³¹-1 PRBS@25.78Gbps.
6. LOS Hysteresis

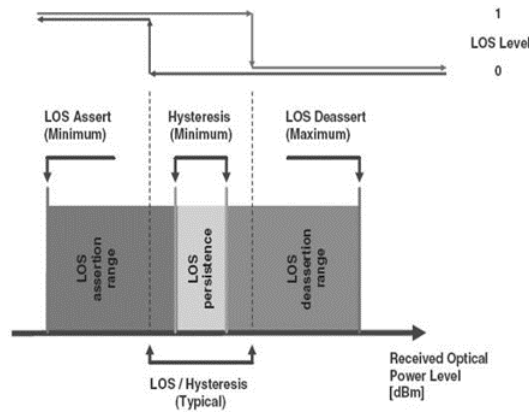

Functional Description of Transceiver

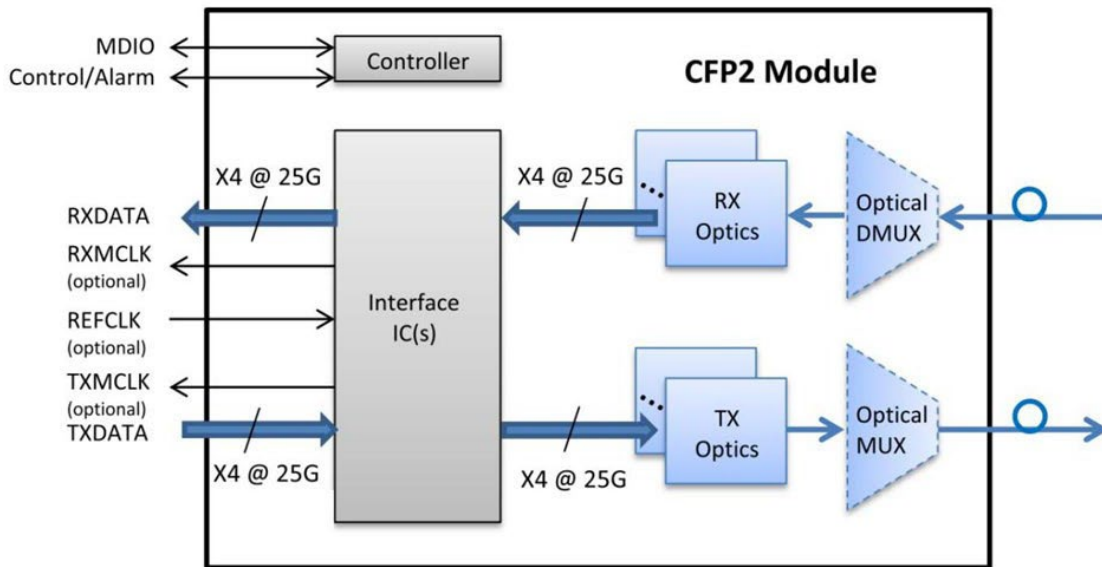

Electrical Pad Layout

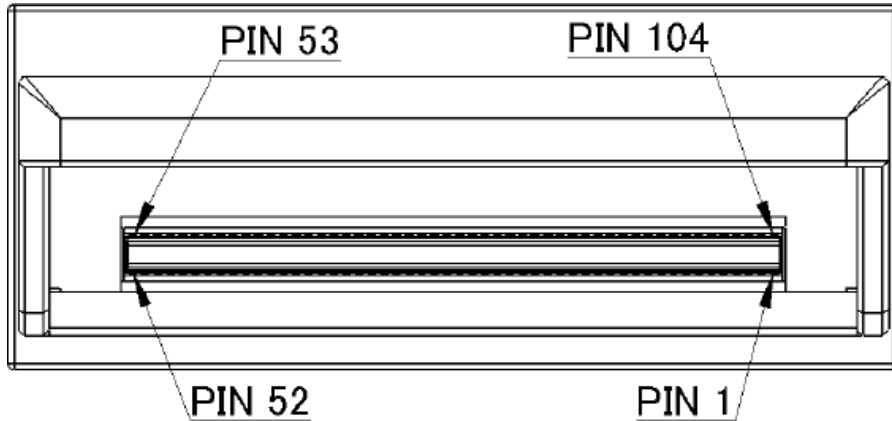

Pin Descriptions

Part A: Bottom Row Pin Function Definition

Pin	Name	Function	Notes
1	GND		
2	(TX_MCK_N)	O CML	For optical waveform testing. Not for normal use.
3	(TX_MCK_P)	O CML	For optical waveform testing. Not for normal use.
4	GND		
5	N.C.		
6	N.C.		
7	3.3V_GND		
8	3.3V_GND		
9	3.3V		3.3V Module Supply Voltage
10	3.3V		3.3V Module Supply Voltage
11	3.3V		3.3V Module Supply Voltage
12	3.3V		3.3V Module Supply Voltage
13	3.3V_GND		
14	3.3V_GND		
15	VND_IO_A		Module Vendor I/O A. Do not connect!
16	VND_IO_B		Module Vendor I/O B. Do not connect!
17	PRG_CNTL1		Programmable control 1 set over MDIO, MSA default: TRXIC_RSTn. TX&RX ICs reset. "0": reset; "1" or NC: enabled = not used
18	PRG_CNTL2		Programmable Control 2 set over MDIO, MSA Default: Hardware Interlock LSB, "00": ≤3W, "01": ≤6W, "10": ≤9W, "11" or NC: ≤12W = not used
19	PRG_CNTL3		Programmable Control 3 set over MDIO, MSA Default: Hardware Interlock MSB, "00": ≤3W, "01": ≤6W, "10": ≤9W, "11" or NC: ≤12W = not used
20	PRG_ALARM1		Programmable alarm 1 set over MDIO, MSA default: HIPWR_ON. "1": module power up completed; "0": module not high powered up.
21	PRG_ALARM2		Programmable alarm 2 set over MDIO, MSA default: MOD_READY. "1": ready; "0": not ready.
22	PRG_ALARM3		Programmable alarm 3 set over MDIO, MSA default: MOD_FAULT, fault detected. "1": fault; "0": not fault.
23	GND		
24	TX_DIS	I LVCMOS	Transmitter disable for all lanes. "1" or NC: transmitter disabled; "0": transmitter enabled.

25	RX_LOS	O LVCMOS	Receiver loss of optical signal. "1": low optical signal; "0": normal condition.
26	MOD_LOPWR	I LVCMOS	Module Low power mode. "1" or NC: module in low power (safe) mode; "0": power-on enabled.
27	MOD_ABS	O GND	Module Absent. "1" or NC: module absent; "0": module present. Pull up resistor on Host.
28	MOD_RSTn	I LVCMOS	Module Reset. "0": resets the module; "1" or NC: module enabled. Pull Down Resistor in module.
29	GLB_ALRMn	O LVCMOS	Global Alarm. "0": alarm condition in any MDIO alarm register; "1": no alarm condition. Open Drain, Pull up resistor on Host
30	GND		
31	MDC	I 1.2V CMOS	Management Data Clock
32	MDIO	I/O 1.2V CMOS	Management Data I/O bi-directional data
33	PRTADR0	I 1.2V CMOS	MDIO Physical Port address bit 0
34	PRTADR1	I 1.2V CMOS	MDIO Physical Port address bit 1
35	PRTADR2	I 1.2V CMOS	MDIO Physical Port address bit 2
36	VND_IO_C	I/O	Module Vendor I/O C. Do not connect!
37	VND_IO_D	I/O	Module Vendor I/O D. Do not connect!
38	VND_IO_E	I/O	Module Vendor I/O E. Do not connect!
39	3.3V_GND		
40	3.3V_GND		
41	3.3V		3.3V Module Supply Voltage
42	3.3V		3.3V Module Supply Voltage
43	3.3V		3.3V Module Supply Voltage
44	3.3V		3.3V Module Supply Voltage
45	3.3V_GND		
46	3.3V_GND		
47	N.C.		No Connect
48	N.C.		No Connect
49	GND		
50	(RX_MCK_N)	O CML	For optical waveform testing. Not for normal use.
51	(RX_MCK_P)	O CML	For optical waveform testing. Not for normal use.
52	GND		

Part B: Top Row Pin Function Definition

Pin	Name	Function	Notes
53	GND		
54	N.C.		
55	N.C.		
56	GND		
57	RX0p	Lane 0 Rx Output O	CML Output
58	RX0n	Lane 0 Rx Output O	CML Output
59	GND		
60	RX1p	Lane 1 Rx Output O	CML Output
61	RX1n	Lane 1 Rx Output O	CML Output
62	GND		
63	N.C.		
64	N.C.		

65	GND		
66	N.C.		
67	N.C.		
68	GND		
69	RX2p	Lane 2 Rx Output O	CML Output
70	RX2n	Lane 2 Rx Output O	CML Output
71	GND		
72	RX3p	Lane 3 Rx Output O	CML Output
73	RX3n	Lane 3 Rx Output O	CML Output
74	GND		
75	N.C.		
76	N.C.		
77	GND		
78	(REFCLKn)	Reference Clock I	Reference Clock Input
79	(REFCLKp)	Reference Clock I	Reference Clock Input
80	GND		
81	N.C.		
82	N.C.		
83	GND		
84	TX0p	Lane 0 Tx Input I	CML Input
85	TX0n	Lane 0 Tx Input I	CML Input
86	GND		
87	TX1p	Lane 1 Tx Input I	CML Input
88	TX1n	Lane 1 Tx Input I	CML Input
89	GND		
90	N.C.		
91	N.C.		
92	GND		
93	N.C.		
94	N.C.		
95	GND		
96	TX2p	Lane 2 Tx Input I	CML Input
97	TX2n	Lane 2 Tx Input I	CML Input
98	GND		
99	TX3p	Lane 3 Tx Input I	CML Input
100	TX3n	Lane 3 Tx Input I	CML Input
101	GND		
102	N.C.		
103	N.C.		
104	GND		

Mechanical Specifications

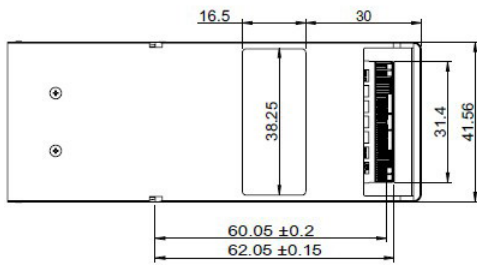
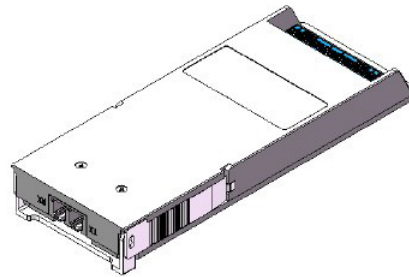
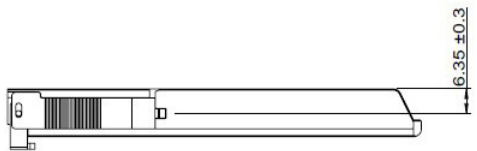
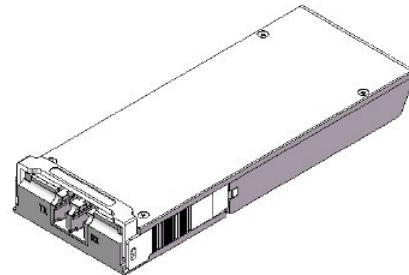
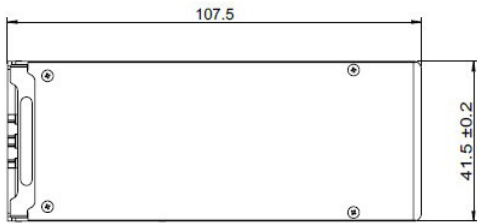
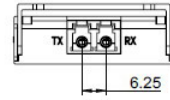
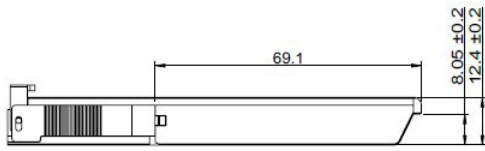

About ProLabs

Our experience comes as standard; for over 15 years ProLabs has delivered optical connectivity solutions that give our customers freedom and choice through our ability to provide seamless interoperability. At the heart of our company is the ability to provide state-of-the-art optical transport and connectivity solutions that are compatible with over 90 optical switching and transport platforms.

Complete Portfolio of Network Solutions

ProLabs is focused on innovations in optical transport and connectivity. The combination of our knowledge of optics and networking equipment enables ProLabs to be your single source for optical transport and connectivity solutions from 100Mb to 400G while providing innovative solutions that increase network efficiency. We provide the optical connectivity expertise that is compatible with and enhances your switching and transport equipment.

Trusted Partner

Customer service is our number one value. ProLabs has invested in people, labs and manufacturing capacity to ensure that you get immediate answers to your questions and compatible product when needed. With Engineering and Manufacturing offices in the U.K. and U.S. augmented by field offices throughout the U.S., U.K. and Asia, ProLabs is able to be our customers best advocate 24 hours a day.



Contact Information

ProLabs US

Email: sales@prolabs.com

Telephone: 952-852-0252

ProLabs UK

Email: salessupport@prolabs.com

Telephone: +44 1285 719 600