

400mA Sub-Miniature Adjustable DC-DC Converter Optimized for RF Power Amplifiers

General Description

The LM2614 DC-DC converter is optimized for powering RF power amplifiers (PAs) from a single Lithium-Ion cell. It steps down an input voltage of 2.8V to 5.5V to an output of 1.0V to 3.6V at up to 400mA (300mA for B grade). Output voltage is set using an analog input to VCON in the application circuit.

The device offers three modes for mobile phones and similar RF PA applications. Fixed-frequency PWM mode minimizes RF interference. A SYNC input allows synchronizing the switching frequency in a range of 500kHz to 1MHz. Low current hysteretic PFM mode reduces quiescent current to 160 μ A (typ.). Shutdown mode turns the device off and reduces battery consumption to 0.02 μ A (typ.).

Current limit and thermal shutdown features protect the device and system during fault conditions.

The LM2614 is available in a 10 bump micro SMD package. This packaging uses National's chip-scale micro SMD technology and offers the smallest possible size. A high switching frequency (600kHz) allows use of tiny surface-mount components.

The LM2614 can be dynamically controlled for output voltage changes from 1.0V to 3.6V in <30 μ s. The device features external compensation to tailor the response to a wide range of operating conditions.

Key Specifications

- Operates from a single LiION cell (2.8V to 5.5V)
- Adjustable output voltage (1.0V to 3.6V)
- $\pm 1\%$ DC feedback voltage precision
- 400mA maximum load capability(300mA for B grade)
- 600 μ A typ PWM mode quiescent current
- 0.02 μ A typ shutdown current
- 600kHz PWM switching frequency
- SYNC input for PWM mode frequency synchronization from 500kHz to 1MHz
- High efficiency (96% typ at 3.9V_{IN}, 3.6V_{OUT} and 200mA) in PWM mode from internal synchronous rectification
- 100% Maximum Duty Cycle for Lowest Dropout

Features

- Sub-miniature 10-bump thin micro SMD package
- Uses small ceramic capacitors
- 5mV typ PWM mode output voltage ripple(C_{OUT} = 22 μ F)
- Internal soft start
- Current overload protection
- Thermal Shutdown
- External compensation

Applications

- Mobile Phones
- Hand-Held Radios
- RF PC Cards
- Battery Powered RF Devices

Typical Application Circuits

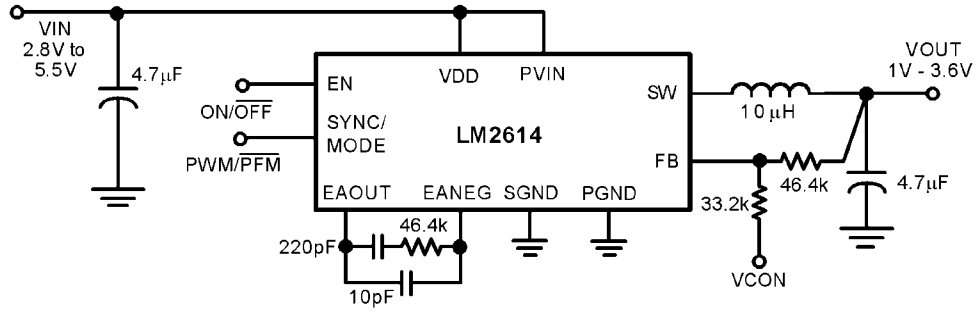

20036701

FIGURE 1. Typical Circuit for Powering RF Power Amplifiers

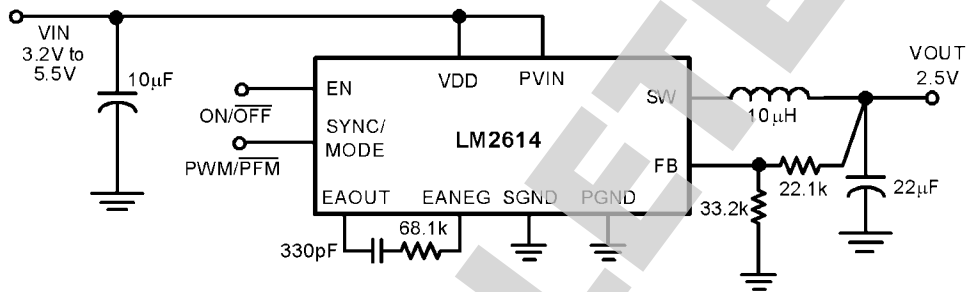

20036702

FIGURE 2. Typical Circuit for 2.5V Output Voltage

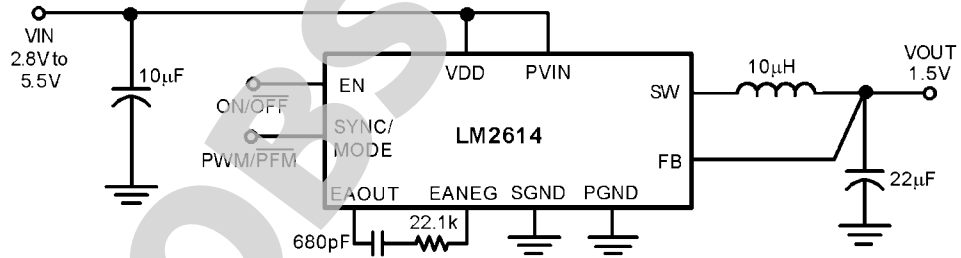

20036703

FIGURE 3. Typical Circuit for 1.5V Output Voltage

Connection Diagrams

10-Bump micro SMD Package

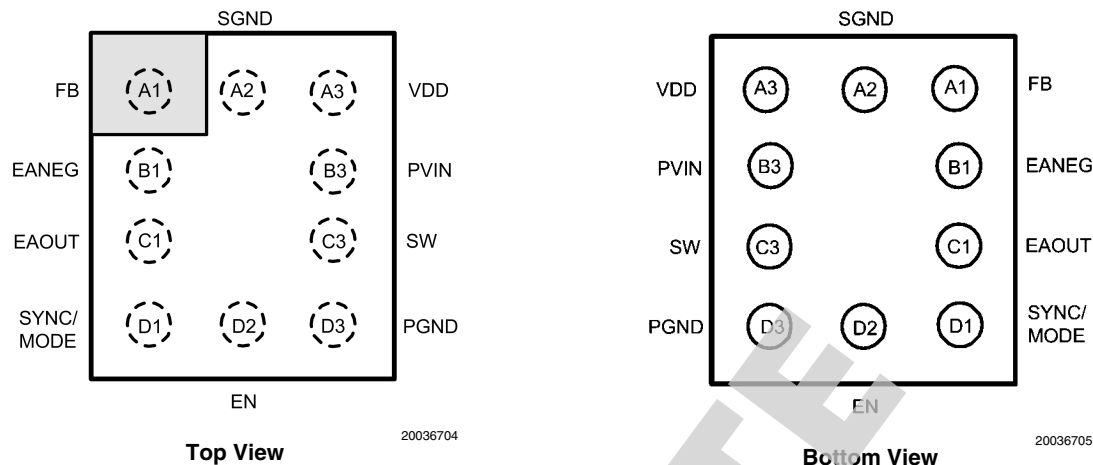

Ordering Information

Order Number	Package Type	NSC Package Marking (*)	Supplied As
LM2614ATL	10-bump Wafer Level Chip Scale (micro SMD)	XYTT S50A	250 Tape and Reel
LM2614BTL		XYTT S50B	250 Tape and Reel
LM2614ATLX		XYTT S50A	3000 Tape and Reel
LM2614BTLX		XYTT S50B	3000 Tape and Reel

(*) XY - denotes the date code marking (2 digit) in production

(*) TT - refers to die run/lot traceability for production

(*) S - product line designator

Package markings may change over the course of production.

Pin Descriptions

Pin Number	Pin Name	Function
A1	FB	Feedback Analog Input.
B1	EANEG	Inverting input of error amplifier
C1	EAOUT	Output of error amplifier
D1	SYNC/MODE	Synchronization Input. Use this digital input for frequency selection or modulation control. Set: SYNC/MODE = high for low-noise 600kHz PWM mode SYNC/MODE = low for low-current PFM mode SYNC/MODE = a 500kHz–1MHz external clock for synchronization in PWM mode. (See <i>Synchronization and Operating Modes</i> in the <i>Device Information</i> section.)
D2	EN	Enable Input. Set this Schmitt trigger digital input high for normal operation. For shutdown, set low. Set EN low during system power-up and other low supply voltage conditions. (See <i>Shutdown Mode</i> in the <i>Device Information</i> section.)
D3	PGND	Power Ground
C3	SW	Switching Node connection to the internal PFET switch and NFET synchronous rectifier. Connect to an inductor with a saturation current rating that exceeds the max Switch Peak Current Limit of the LM2614.
B3	PVIN	Power Supply Voltage Input to the internal PFET switch. Connect to the input filter capacitor.
A3	VDD	Analog Supply Input. If board layout is not optimum, an optional 0.1µF ceramic capacitor is suggested.
A2	SGND	Analog and Control Ground

Absolute Maximum Ratings *(Note 1)*

If Military/Aerospace specified devices are required, please contact the National Semiconductor Sales Office/Distributors for availability and specifications.

PVIN, VDD to SGND	-0.2V to +6V
PGND to SGND, PVIN to VDD	-0.2V to +0.2V
EN, EAOUT, EANEG, SYNC/MODE to SGND	-0.2V to +6V
FB, SW	(GND -0.2V) to (VDD +0.2V)

Storage Temperature Range	-45°C to +150°C
Lead Temperature (Soldering, 10 sec.)	260°C
Junction Temperature <i>(Note 2)</i>	-25°C to +125°C
Minimum ESD Rating (Human Body Model, C = 100 pF, R = 1.5 kΩ)	±2 kV
Thermal Resistance (θ_{JA}) <i>(Note 3)</i>	140°C/W

Electrical Characteristics

Specifications with standard typeface are for $T_A = T_J = 25^\circ\text{C}$, and those in **boldface type** apply over the full **Operating Temperature Range** of $T_A = T_J = -25^\circ\text{C}$ to $+85^\circ\text{C}$. Unless otherwise specified, PVIN = VDD = EN = SYNC/MODE = 3.6V.

Symbol	Parameter	Conditions	Min	Typ	Max	Units
V_{IN}	Input Voltage Range	PVIN = VDD = V_{IN} <i>(Note 4)</i>	2.8	3.6	5.5	V
V_{FB}	Feedback Voltage		1.485	1.50	1.515	V
V_{HYST}	PFM Comparator Hysteresis Voltage	PFM Mode (SYNC/MODE = 0V) <i>(Note 5)</i>		24		mV
I_{SHDN}	Shutdown Supply Current	VIN = 3.6V, EN = 0V		0.02	3	μA
I_{Q1_PWM}	DC Bias Current into VDD	SYNC/MODE = VIN FB = 2V		600	725	μA
I_{Q2_PFM}		SYNC/MODE = 0V FB = 2V		160	195	μA
$R_{DSON(P)}$	Pin-Pin Resistance for P FET			395	550	mΩ
$R_{DSON(N)}$	Pin-Pin Resistance for N FET			330	500	mΩ
$R_{DSON(TC)}$	FET Resistance Temperature Coefficient			0.5		%/C
I_{LIM}	Switch Peak Current Limit <i>(Note 6)</i>	LM2614ATL	510	690	850	mA
		LM2614BTL	400	690	980	
V_{IH}	Logic High Input, EN, SYNC/MODE			0.95	1.3	V
V_{IL}	Logic Low Input, EN, SYNC/MODE		0.4	0.80		V
F_{SYNC}	SYNC/MODE Clock Frequency Range	<i>(Note 7)</i>	500		1000	kHz
F_{OSC}	Internal Oscillator Frequency	LM2614ATL, PWM Mode	468	600	732	kHz
		LM2614BTL, PWM Mode	450	600	750	
T_{min}	Minimum ON-Time of PFET Switch in PWM Mode			200		ns

Note 1: Absolute Maximum Ratings indicate limits beyond which damage to the device may occur. Operating Ratings indicate conditions for which the device is functional, but device specifications may not be guaranteed. For guaranteed specifications and associated test conditions, see the Min and Max limits and Conditions in the Electrical Characteristics table. Typical (typ) specifications are mean or average values at 25°C and are not guaranteed.

Note 2: Thermal shutdown will occur if the junction temperature exceeds 150°C.

Note 3: Thermal resistance specified with 2 layer PCB (0.5/0.5 oz. cu).

Note 4: The LM2614 is designed for mobile phone applications where turn-on after system power-up is controlled by the system controller. Thus, it should be kept in shutdown by holding the EN pin low until the input voltage exceeds 2.8V.

Note 5: The hysteresis voltage is the minimum voltage swing on the FB pin that causes the internal feedback and control circuitry to turn the internal PFET switch on and then off during PFM mode. When resistor dividers are used like in the operating circuit of [Figure 4](#), the hysteresis at the output will be the value of the hysteresis at the feedback pin times the resistor divider ratio. In this case, 24mV (typ) x ((46.4k + 33.2k)/33.2k).

Note 6: Current limit is built-in, fixed, and not adjustable. If the current limit is reached while the voltage at the FB pin is pulled below 0.7V, the internal PFET switch turns off for 2.5μs to allow the inductor current to diminish.

Note 7: SYNC driven with an external clock switching between V_{IN} and GND. When an external clock is present at SYNC; the IC is forced to be in PWM mode at the external clock frequency. The LM2614 synchronizes to the rising edge of the external clock.

Typical Performance Characteristics

LM2614ATL, Circuit of [Figure 4](#), $V_{IN} = 3.6V$, $T_A = 25^\circ C$, unless otherwise noted.

Quiescent Supply Current vs Supply Voltage

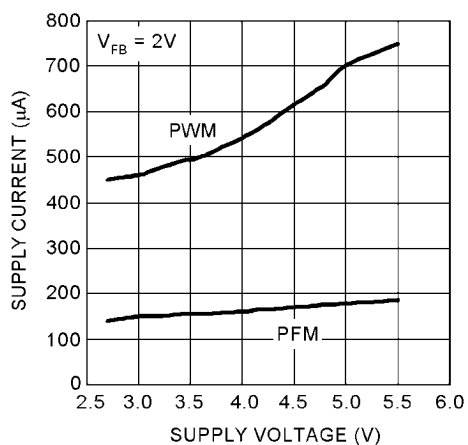

20036708

**Shutdown Quiescent Current vs Temperature
(Circuit in [Figure 3](#))**

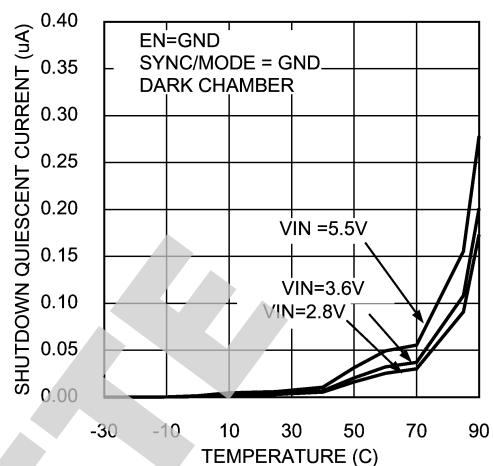

20036722

**Output Voltage vs Supply Voltage
($V_{OUT} = 1.0V$, PWM MODE)**

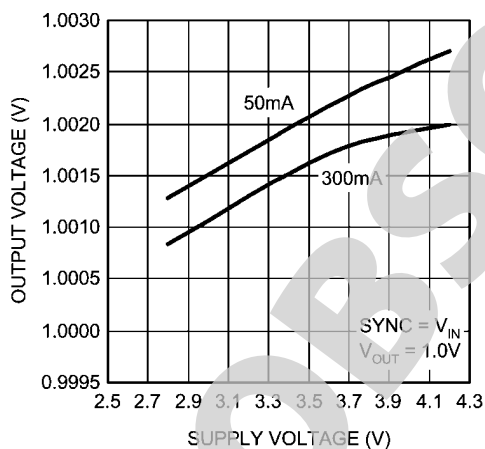

20036724

**Output Voltage vs Supply Voltage
($V_{OUT} = 1.5V$, PWM MODE)**

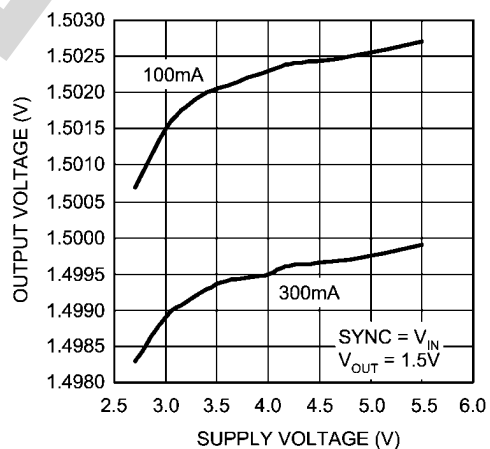

20036709

Output Voltage vs Output Current
($V_{OUT} = 1.0V$, PWM MODE)

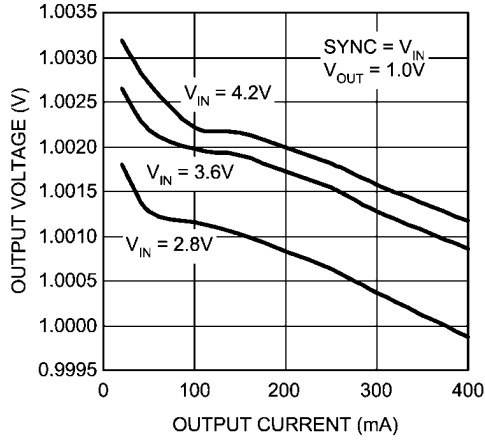

20036710

Output Voltage vs Output Current
($V_{OUT} = 1.5V$, PWM MODE)

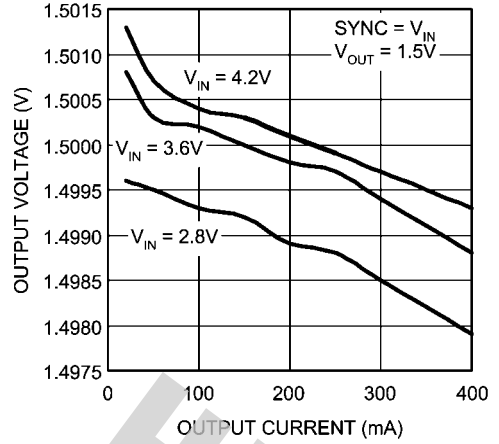

20036711

Output Voltage vs Output Current
($V_{OUT} = 3.6V$, PWM MODE)

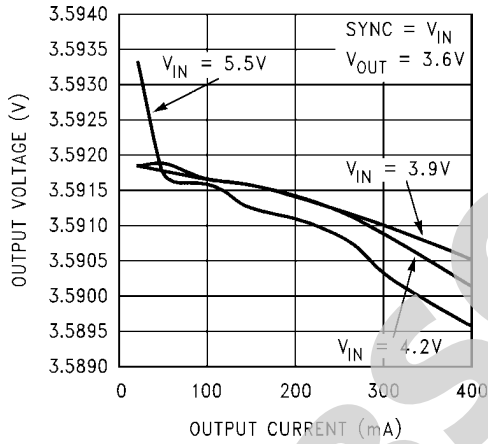

20036732

Dropout Voltage vs Output Current
($V_{OUT} = 3.6V$, PWM MODE)

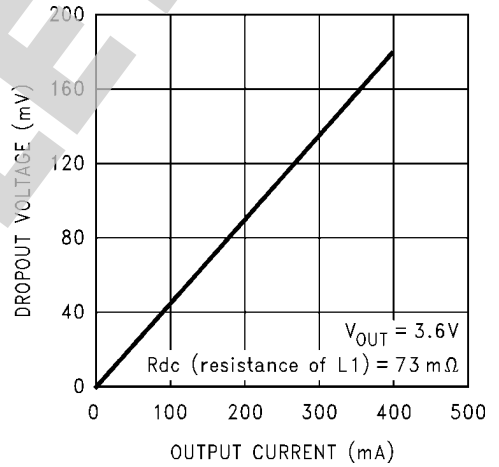

20036712

Switching Frequency vs Temperature
(Circuit in *Figure 3*, PWM MODE)

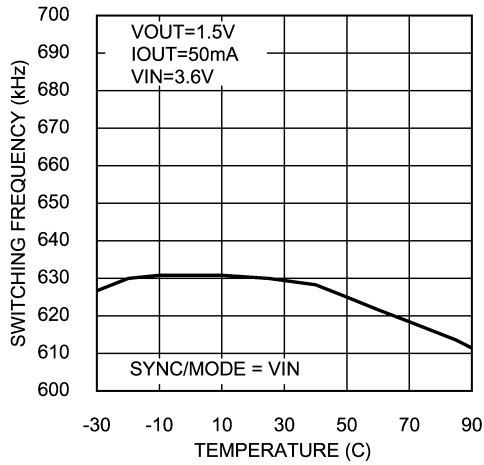

20036723

Feedback Bias Current vs Temperature
(Circuit in *Figure 3*)

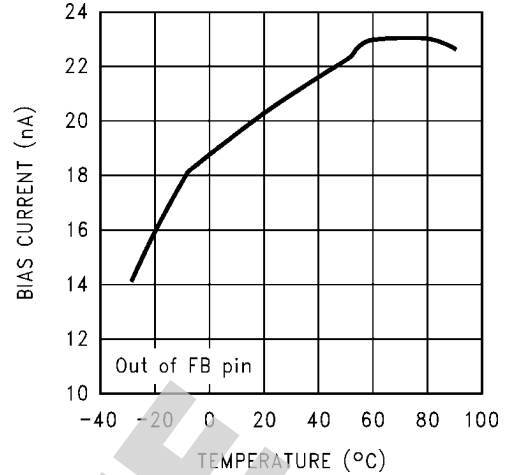

20036731

Efficiency vs Output Current
($V_{OUT} = 1.0V$, PWM MODE)

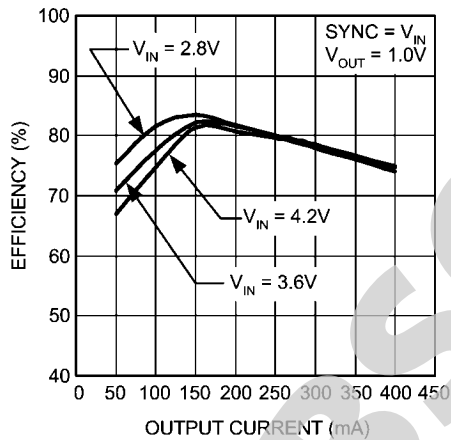

20036713

Efficiency vs Output Current
($V_{OUT} = 1.0V$, PWM MODE, with Diode)

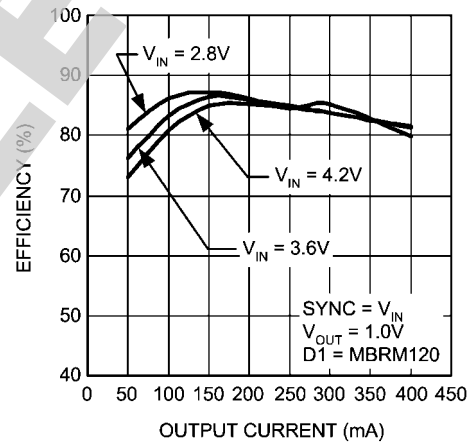

20036714

**Efficiency vs Output Current
($V_{OUT} = 1.5V$, PWM MODE)**

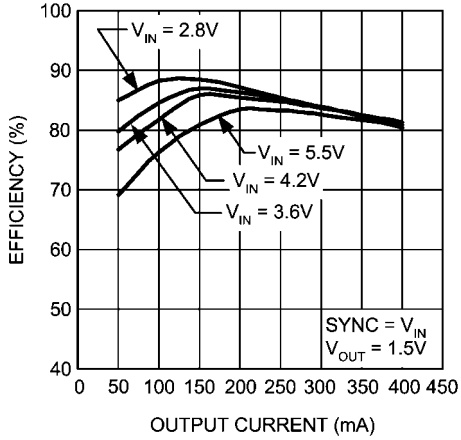

**Efficiency vs Output Current
($V_{OUT} = 1.5V$, PWM MODE, with Diode)**

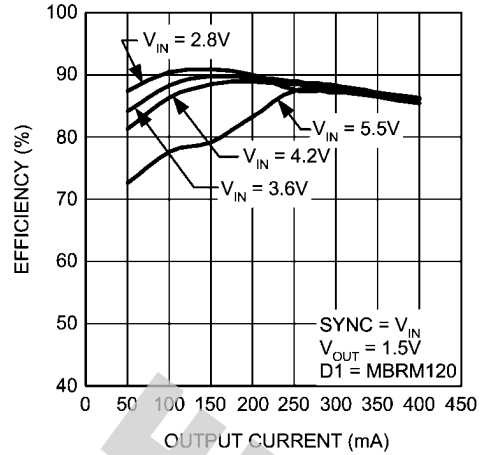

**Efficiency vs Output Current
($V_{OUT} = 3.6V$, PWM MODE)**

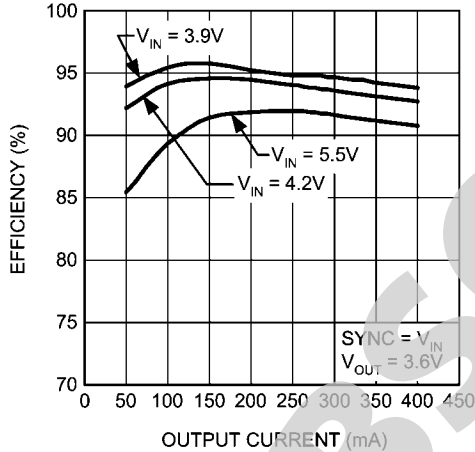

**Efficiency vs Output Current
($V_{OUT} = 3.6V$, PWM MODE, with Diode)**

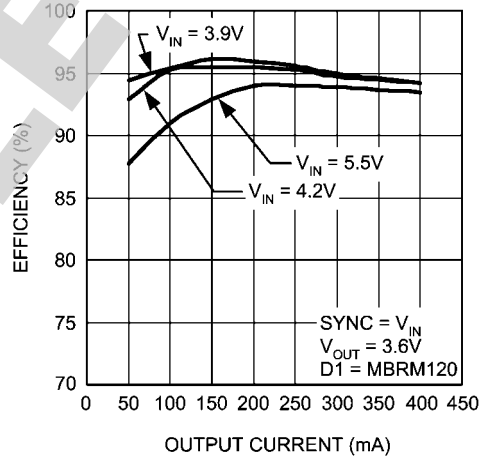

**Efficiency vs Output Voltage
(PWM MODE, with Diode)**

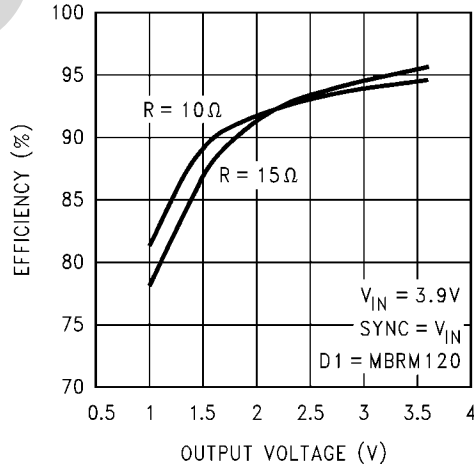

Device Information

The LM2614 is a simple, step-down DC-DC converter optimized for powering RF power amplifiers (PAs) in mobile phones, portable communicators, and similar battery powered RF devices. It is designed to allow the RF PA to operate at maximum efficiency over a wide range of power levels from a single LiION battery cell. It is based on a current-mode buck architecture, with synchronous rectification in PWM mode for high efficiency. It is designed for a maximum load capability of 400mA (300mA for B grade) in PWM mode. Maximum load range may vary from this depending on input voltage, output voltage and the inductor chosen.

The device has all three of the pin-selectable operating modes required for powering RF PAs in mobile phones and other sophisticated portable devices with complex power management needs. Fixed-frequency PWM operation offers full output current capability at high efficiency while minimizing interference with sensitive IF and data acquisition circuits. During standby operation, hysteretic PFM mode reduces quiescent current to 160 μ A typ. to maximize battery life. Shutdown mode turns the device off and reduces battery consumption to 0.02 μ A (typ).

DC PWM mode feedback voltage precision is $\pm 1\%$. Efficiency is typically 96% for a 200mA load with 3.6V output, 3.9V input.

The efficiency can be further increased by using a schottky diode like MBRM120 as shown in [Figure 4](#). PWM mode quiescent current is 600 μ A typ. The output voltage is dynamically programmable from 1.0V to 3.6V by adjusting the voltage on the VCON at the external feedback resistors. This ensures longer battery life by being able to change the PA supply voltage dynamically depending on its transmitting power.

Additional features include soft-start, current overload protection, over voltage protection and thermal shutdown protection.

The LM2614 is constructed using a chip-scale 10-pin thin micro SMD package. This package offers the smallest possible size, for space-critical applications such as cell phones, where board area is an important design consideration. Use of a high switching frequency (600kHz) reduces the size of external components. Board area required for implementation is only 0.58in² (375mm²).

Use of a micro-SMD package requires special design considerations for implementation. (See *Micro SMD Package Assembly and Use* in the *Application Information* section.) Its fine bump-pitch requires careful board design and precision assembly equipment.

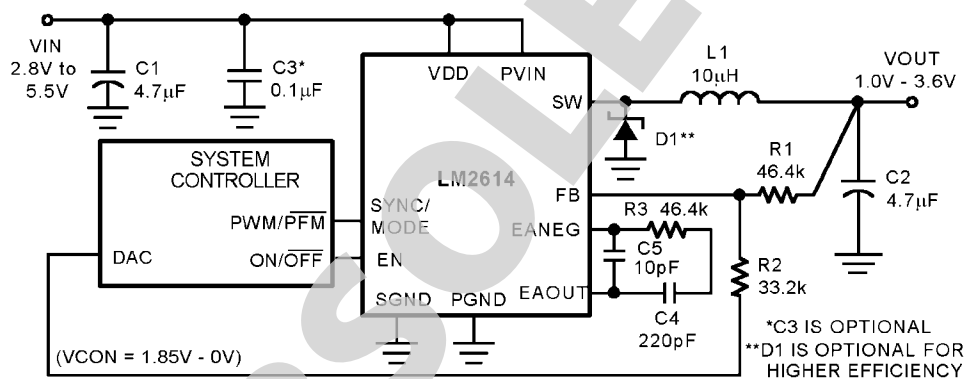

20036706

FIGURE 4. Typical Operating Circuit

CIRCUIT OPERATION

Referring to [Figure 4](#), [Figure 5](#), [Figure 6](#) and [Figure 7](#), the LM2614 operates as follows. During the first part of each switching cycle, the control block in the LM2614 turns on the internal PFET switch. This allows current to flow from the input through the inductor to the output filter capacitor and load. The inductor limits the current to a ramp with a slope of $(V_{IN} - V_{OUT})/L$, by storing energy in a magnetic field. During the second part of each cycle, the controller turns the PFET switch off, blocking current flow from the input, and then turns the NFET synchronous rectifier on. In response, the inductor's magnetic field collapses, generating a voltage that forces current from ground through the synchronous rectifier to the output filter capacitor and load. As the stored energy is trans-

ferred back into the circuit and depleted, the inductor current ramps down with a slope of V_{OUT}/L . If the inductor current reaches zero before the next cycle, the synchronous rectifier is turned off to prevent current reversal. The output filter capacitor stores charge when the inductor current is high, and releases it when low, smoothing the voltage across the load.

The output voltage is regulated by modulating the PFET switch on time to control the average current sent to the load. The effect is identical to sending a duty-cycle modulated rectangular wave formed by the switch and synchronous rectifier at SW to a low-pass filter formed by the inductor and output filter capacitor. The output voltage is equal to the average voltage at the SW pin.

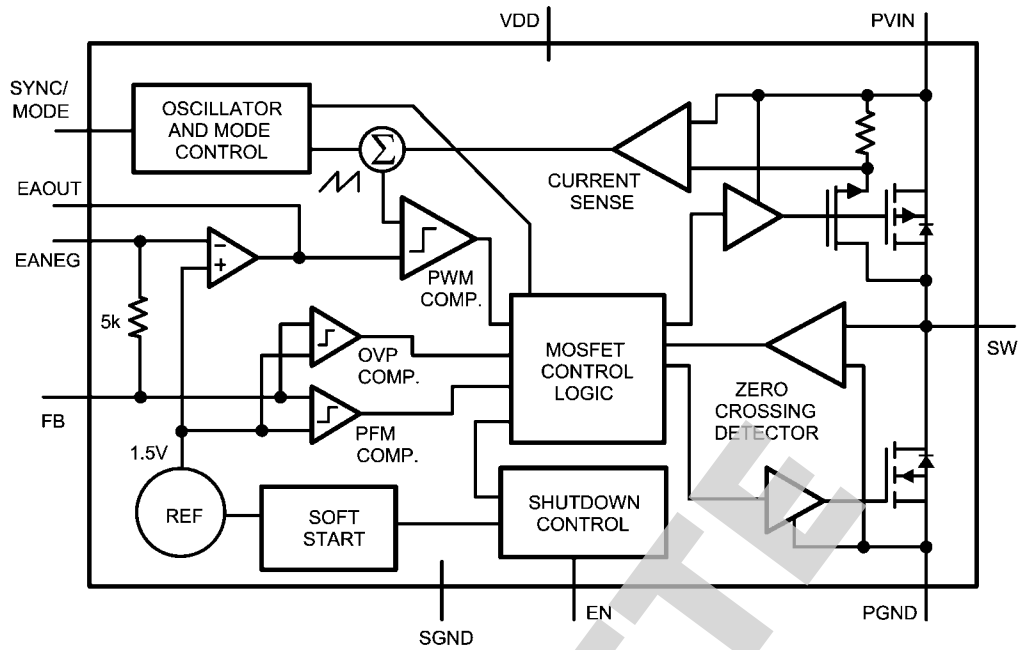

20036707

FIGURE 5. Simplified Functional Diagram

PWM OPERATION

While in PWM (Pulse Width Modulation) mode, the output voltage is regulated by switching at a constant frequency and then modulating the energy per cycle to control power to the load. Energy per cycle is set by modulating the PFET switch on-time pulse-width to control the peak inductor current. This is done by comparing the signal from the current-sense amplifier with a slope compensated error signal from the voltage-feedback error amplifier. At the beginning of each cycle, the clock turns on the PFET switch, causing the inductor current to ramp up. When the current sense signal ramps past the error amplifier signal, the PWM comparator turns off the PFET switch and turns on the NFET synchronous rectifier, ending the first part of the cycle. If an increase in load pulls the output voltage down, the error amplifier output increases, which allows the inductor current to ramp higher before the comparator turns off the PFET. This increases the average current sent to the output and adjusts for the increase in the load.

Before going to the PWM comparator, the error signal is summed with a slope compensation ramp from the oscillator for stability of the current feedback loop. During the second part of the cycle, a zero crossing detector turns off the NFET synchronous rectifier if the inductor current ramps to zero. The minimum on time of the PFET in PWM mode is about 200ns.

PWM Mode Switching Waveform

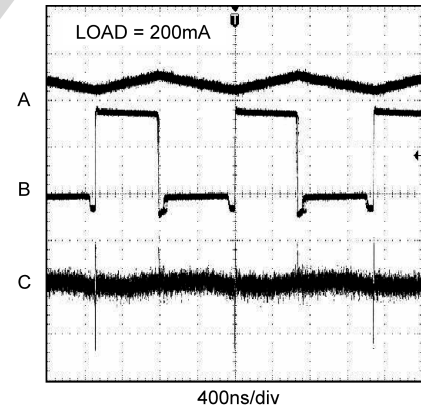

20036725

- A: Inductor Current, 500mA/div
- B: SW Pin, 2V/div
- C: V_{OUT} , 10mV/div, AC Coupled

FIGURE 6.

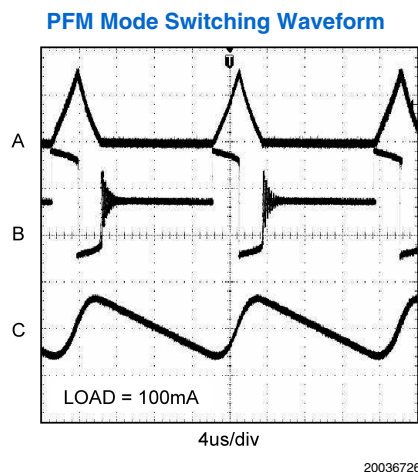

A: Inductor Current, 500mA/div
 B: SW Pin, 2V/div
 C: V_{OUT} , 50mV/div, AC Coupled

FIGURE 7.

PFM OPERATION

Connecting the SYNC/MODE to SGND sets the LM2614 to hysteretic PFM operation. While in PFM (Pulse Frequency Modulation) mode, the output voltage is regulated by switching with a discrete energy per cycle and then modulating the cycle rate, or frequency, to control power to the load. This is done by using an error comparator to sense the output voltage. The device waits as the load discharges the output filter capacitor, until the output voltage drops below the lower threshold of the PFM error-comparator. Then the device initiates a cycle by turning on the PFET switch. This allows current to flow from the input, through the inductor to the output, charging the output filter capacitor. The PFET is turned off when the output voltage rises above the regulation threshold of the PFM error comparator. Thus, the output voltage ripple in PFM mode is proportional to the hysteresis of the error comparator.

In PFM mode, the device only switches as needed to service the load. This lowers current consumption by reducing power consumed during the switching action in the circuit, due to transition losses in the internal MOSFETs, gate drive currents, eddy current losses in the inductor, etc. It also improves light-load voltage regulation. During the second half of the cycle, the intrinsic body diode of the NFET synchronous rectifier conducts until the inductor current ramps to zero.

OPERATING MODE SELECTION

The LM2614 is designed for digital control of the operating modes by the system controller. This prevents the spurious switch over from low-noise PWM mode between transmission intervals in mobile phone applications that can occur in other products.

The SYNC/MODE digital input pin is used to select the operating mode. Setting SYNC/MODE high (above 1.3V) selects 600kHz current-mode PWM operation. PWM mode is optimized for low-noise, high-power operation for use when the load is active. Setting SYNC/MODE low (below 0.4V) selects hysteretic voltage-mode PFM operation. PFM mode is optimized for reducing power consumption and extending battery life when the load is in a low-power standby mode. In PFM mode, quiescent current into the V_{DD} pin is 160 μ A typ. In contrast, PWM mode V_{DD} -pin quiescent current is 600 μ A typ.

PWM operation is intended for use with loads of 50mA or more, when low noise operation is desired. Below 100mA, PFM operation can be used to allow precise regulation, and reduced current consumption. However, it should be noted that for PA applications the PFM mode need not be used as output voltage slew rates are of more concern to the system designer. The LM2614 has an over-voltage feature that prevents the output voltage from rising too high, when the device is left in PWM mode under low-load conditions. See *Over-voltage Protection*, for more information.

Switch modes with the SYNC/MODE pin, using a signal with a slew rate faster than 5V/100 μ s. Use a comparator, Schmitt trigger or logic gate to drive the SYNC/MODE pin. Do not leave the pin floating or allow it to linger between thresholds. These measures will prevent output voltage errors in response to an indeterminate logic state. The LM2614 switches on each rising edge of SYNC. Ensure a minimum load to keep the output voltage in regulation when switching modes frequently.

FREQUENCY SYNCHRONIZATION

The SYNC/MODE input can also be used for frequency synchronization. During synchronization, the LM2614 initiates cycles on the rising edge of the clock. When synchronized to an external clock, it operates in PWM mode. The device can synchronize to a 50% duty-cycle clock over frequencies from 500kHz to 1MHz. If a different duty cycle is used other than 50% the range for acceptable duty cycles are 30% to 70%.

Use the following waveform and duty cycle guidelines when applying an external clock to the SYNC/MODE pin. Clock under/overshoot should be less than 100mV below GND or above V_{DD} . When applying noisy clock signals, especially sharp edged signals from a long cable during evaluation, terminate the cable at its characteristic impedance and add an RC filter to the SYNC pin, if necessary, to soften the slew rate and over/undershoot. Note that sharp edged signals from a pulse or function generator can develop under/overshoot as high as 10V at the end of an improperly terminated cable.

OVERVOLTAGE PROTECTION

The LM2614 has an over-voltage comparator that prevents the output voltage from rising too high when the device is left in PWM mode under low-load conditions. When the output voltage rises by about 100mV (Figure 3) over its regulation threshold, the OVP comparator inhibits PWM operation to skip pulses until the output voltage returns to the regulation threshold. When resistor dividers are used the OVP threshold at the output will be the value of the threshold at the feedback pin times the resistor divider ratio. In over voltage protection, output voltage and ripple will increase.

SHUTDOWN MODE

Setting the EN digital input pin low (<0.4V) places the LM2614 in a 0.02 μ A (typ) shutdown mode. During shutdown, the PFET switch, NFET synchronous rectifier, reference, control and bias circuitry of the LM2614 are turned off. Setting EN high enables normal operation. While turning on, soft start is activated.

EN should be set low to turn off the LM2614 during system power-up and undervoltage conditions when the supply is less than the 2.8V minimum operating voltage. The LM2614 is designed for compact portable applications, such as mobile phones. In such applications, the system controller determines power supply sequencing. Although the LM2614 is typically well behaved at low input voltages, this is not guaranteed.

INTERNAL SYNCHRONOUS RECTIFICATION

While in PWM mode, the LM2614 uses an internal NFET as a synchronous rectifier to reduce rectifier forward voltage drop and associated power loss. Synchronous rectification provides a significant improvement in efficiency whenever the output voltage is relatively low compared to the voltage drop across an ordinary rectifier diode.

The internal NFET synchronous rectifier is turned on during the inductor current down slope during the second part of each cycle. The synchronous rectifier is turned off prior to the next cycle, or when the inductor current ramps to zero at light loads. The NFET is designed to conduct through its intrinsic body diode during transient intervals before it turns on, eliminating the need for an external diode.

CURRENT LIMITING

A current limit feature allows the LM2614 to protect itself and external components during overload conditions. In PWM mode cycle-by-cycle current limit is normally used. If an excessive load pulls the voltage at the feedback pin down to approximately 0.7V, then the device switches to a timed current limit mode. In timed current limit mode the internal P-FET switch is turned off after the current comparator trips and the beginning of the next cycle is inhibited for 2.5µs to force the instantaneous inductor current to ramp down to a safe value. Timed current limit mode prevents the loss of current control seen in some products when the voltage at the feedback pin is pulled low in serious overload conditions.

DYNAMICALLY ADJUSTABLE OUTPUT VOLTAGE

The LM2614 can be used to provide dynamically adjustable output voltage by using external feedback resistors. The output can be varied from 1.0V to 3.6V in less than 30µs by using an analog control signal (VCON) at the external feedback resistors. This feature is useful in PA applications where peak power is needed only when the handset is far away from the base station or when data is being transmitted. In other instances the transmitting power can be reduced and hence the supply voltage to the PA can be reduced helping maintain longer battery life. See *Setting the Output Voltage in the Application Information* section for further details.

In dropout conditions the output voltage is $V_{IN} - I_{OUT}(R_{dc} + R_{DSON(P)})$ where R_{dc} is the series resistance of the inductor and $R_{DSON(P)}$ is the on resistance of the PFET.

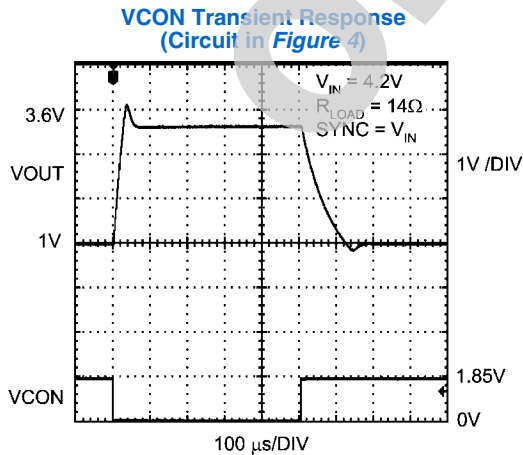
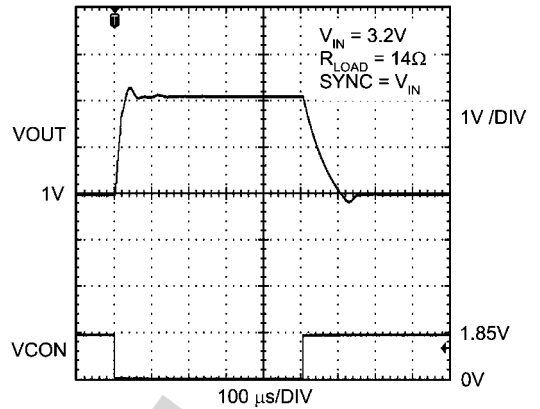

FIGURE 8.

20036719

VCON Transient Response in Dropout (Circuit in Figure 4)



20036720

FIGURE 9.

Load Transient Response (Circuit in Figure 3)

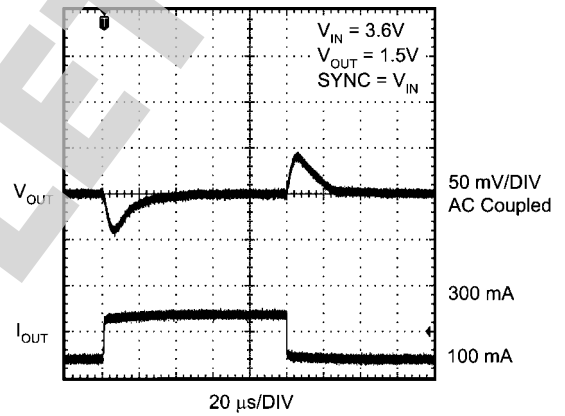

20036727

FIGURE 10.

Line Transient Response (Circuit in Figure 3)

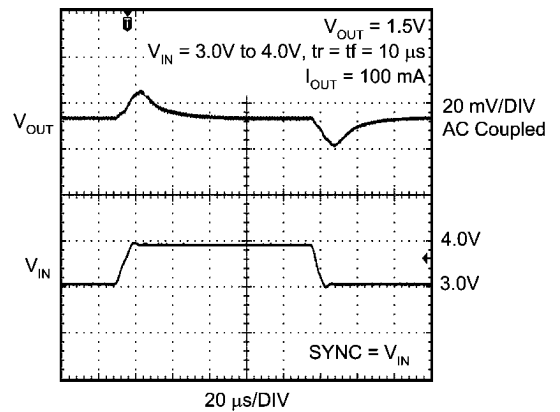

20036728

FIGURE 11.

SOFT-START

The LM2614 has soft start to reduce current inrush during power-up and startup. This reduces stress on the LM2614 and external components. It also reduces startup transients on the power source. Soft start is implemented by ramping up the reference input to the error amplifier of the LM2614 to gradually increase the output voltage.

THERMAL SHUTDOWN PROTECTION

The LM2614 has a thermal shutdown protection function to protect itself from short-term misuse and overload conditions. When the junction temperature exceeds 150°C the device turns off the output stage and when the temperature drops below 130°C it initiates a soft start cycle. Prolonged operation in thermal shutdown conditions may damage the device and is considered bad practice.

Application Information

SETTING THE OUTPUT VOLTAGE

The LM2614 can be used with external feedback resistors and an analog signal to vary the output voltage. Select an output voltage from 1.0V to 3.6V by setting the voltage on the VCON as directed in [Table 1](#).

TABLE 1. Output Voltage Selection

VCON (V)	VOOUT (V)
VCON = 0V	$V_{FB} (1+R1/R2)$
VCON > 0V	$V_{FB} (1+R1/R2) - VCON (R1/R2)$

Refer to [Figure 12](#) for the relation between VOOUT and VCON.

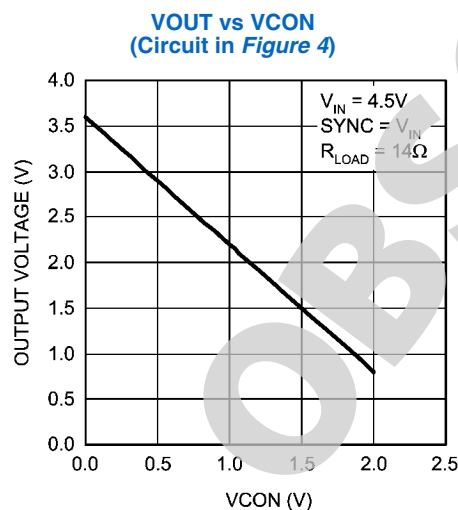

FIGURE 12.

TABLE 2. Suggested Inductors and Their Suppliers

Part Number	Vendor	Phone	FAX
DO1608C-103	Coilcraft	847-639-6400	847-639-1469
P1174.103T	Pulse	858-674-8100	858-674-8262
ELL6RH100M	Panasonic	714-373-7366	714-373-7323
CDRH5D18-100	Sumida	847-956-0666	847-956-0702
P0770.103T	Pulse	858-674-8100	858-674-8262

When the control voltage is between 1.85V and 0V, the output voltage will vary in a monotonic fashion with respect to the voltage on the control pin as per the equation in [Table 1](#). Select the value of R2 to allow at least 100 times the feedback pin bias current to flow through it.

EXTERNAL COMPENSATION

The LM2614 uses external components connected to the EANEG and EAOUT pins to compensate the regulator ([Figure 4](#)). Typically, all that is required is a series connection of one capacitor (C4) and one resistor (R3). A capacitor (C5) can be connected across the EANEG and EAOUT pins to improve the noise immunity of the loop. C5 reacts with R3 to give a high frequency pole. C4 reacts with the high open loop gain of the error amplifier and the resistance at the EANEG pin to create the dominant pole for the system, while R3 and C4 react to create a zero in the frequency response. The pole rolls off the loop gain, to give a bandwidth somewhere between 10kHz and 50kHz, this avoids a 100kHz parasitic pole contributed by the current mode controller. Typical values in the 220pF to 1nF (C4) range are recommended to create a pole on the order of 10Hz or less.

The next dominant pole in the system is formed by the output capacitance (C2) and the parallel combination of the load resistance and the effective output resistance of the regulator. This combined resistance (Ro) is dominated by the small signal output resistance, which is typically in the range of 3Ω to 15Ω. The exact value of this resistance, and therefore this load pole depends on the steady state duty cycle and the internal ramp value. Ideally we want the zero formed by R3 and C4 to cancel this load pole, such that $R3 = RoC2/C4$. Due to the large variation in Ro, this ideal case can only be achieved at one operating condition. Therefore a compromise of about 5Ω for Ro should be used to determine a starting value for R3. This value can then be optimized on the bench to give the best transient response to load changes and changes in VCON, under all conditions. Typical values are 10pF for C5 and 220pF to 470pF for C4, to ensure good response from dropout conditions to $V_{OUT(min)}$.

INDUCTOR SELECTION

Use a 10μH inductor with saturation current rating higher than the peak current rating of the device. The inductor's resistance should be less than 0.3Ω for good efficiency. [Table 2](#) lists suggested inductors and suppliers.

For low-cost applications, an unshielded inductor is suggested. For noise critical applications, a toroidal or shielded inductor should be used. A good practice is to lay out the board with footprints accommodating both types for design flexibility. This allows substitution of a low-noise shielded inductor, in the event that noise from low-cost unshielded models is unacceptable.

The saturation current rating is the current level beyond which an inductor loses its inductance. Different manufacturers specify the saturation current rating differently. Some specify saturation current point to be when inductor value falls 30% from its original value, others specify 10%. It is always better to look at the inductance versus current curve and make sure the inductor value doesn't fall below 30% at the peak current rating of the LM2614. Beyond this rating, the inductor loses its ability to limit current through the PWM switch to a ramp. This can cause poor efficiency, regulation errors or stress to DC-DC converters like the LM2614. Saturation occurs when the magnetic flux density from current through the windings of the inductor exceeds what the inductor's core material can support with a corresponding magnetic field.

CAPACITOR SELECTION

Use a 4.7 μ F or 10 μ F ceramic input capacitor. A 10 μ F ceramic input capacitor is recommended if the PA represents a load <14 Ω . Use a 4.7 μ F ceramic output capacitor for getting faster slew rates for output voltages from V_{OUT} (min) to V_{OUT} (max). Use X7R or X5R types, do not use Y5V. The rise

time for the voltage from V_{OUT} (min) to V_{OUT} (max) depends on the slew rate of the error amp, switch peak current limit and the value of the output capacitor. The time for the output to change from V_{OUT} (max) to V_{OUT} (min) depends on R_{LOAD} and C_{OUT} . Use of tantalum capacitors is not recommended.

Ceramic capacitors provide an optimal balance between small size, cost, reliability and performance for cell phones and similar applications. A 22 μ F ceramic output capacitor can be used in applications requiring fixed output voltages and/or increased tolerance to heavy load transients. A 10 μ F ceramic output capacitor can be used in applications where the worst case load transient step is less than 200mA. [Table 3](#) lists suggested capacitors and suppliers.

The input filter capacitor supplies current to the PFET switch of the LM2614 in the first part of each cycle and reduces voltage ripple imposed on the input power source. The output filter capacitor smoothes out current flow from the inductor to the load, helps maintain a steady output voltage during transient load changes and reduces output voltage ripple. These capacitors must be selected with sufficient capacitance and sufficiently low ESR to perform these functions. Parallel combinations of smaller value ceramic capacitors can also be used on the output as long as the combined value is at least 4.7 μ F for the application circuit in [Figure 1](#).

The ESR, or equivalent series resistance, of the filter capacitors is a major factor in voltage ripple.

TABLE 3. Suggested Capacitors and Their Suppliers

Model	Type	Vendor	Phone	FAX
C1, C2 (Input or Output Filter Capacitor)				
JMK212BJ475MG	Ceramic	Taiyo-Yuden	847-925-0888	847-925-0899
LMK316BJ475ML	Ceramic	Taiyo-Yuden	847-925-0888	847-925-0899
C2012X5R0J475K	Ceramic	TDK	847-803-6100	847-803-6296
JMK325BJ226MM	Ceramic	Taiyo-Yuden	847-925-0888	847-925-0899
JMK212BJ106MG	Ceramic	Taiyo-Yuden	847-925-0888	847-925-0899

micro SMD PACKAGE ASSEMBLY AND USE

Use of the micro SMD package requires specialized board layout, precision mounting and careful reflow techniques, as detailed in National Semiconductor Application Note AN-1112. Refer to the section *Surface Mount Technology (SMT) Assembly Considerations*. For best results in assembly, alignment ordinals on the PC board should be used to facilitate placement of the device.

The pad style used with micro SMD package must be the NSMD (non-solder mask defined) type. This means that the solder-mask opening is larger than the pad size. This prevents a lip that otherwise forms if the solder-mask and pad overlap, from holding the device off the surface of the board and interfering with mounting. See Application Note AN-1112 for specific instructions how to do this.

The 10-Bump package used for the LM2614 has 300 micron solder balls and requires 10.82mil pads for mounting on the circuit board. The trace to each pad should enter the pad with a 90° entry angle to prevent debris from being caught in deep corners. Initially, the trace to each pad should be 6–7mil wide, for a section approximately 6mil long, as a thermal relief. Then each trace should neck up or down to its optimal width. The important criterion is symmetry. This ensures the solder bumps on the LM2614 reflow evenly and that the device solders level to the board. In particular, special attention must be paid to the pads for bumps D3–B3. Because PGND and PVIN

are typically connected to large copper planes, inadequate thermal reliefs can result in late or inadequate reflow of these bumps.

The micro SMD package is optimized for the smallest possible size in applications with red or infrared opaque cases. Because the micro SMD package lacks the plastic encapsulation characteristic of larger devices, it is vulnerable to light. Backside metalization and/or epoxy coating, along with front-side shading by the printed circuit board, reduce this sensitivity.

BOARD LAYOUT CONSIDERATIONS

PC board layout is an important part of DC-DC converter design. Poor board layout can disrupt the performance of a DC-DC converter and surrounding circuitry by contributing to EMI, ground bounce, and resistive voltage loss in the traces. These can send erroneous signals to the DC-DC converter IC, resulting in poor regulation or instability. Poor layout can also result in reflow problems leading to poor solder joints between the micro SMD package and board pads. Poor solder joints can result in erratic or degraded performance.

Good layout for the LM2614 can be implemented by following a few simple design rules.

1. Place the LM2614 on 10.82 mil (10.82/1000 in.) pads. As a thermal relief, connect to each pad with a 7 mil wide, approximately 7 mil long traces, and then incrementally

increase each trace to its optimal width. The important criterion is symmetry to ensure the solder bumps on the LM2614 reflow evenly (see *micro SMD Package Assembly and Use*).

2. *Place the LM2614, inductor and filter capacitors close together and make the traces short.* The traces between these components carry relatively high switching currents and act as antennas. Following this rule reduces radiated noise. Place the capacitors and inductor within 0.2 in. (5 mm) of the LM2614.
3. *Arrange the components so that the switching current loops curl in the same direction.* During the first half of each cycle, current flows from the input filter capacitor, through the LM2614 and inductor to the output filter capacitor and back through ground, forming a current loop. In the second half of each cycle, current is pulled up from ground, through the LM2614 by the inductor, to the output filter capacitor and then back through ground, forming a second current loop. Routing these loops so the current curls in the same direction prevents magnetic field reversal between the two half-cycles and reduces radiated noise.
4. *Connect the ground pins of the LM2614, and filter capacitors together using generous component-side copper fill as a pseudo-ground plane. Then, connect this to the ground-plane (if one is used) with several vias.* This reduces ground-plane noise by preventing the switching currents from circulating through the ground plane. It also

reduces ground bounce at the LM2614 by giving it a low-impedance ground connection.

5. *Use wide traces between the power components and for power connections to the DC-DC converter circuit.* This reduces voltage errors caused by resistive losses across the traces.
6. *Route noise sensitive traces, such as the voltage feedback path, away from noisy traces between the power components.* The voltage feedback trace must remain close to the LM2614 circuit and should be routed directly from V_{OUT} at the output capacitor and should be routed opposite to noise components. This reduces EMI radiated onto the DC-DC converter's own voltage feedback trace.
7. *Place noise sensitive circuitry, such as radio IF blocks, away from the DC-DC converter, CMOS digital blocks and other noisy circuitry.* Interference with noise-sensitive circuitry in the system can be reduced through distance.

In mobile phones, for example, a common practice is to place the DC-DC converter on one corner of the board, arrange the CMOS digital circuitry around it (since this also generates noise), and then place sensitive preamplifiers and IF stages on the diagonally opposing corner. Often, the sensitive circuitry is shielded with a metal pan and power to it is post-regulated to reduce conducted noise, using low-dropout linear regulators.

OBSOLETE

Physical Dimensions inches (millimeters) unless otherwise noted

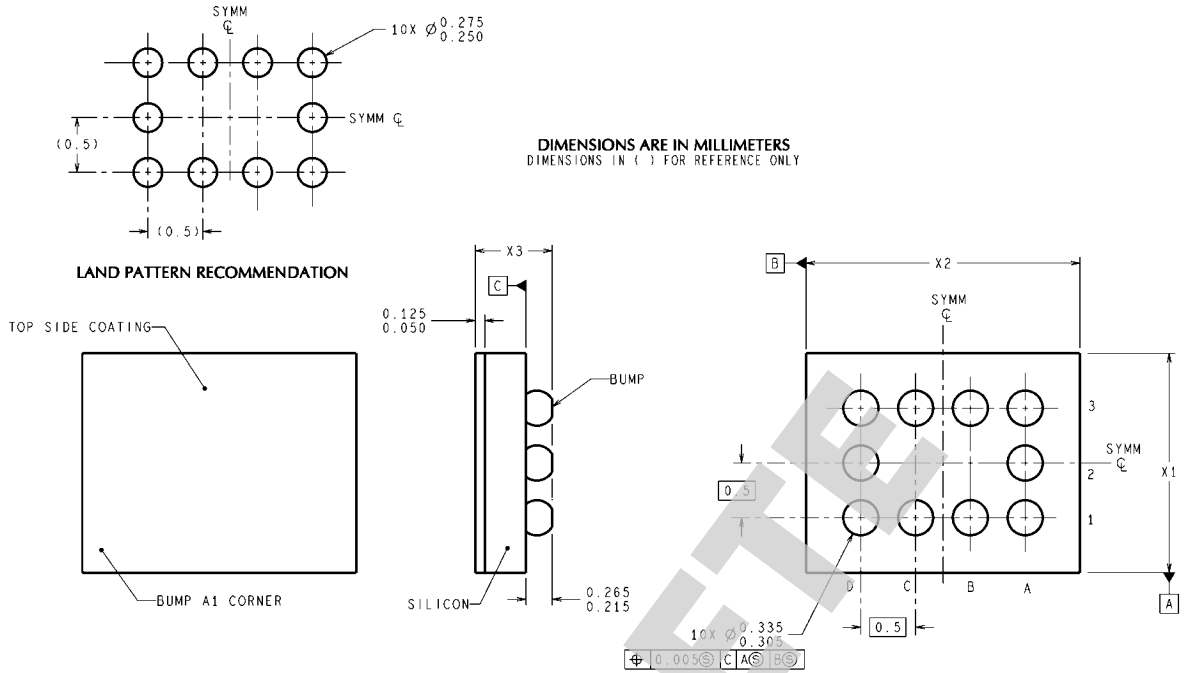

NOTES: UNLESS OTHERWISE SPECIFIED

1. EPOXY COATING
2. 63Sn/37Pb EUTECTIC BUMP
3. RECOMMEND NON-SOLDER MASK DEFINED LANDING PAD.
4. PIN A1 IS ESTABLISHED BY LOWER LEFT CORNER WITH RESPECT TO TEXT ORIENTATION.
5. XXX IN DRAWING NUMBER REPRESENTS PACKAGE SIZE VARIATION WHERE X1 IS PACKAGE WIDTH, X2 IS PACKAGE LENGTH AND X3 IS PACKAGE HEIGHT.
6. REFERENCE JEDEC REGISTRATION MO-211. VARIATION BD.

10-Bump micro SMD Package
NS Package Number TLP106WA
The dimensions for X1, X2 and X3 are as given:
X1 = 2.250 ±0.030 mm
X2 = 2.504 ±0.030 mm
X3 = 0.600 ±0.075 mm

Notes

LM2614

OBSOLETE

Notes

For more National Semiconductor product information and proven design tools, visit the following Web sites at:
www.national.com

Products		Design Support	
Amplifiers	www.national.com/amplifiers	WEBENCH® Tools	www.national.com/webench
Audio	www.national.com/audio	App Notes	www.national.com/appnotes
Clock and Timing	www.national.com/timing	Reference Designs	www.national.com/refdesigns
Data Converters	www.national.com/adc	Samples	www.national.com/samples
Interface	www.national.com/interface	Eval Boards	www.national.com/evalboards
LVDS	www.national.com/lvds	Packaging	www.national.com/packaging
Power Management	www.national.com/power	Green Compliance	www.national.com/quality/green
Switching Regulators	www.national.com/switchers	Distributors	www.national.com/contacts
LDOs	www.national.com/ldo	Quality and Reliability	www.national.com/quality
LED Lighting	www.national.com/led	Feedback/Support	www.national.com/feedback
Voltage References	www.national.com/vref	Design Made Easy	www.national.com/easy
PowerWise® Solutions	www.national.com/powerwise	Applications & Markets	www.national.com/solutions
Serial Digital Interface (SDI)	www.national.com/sdi	Mil/Aero	www.national.com/milaero
Temperature Sensors	www.national.com/tempensors	SolarMagic™	www.national.com/solarmagic
PLL/VCO	www.national.com/wireless	PowerWise® Design University	www.national.com/training

THE CONTENTS OF THIS DOCUMENT ARE PROVIDED IN CONNECTION WITH NATIONAL SEMICONDUCTOR CORPORATION ("NATIONAL") PRODUCTS. NATIONAL MAKES NO REPRESENTATIONS OR WARRANTIES WITH RESPECT TO THE ACCURACY OR COMPLETENESS OF THE CONTENTS OF THIS PUBLICATION AND RESERVES THE RIGHT TO MAKE CHANGES TO SPECIFICATIONS AND PRODUCT DESCRIPTIONS AT ANY TIME WITHOUT NOTICE. NO LICENSE, WHETHER EXPRESS, IMPLIED, ARISING BY ESTOPPEL OR OTHERWISE, TO ANY INTELLECTUAL PROPERTY RIGHTS IS GRANTED BY THIS DOCUMENT.

TESTING AND OTHER QUALITY CONTROLS ARE USED TO THE EXTENT NATIONAL DEEMS NECESSARY TO SUPPORT NATIONAL'S PRODUCT WARRANTY. EXCEPT WHERE MANDATED BY GOVERNMENT REQUIREMENTS, TESTING OF ALL PARAMETERS OF EACH PRODUCT IS NOT NECESSARILY PERFORMED. NATIONAL ASSUMES NO LIABILITY FOR APPLICATIONS ASSISTANCE OR BUYER PRODUCT DESIGN. BUYERS ARE RESPONSIBLE FOR THEIR PRODUCTS AND APPLICATIONS USING NATIONAL COMPONENTS. PRIOR TO USING OR DISTRIBUTING ANY PRODUCTS THAT INCLUDE NATIONAL COMPONENTS, BUYERS SHOULD PROVIDE ADEQUATE DESIGN, TESTING AND OPERATING SAFEGUARDS.

EXCEPT AS PROVIDED IN NATIONAL'S TERMS AND CONDITIONS OF SALE FOR SUCH PRODUCTS, NATIONAL ASSUMES NO LIABILITY WHATSOEVER, AND NATIONAL DISCLAIMS ANY EXPRESS OR IMPLIED WARRANTY RELATING TO THE SALE AND/OR USE OF NATIONAL PRODUCTS INCLUDING LIABILITY OR WARRANTIES RELATING TO FITNESS FOR A PARTICULAR PURPOSE, MERCHANTABILITY, OR INFRINGEMENT OF ANY PATENT, COPYRIGHT OR OTHER INTELLECTUAL PROPERTY RIGHT.

LIFE SUPPORT POLICY

NATIONAL'S PRODUCTS ARE NOT AUTHORIZED FOR USE AS CRITICAL COMPONENTS IN LIFE SUPPORT DEVICES OR SYSTEMS WITHOUT THE EXPRESS PRIOR WRITTEN APPROVAL OF THE CHIEF EXECUTIVE OFFICER AND GENERAL COUNSEL OF NATIONAL SEMICONDUCTOR CORPORATION. As used herein:

Life support devices or systems are devices which (a) are intended for surgical implant into the body, or (b) support or sustain life and whose failure to perform when properly used in accordance with instructions for use provided in the labeling can be reasonably expected to result in a significant injury to the user. A critical component is any component in a life support device or system whose failure to perform can be reasonably expected to cause the failure of the life support device or system or to affect its safety or effectiveness.

National Semiconductor and the National Semiconductor logo are registered trademarks of National Semiconductor Corporation. All other brand or product names may be trademarks or registered trademarks of their respective holders.

Copyright© 2011 National Semiconductor Corporation

For the most current product information visit us at www.national.com

National Semiconductor
Americas Technical
Support Center
Email: support@nsc.com
Tel: 1-800-272-9959

National Semiconductor Europe
Technical Support Center
Email: europe.support@nsc.com

National Semiconductor Asia
Pacific Technical Support Center
Email: ap.support@nsc.com

National Semiconductor Japan
Technical Support Center
Email: jpn.feedback@nsc.com