

1200V XPT™ IGBT GenX4™

IXYN140N120A4

Ultra Low-V_{sat} IGBT for
up to 5kHz Switching

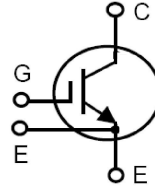

$$V_{CES} = 1200V$$

$$I_{C110} = 140A$$

$$V_{CE(sat)} \leq 1.70V$$

$$t_{fi(typ)} = 320ns$$

SOT-227B, miniBLOC

E153432

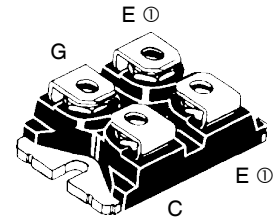

G = Gate, C = Collector, E = Emitter
Ⓢ either emitter terminal can be used as
Main or Kelvin Emitter

Symbol	Test Conditions	Maximum Ratings	
V_{CES}	$T_J = 25^\circ C$ to $175^\circ C$	1200	V
V_{CGR}	$T_J = 25^\circ C$ to $175^\circ C$, $R_{GE} = 1M\Omega$	1200	V
V_{GES}	Continuous	± 20	V
V_{GEM}	Transient	± 30	V
I_{C25}	$T_C = 25^\circ C$ (Chip Capability)	380	A
I_{LRMS}	Terminal Current Limit	200	A
I_{C110}	$T_C = 110^\circ C$	140	A
I_{CM}	$T_C = 25^\circ C$, 1ms	1200	A
SSOA (RBSOA)	$V_{GE} = 15V$, $T_{VJ} = 125^\circ C$, $R_G = 2\Omega$ Clamped Inductive Load	$I_{CM} = 280$ $0.8 \cdot V_{CES}$	A V
P_C	$T_C = 25^\circ C$	1070	W
T_J		-55 ... +175	$^\circ C$
T_{JM}		175	$^\circ C$
T_{stg}		-55 ... +175	$^\circ C$
V_{ISOL}	50/60Hz $I_{ISOL} \leq 1mA$	t = 1min t = 1s	2500 V~ 3000 V~
M_d	Mounting Torque Terminal Connection Torque	1.5/13 1.3/11.5	Nm/lb.in Nm/lb.in
Weight		30	g

Features

- miniBLOC, with Aluminium Nitride Isolation
- International Standard Package
- Isolation Voltage 2500V~
- Optimized for Low Conduction Losses
- Positive Thermal Coefficient of V_{ce(sat)}
- High Current Handling Capability

Advantages

- High Power Density
- Low Gate Drive Requirement

Applications

- Power Inverters
- UPS
- Motor Drives
- SMPS
- PFC Circuits
- Battery Chargers
- Welding Machines
- Lamp Ballasts
- Inrush Current Protection Circuits

Symbol	Test Conditions ($T_J = 25^\circ C$, Unless Otherwise Specified)	Characteristic Values		
		Min.	Typ.	Max.
BV_{CES}	$I_C = 250\mu A$, $V_{GE} = 0V$	1200		V
$V_{GE(th)}$	$I_C = 4mA$, $V_{CE} = V_{GE}$	4.5		6.5 V
I_{CES}	$V_{CE} = V_{CES}$, $V_{GE} = 0V$ $T_J = 125^\circ C$			25 μA 5 mA
I_{GES}	$V_{CE} = 0V$, $V_{GE} = \pm 20V$			± 200 nA
$V_{CE(sat)}$	$I_C = I_{C110}$, $V_{GE} = 15V$, Note 1 $T_J = 150^\circ C$		1.34 1.50	1.70 V V

Symbol Test Conditions ($T_J = 25^\circ\text{C}$ Unless Otherwise Specified)		Characteristic Values		
		Min.	Typ.	Max.
g_{fs}	$I_C = 60\text{A}, V_{CE} = 10\text{V}, \text{Note 1}$	60	100	S
C_{ies}	$V_{CE} = 25\text{V}, V_{GE} = 0\text{V}, f = 1\text{MHz}$		8300	pF
C_{oes}			470	pF
C_{res}			300	pF
$Q_{g(on)}$	$I_C = I_{C110}, V_{GE} = 15\text{V}, V_{CE} = 0.5 \cdot V_{CES}$		420	nC
Q_{ge}			68	nC
Q_{gc}			210	nC
$t_{d(on)}$	Inductive load, $T_J = 25^\circ\text{C}$ $I_C = 70\text{A}, V_{GE} = 15\text{V}$ $V_{CE} = 0.5 \cdot V_{CES}, R_G = 1.5\Omega$ Note 2		52	ns
t_{ri}			47	ns
E_{on}			4.9	mJ
$t_{d(off)}$			590	ns
t_{fi}			320	ns
E_{off}			12.0	mJ
$t_{d(on)}$	Inductive load, $T_J = 150^\circ\text{C}$ $I_C = 70\text{A}, V_{GE} = 15\text{V}$ $V_{CE} = 0.5 \cdot V_{CES}, R_G = 1.5\Omega$ Note 2		44	ns
t_{ri}			42	ns
E_{on}			7.4	mJ
$t_{d(off)}$			710	ns
t_{fi}			530	ns
E_{off}			20.0	mJ
R_{thJC}				0.14 °C/W
R_{thCS}		0.05		°C/W

Notes:

1. Pulse test, $t \leq 300\mu\text{s}$, duty cycle, $d \leq 2\%$.
2. Switching times & energy losses may increase for higher V_{CE} (clamp), T_J or R_G .

Littelfuse reserves the right to change limits, test conditions and dimensions.

IXYS MOSFETs and IGBTs are covered	4,835,592	4,931,844	5,049,961	5,237,481	6,162,665	6,404,065 B1	6,683,344	6,727,585	7,005,734 B2	7,157,338B2
by one or more of the following U.S. patents:	4,860,072	5,017,508	5,063,307	5,381,025	6,259,123 B1	6,534,343	6,710,405 B2	6,759,692	7,063,975 B2	
	4,881,106	5,034,796	5,187,117	5,486,715	6,306,728 B1	6,583,505	6,710,463	6,771,478 B2	7,071,537	

Fig. 1. Output Characteristics @ $T_J = 25^\circ\text{C}$

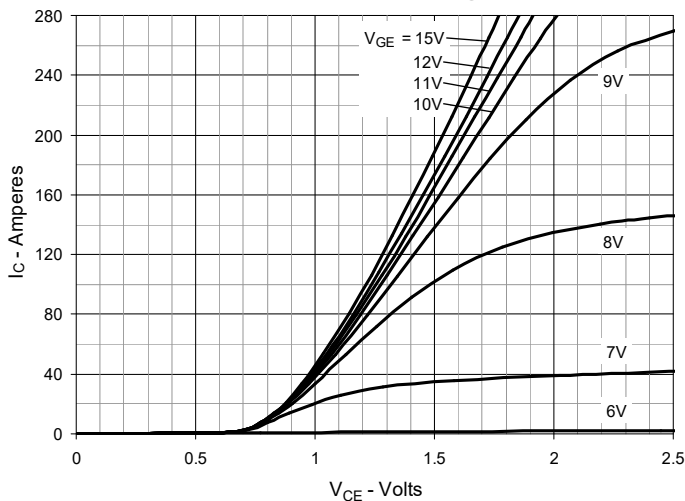

Fig. 2. Extended Output Characteristics @ $T_J = 25^\circ\text{C}$

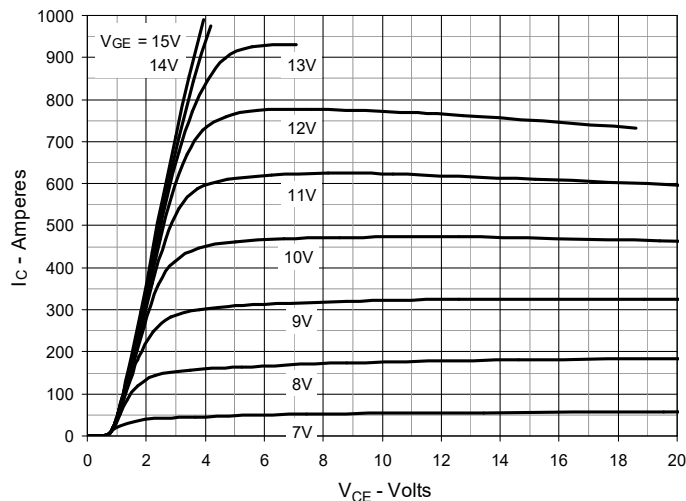

Fig. 3. Output Characteristics @ $T_J = 150^\circ\text{C}$

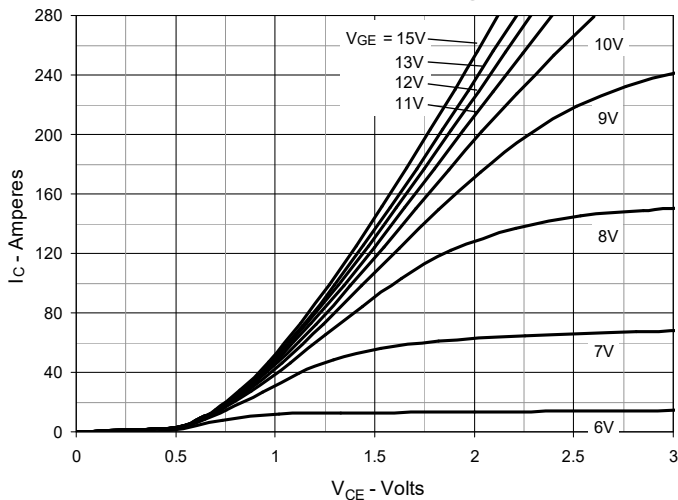

Fig. 4. Dependence of $V_{CE(sat)}$ on Junction Temperature

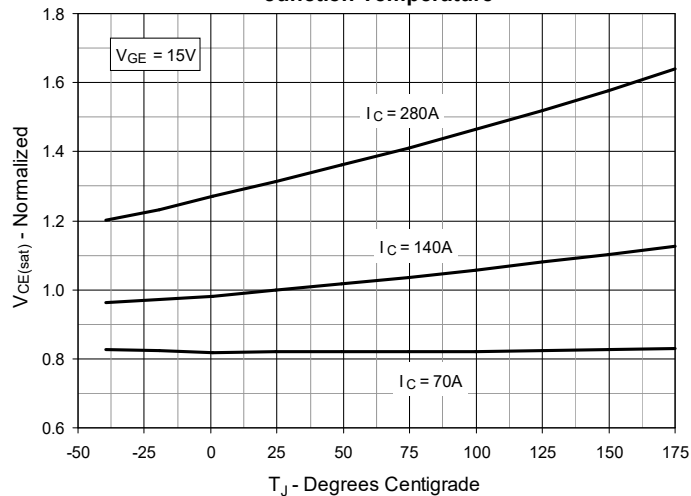

Fig. 5. Collector-to-Emitter Voltage vs. Gate-to-Emitter Voltage

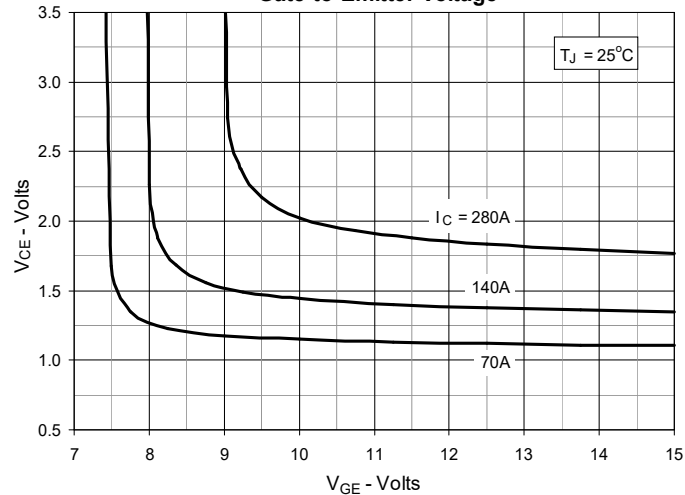

Fig. 6. Input Admittance

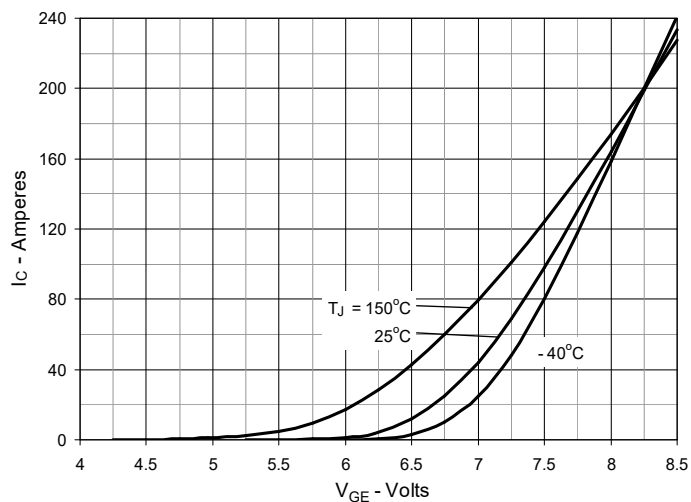

Fig. 7. Transconductance

Fig. 8. Gate Charge

Fig. 9. Capacitance

Fig. 10. Reverse-Bias Safe Operating Area

Fig. 11. Maximum Transient Thermal Impedance

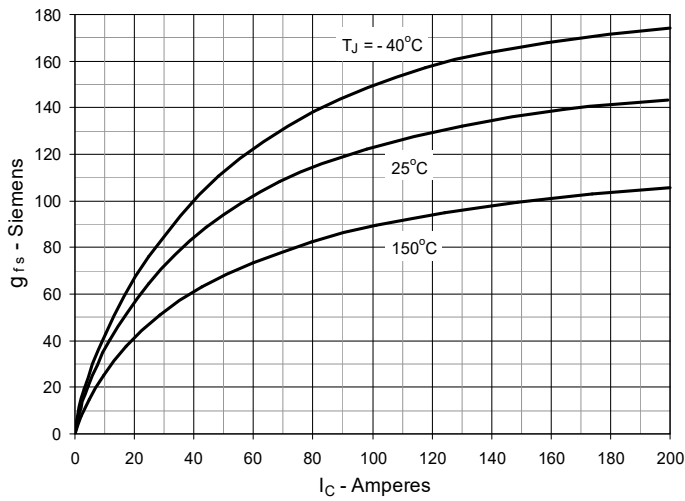
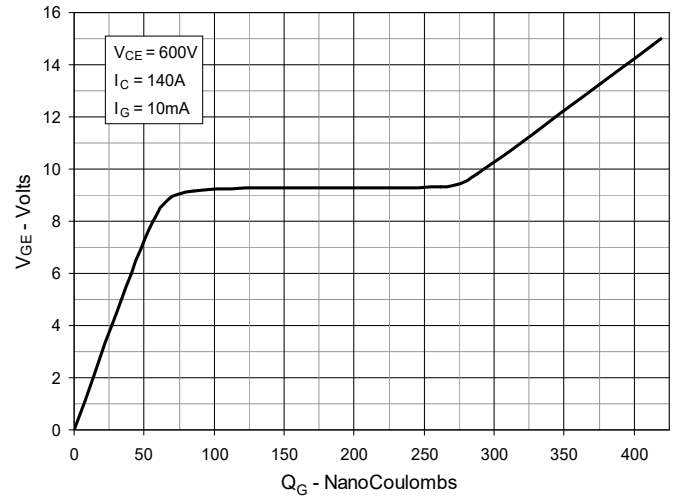
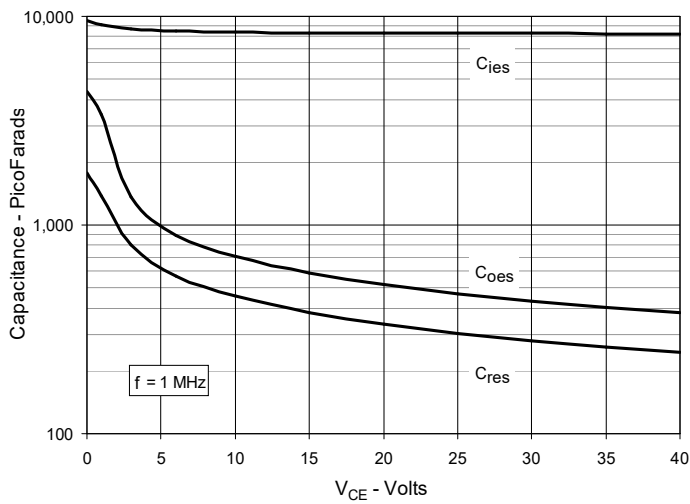
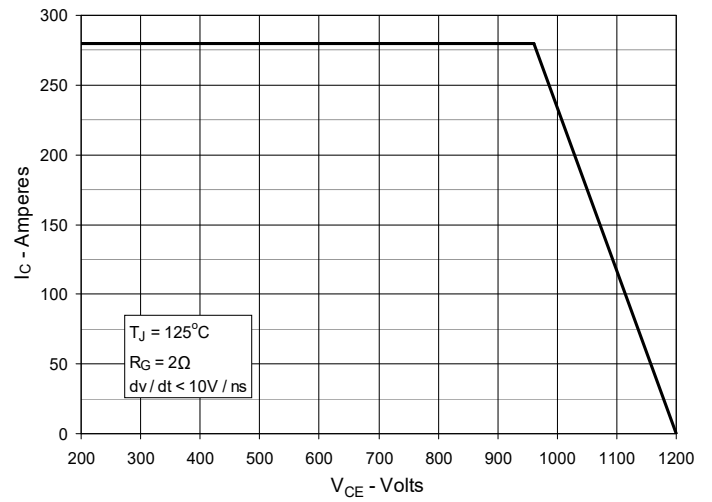
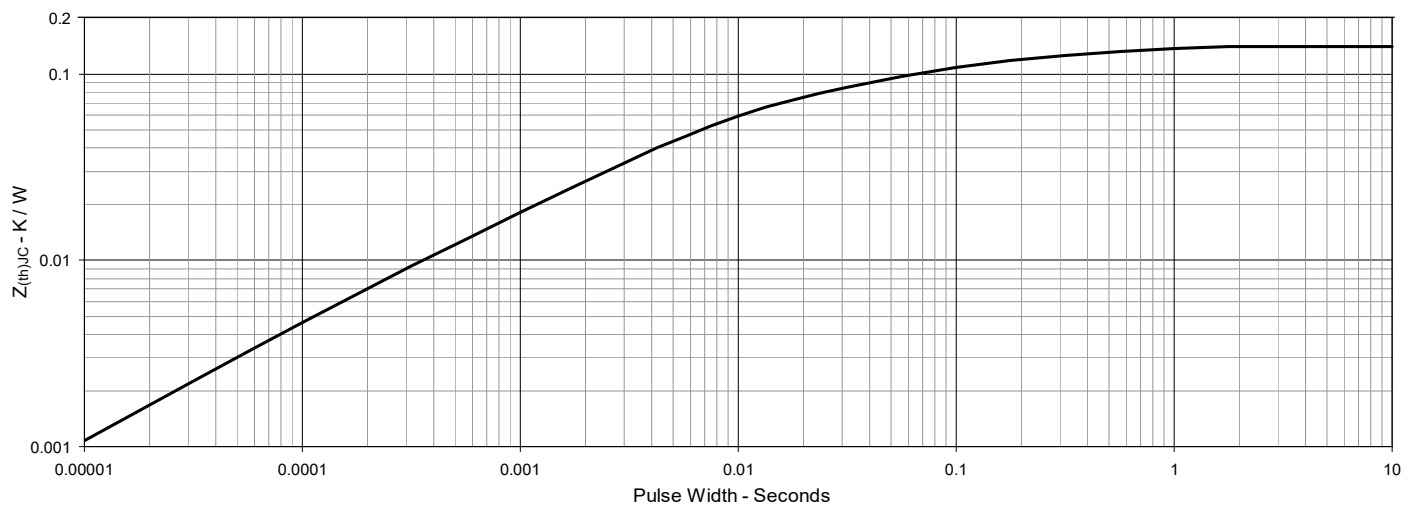
Fig. 12. Inductive Switching Energy Loss vs. Collector Current

Fig. 13. Inductive Switching Energy Loss vs. Collector-Emitter Voltage

Fig. 14. Inductive Switching Energy Loss vs. Gate Resistance

Fig. 15. Inductive Switching Energy Loss vs. Junction Temperature

Fig. 16. Inductive Turn-off Switching Times vs. Gate Resistance

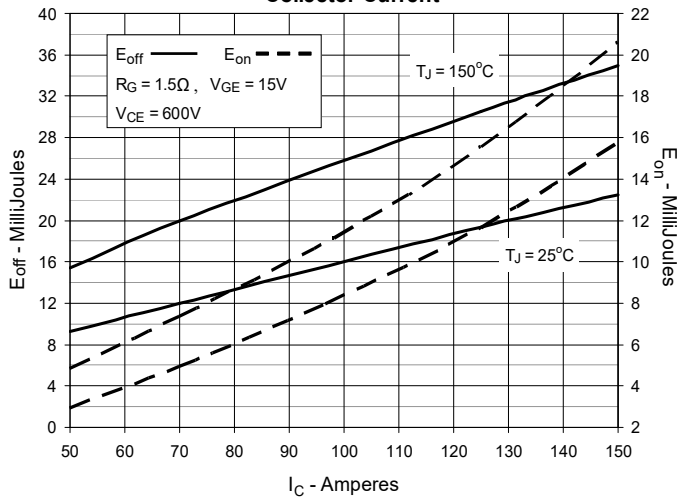
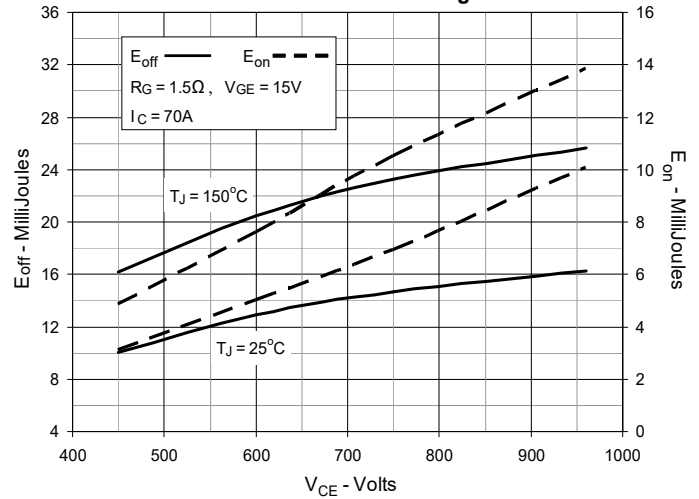
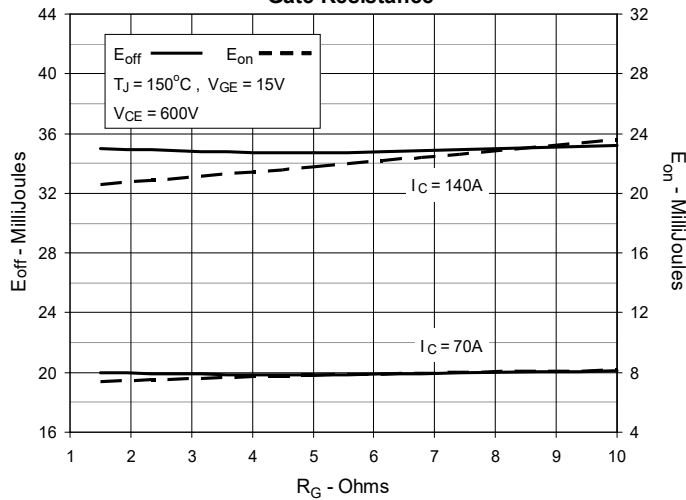
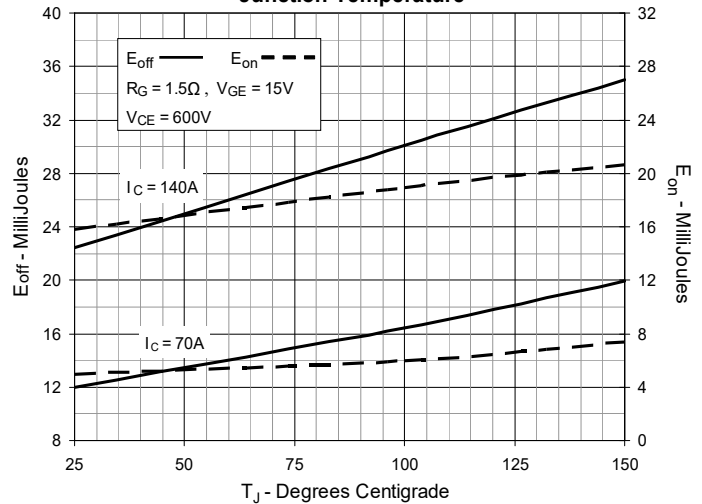
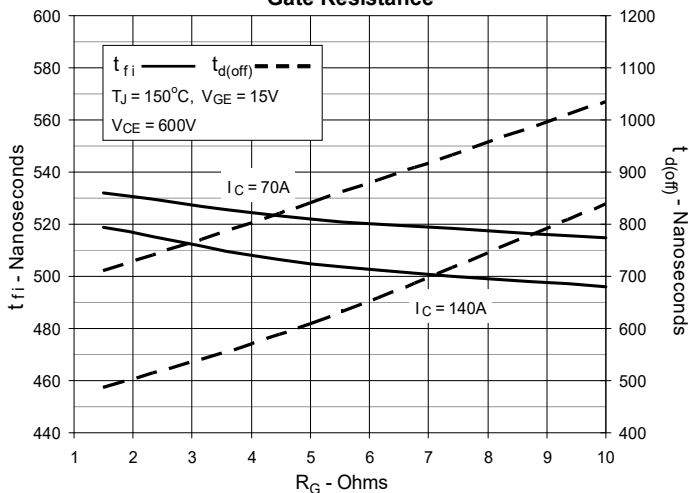
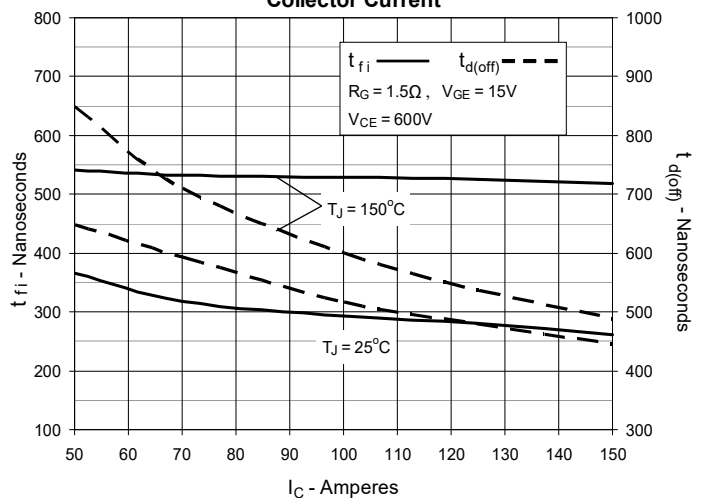
Fig. 17. Inductive Turn-off Switching Times vs. Collector Current

Fig. 18. Inductive Turn-off Switching Times vs. Junction Temperature

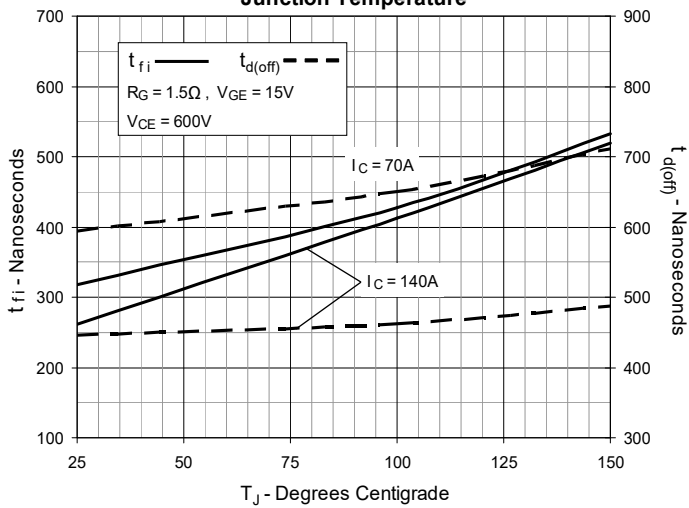

Fig. 19. Inductive Turn-on Switching Times vs. Gate Resistance

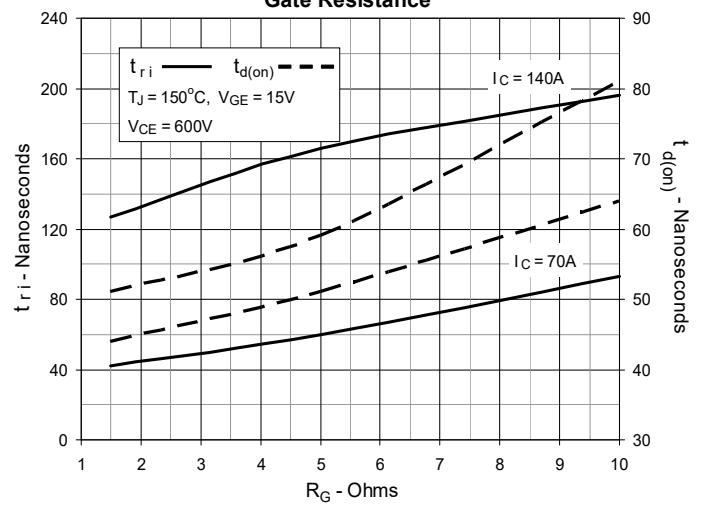

Fig. 20. Inductive Turn-on Switching Times vs. Collector Current

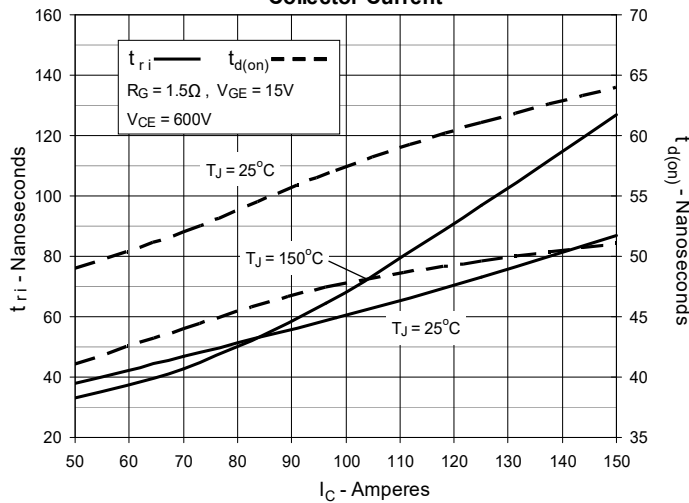
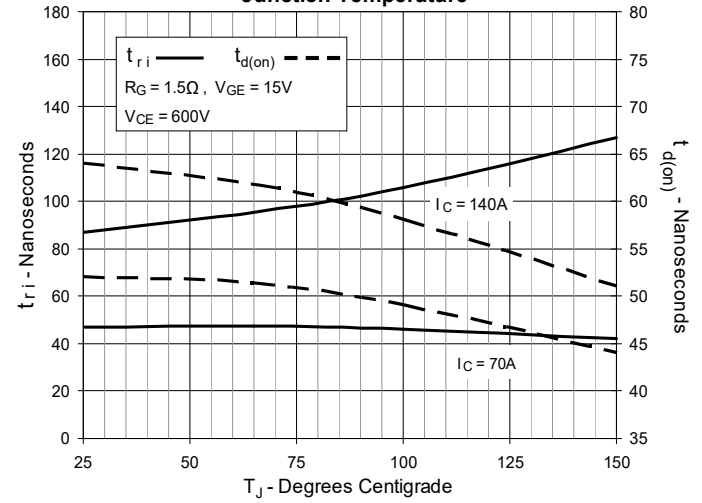
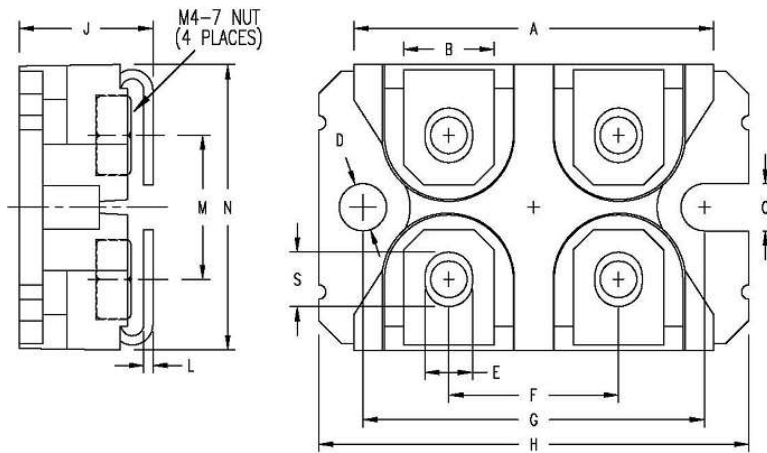
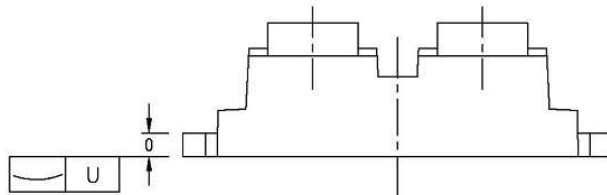

Fig. 21. Inductive Turn-on Switching Times vs. Junction Temperature



SOT-227B miniBLOC (IXYN)

SYM	INCHES		MILLIMETERS	
	MIN	MAX	MIN	MAX
A	1.224	1.260	31.10	32.00
B	.303	.327	7.70	8.30
C	.161	.173	4.10	4.40
D	.161	.173	4.10	4.40
E	.161	.173	4.10	4.40
F	.587	.598	14.90	15.20
G	1.181	1.201	30.00	30.50
H	1.488	1.508	37.80	38.30
J	.461	.484	11.70	12.30
L	.030	.033	0.75	0.85
M	.492	.512	12.50	13.00
N	.984	1.004	25.00	25.50
O	.075	.087	1.90	2.20
S	.181	.193	4.60	4.90
U	.000	.005	0.00	0.13



- NUT MATERIAL:
 STANDARD - Low carbon steel with Ni plating.
 OPTIONAL - Brass Nut is available.
 PART NUMBER-BN
- ALL METAL SURFACE ARE PRE NI PLATED EXCEPT TRIM AREA.



Disclaimer Notice - Information furnished is believed to be accurate and reliable. However, users should independently evaluate the suitability of and test each product selected for their own applications. Littelfuse products are not designed for, and may not be used in, all applications. Read complete Disclaimer Notice at www.littelfuse.com/disclaimer-electronics.

Littelfuse reserves the right to change limits, test conditions and dimensions.
