

Low Profile Shielded SMD Chip Power Inductor

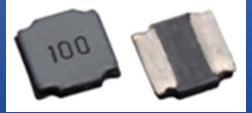

ASPI-0520



5.0 x 5.0 x 2.0mm
RoHS Compliant
MSL Level: 2

Features

- Small and low profile inductor
- High current performance
- High magnetic shield construction should actualize high resolution.
- Available for automatic mounting in tape and reel package

Applications

- Mobile phones
- HDD, DVC, DSC, PDA, LCD display

Electrical Specifications

Operating Temperature:	-25°C to +120°C (Including self-generated heat)
Storage Temperature:	-10°C to +40°C, 30% to 70% RH

Part Number	Inductance	Inductance Tolerance	DCR	DCR Tolerance	Saturation Current	Temperature Rise Current
Units	μH	%	mΩ	%	A	A
Symbol	L	M, N	DCR		Isat	Irms
ASPI-0520-1R0	1.0	N	21	±30%	4.00	3.60
ASPI-0520-1R5	1.5	N	26		3.35	3.20
ASPI-0520-2R2	2.2	N	35		2.90	2.90
ASPI-0520-3R3	3.3	M	48	±20%	2.40	2.40
ASPI-0520-4R7	4.7	M	60		2.00	2.00
ASPI-0520-5R6	5.6	M	88		1.80	1.80
ASPI-0520-6R8	6.8	M	90		1.60	1.65
ASPI-0520-100	10.0	M	120		1.30	1.45
ASPI-0520-150	15.0	M	165		1.10	1.20
ASPI-0520-220	22.0	M	260		0.90	1.00
ASPI-0520-330	33.0	M	430		0.80	0.90

Test Conditions

1. Inductance is measured in HP-4285A Precision LCR Meter.
2. RDC is measured in DU-5011 milli ohm meter.(or equivalent).
3. Isat : Based on inductance change (L/Lo : ≤ -30%)
4. Irms : Based on temperature rise (T : 40°C TYP.)
5. Test Freq: 100KHz, 1Vrms

Low Profile Shielded SMD Chip Power Inductor

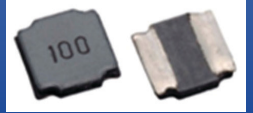

ASPI-0520



5.0 x 5.0 x 2.0mm
RoHS Compliant
MSL Level: 2

Part Number Identification

ASPI-0520--

Inductance Code
Please refer to the
Electrical Spec Table

Tolerance
N: $\pm 30\%^*$
M: $\pm 20\%^*$

Packaging
T2: Tape and Reel (2kpcs / reel)

*N for L = 1.0 ~ 2.2 μ H
*M for L = 3.3 ~ 33 μ H

Mechanical Information

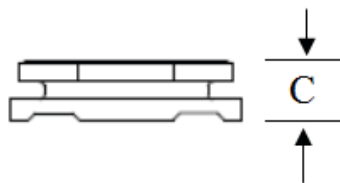
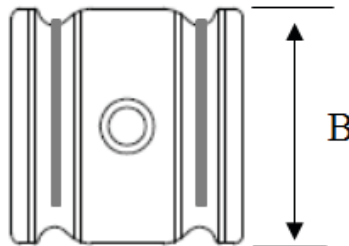
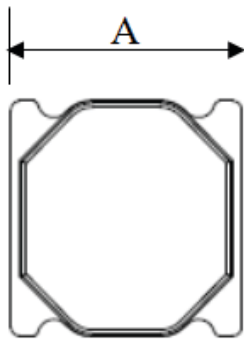

Circuit Schematic

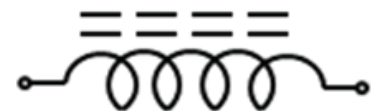

No Polarity

Recommended Land Pattern

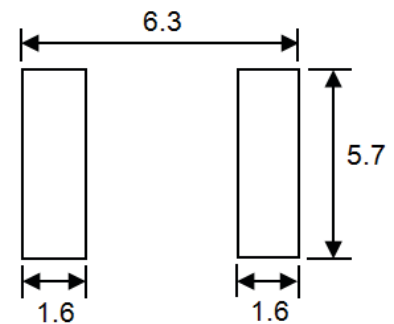

A	B	C Max
5.0 \pm 0.2	5.0 \pm 0.2	2.0

Dimensions: mm



5101 Hidden Creek Ln Spicewood TX 78669
Phone: 512-371-6159 | Fax: 512-351-8858
For terms and conditions of sales, please visit:
www.abracon.com

REVISED: 06-25-20

ABRACON IS
ISO9001-2015
CERTIFIED

Low Profile Shielded SMD Chip Power Inductor

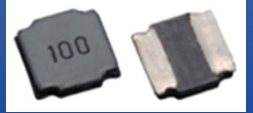

ASPI-0520



5.0 x 5.0 x 2.0mm
RoHS Compliant
MSL Level: 2

Reflow Profile

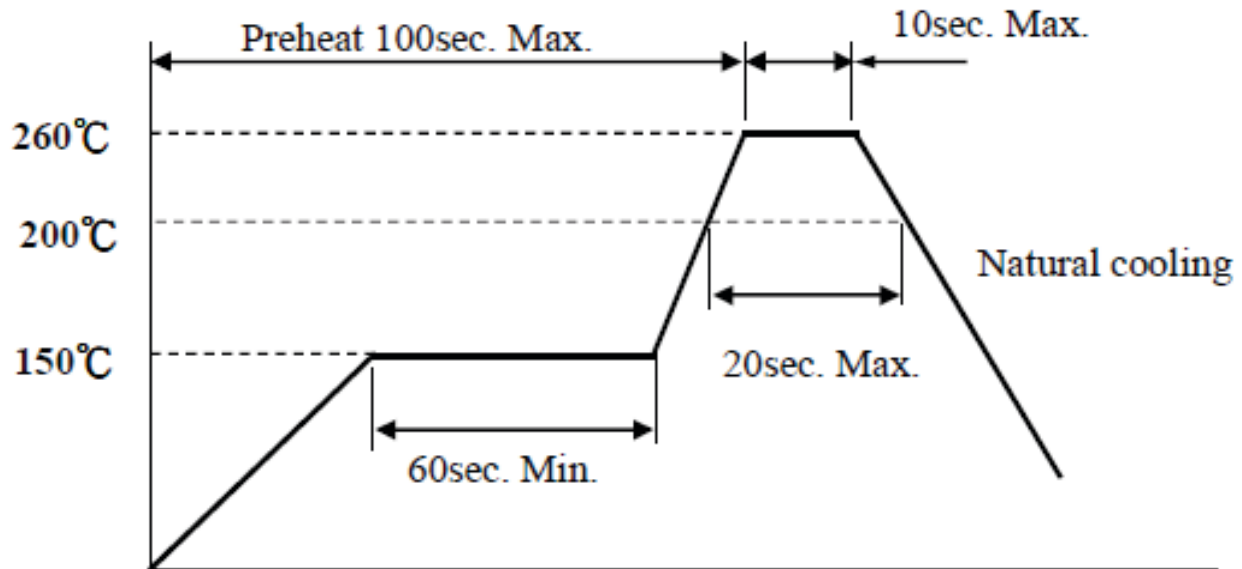

Low Profile Shielded SMD Chip Power Inductor

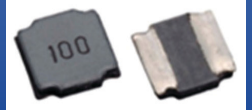

ASPI-0520



5.0 x 5.0 x 2.0mm
RoHS Compliant
MSL Level: 2

Packaging

T2= 2,000pcs/reel

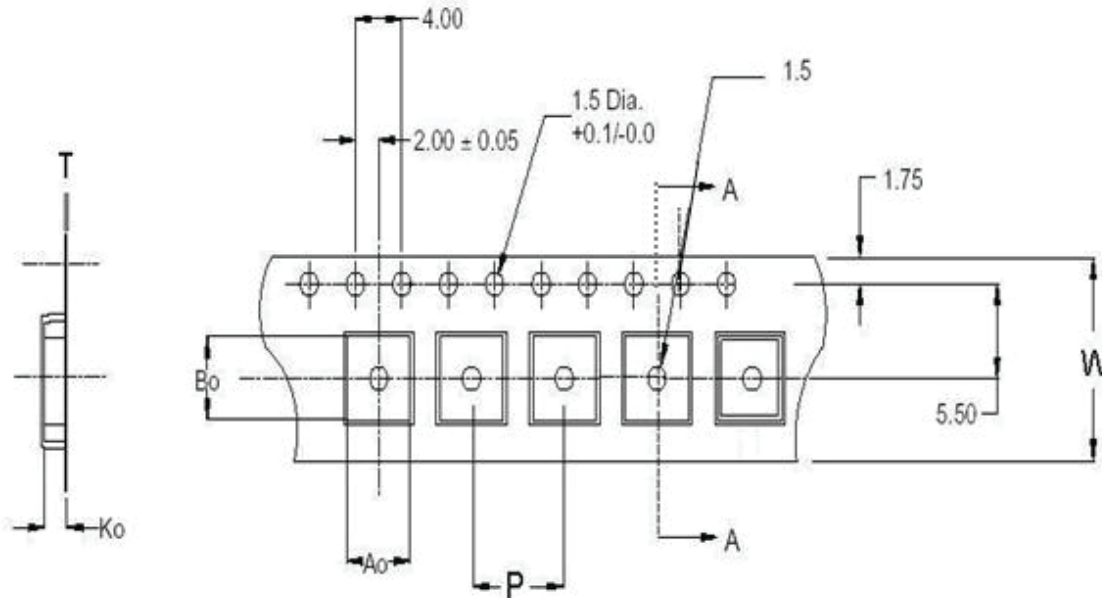

A_0	5.40
B_0	5.40
K_0	2.25
W	12.00
P	8.00
T	0.40

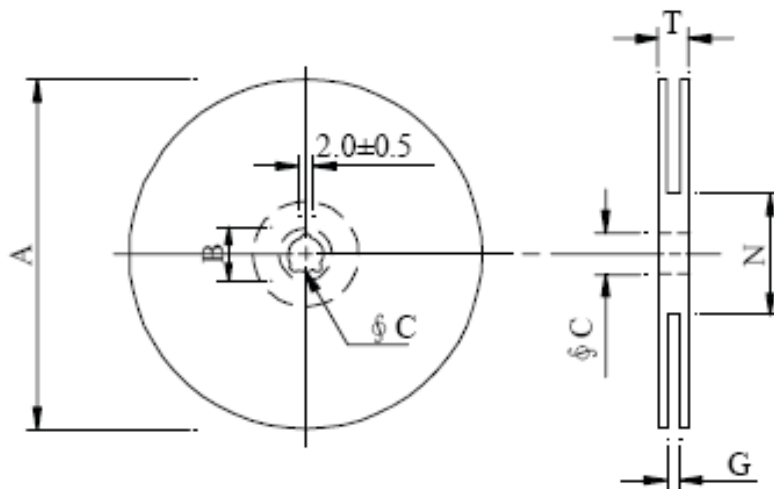

A	330
B	21.0±0.8
C	13.5±0.5
G	12.6
N	99.5
T	17.2

Dimensions: mm

ATTENTION: Abracon LLC's products are COTS – Commercial-Off-The-Shelf products; suitable for Commercial, Industrial and, where designated, Automotive Applications. Abracon's products are not specifically designed for Military, Aviation, Aerospace, Life-dependent Medical applications or any application requiring high reliability where component failure could result in loss of life and/or property. For applications requiring high reliability and/or presenting an extreme operating environment, written consent and authorization from Abracon LLC is required. Please contact Abracon LLC for more information.



5101 Hidden Creek Ln Spicewood TX 78669
Phone: 512-371-6159 | Fax: 512-351-8858
For terms and conditions of sales, please visit:
www.abracon.com

REVISED: 06-25-20

ABRACON IS
ISO9001-2015
CERTIFIED