

NXFT15XV502FEAB050

In Production Recommended RoHS REACH

Applications

Unsuitable Applications	Please be sure to read and comply with these "Precautions for use."
Specific Applications	Consumer equipment, Industrial Equipment Please refer to Our Website and specifications, etc. for information about the performance, functions, quality, management, and safety required for the above applications, and use Products after confirming the performance and reliability of the actual Product.

Packaging Information

Packaging	Specifications	Standard Packing Quantity
B	Bulk(Bag)	1000

Features

1. High accuracy and high sensibility temperature sensing is available by the small size and high accuracy NTC Thermistor.
2. Narrow space temperature sensing is available by the small sensing head and the thin lead wire.
3. You can choose the optimum length according to the design layout.
4. This product is compatible with our 0402 (EIA) size chip Thermistor.
5. Excellent long time aging stability
6. This is halogen free product (Cl= max.900ppm, Br=max.900ppm and Cl+Br=max.1500ppm).
7. Lead is not contained in the product.

Appearance & Shape

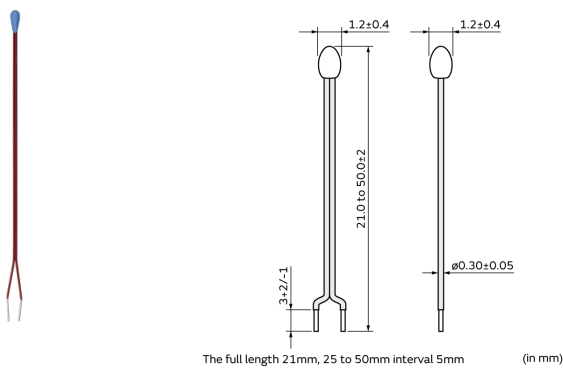

Attention
 1. This datasheet is downloaded from the website of Murata Manufacturing Co., Ltd. Therefore, its specifications are subject to change or our products in it may be discontinued without advance notice. Please check with our sales representatives or product engineers before ordering.
 2. This datasheet has only typical specifications because there is no space for detailed specifications.
 Therefore, please review our product specifications or consult the approval sheet for product specifications before ordering.

NXFT15XV502FEAB050



Specifications

Resistance (25°C)	5kΩ
Resistance Value Tolerance (at 25°C)	±1%
B-Constant (25/50°C)	3936K
B-Constant (25/50°C) Tolerance	±1%
B-Constant(25/80°C) (Reference Value)	3971K
B-Constant(25/85°C) (Reference Value)	3977K
B-Constant(25/100°C) (Reference Value)	3989K
Maximum Operating Current (25°C)	0.11mA
Rated Electric Power (25°C)	3.0mW
Typical Dissipation Constant (25°C)	0.6mW/°C
Operating Temperature Range	-40°C to 125°C
Thermal Time Constant	3s
Lead Shape	Lead Wire type(Non-Twist type)
Size Code (in mm)	050 = 50mm
Size Code (in inch)	050 = 50mm
Shape	Lead
Mass	0.051g
MSL	N

Attention

1.This datasheet is downloaded from the website of Murata Manufacturing Co., Ltd. Therefore, it's specifications are subject to change or our products in it may be discontinued without advance notice. Please check with our sales representatives or product engineers before ordering.

2.This datasheet has only typical specifications because there is no space for detailed specifications.

Therefore, please review our product specifications or consult the approval sheet for product specifications before ordering.

NXFT15XV502FEAB050

Product Data

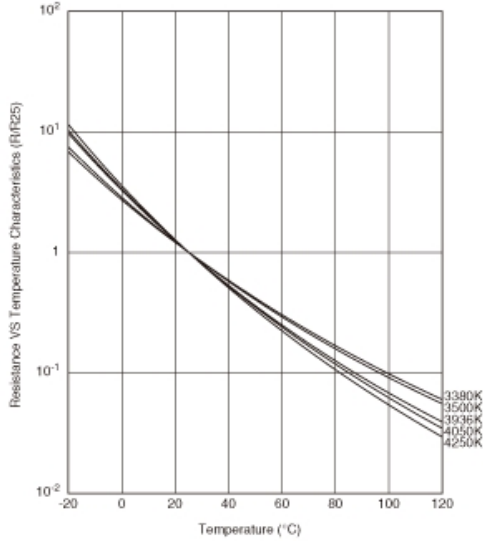

Resistance-Temperature Characteristics

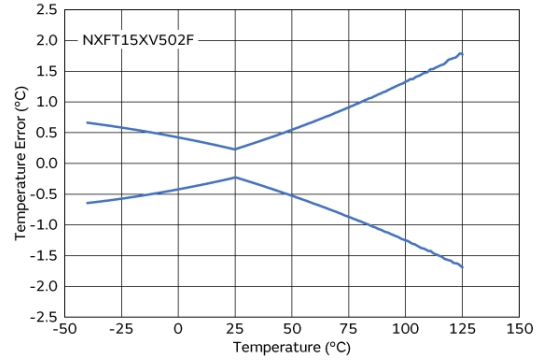

Temperature Error Characteristics

Attention

- 1.This datasheet is downloaded from the website of Murata Manufacturing Co., Ltd. Therefore, it's specifications are subject to change or our products in it may be discontinued without advance notice. Please check with our sales representatives or product engineers before ordering.
 - 2.This datasheet has only typical specifications because there is no space for detailed specifications.
- Therefore, please review our product specifications or consult the approval sheet for product specifications before ordering.