

Si/SiC Hybrid Module – EliteSiC, 3 Channel Symmetric Boost 1000 V, 150 A IGBT, 1200 V, 30 A SiC Diode, Q2 Package

NXH450B100H4Q2F2, NXH450B100H4Q2F2PG-R

Description

The NXH450B100H4Q2 is a Si/SiC Hybrid three channel symmetric boost module. Each channel contains two 1000 V, 150 A IGBTs, two 1200 V, 30 A SiC diodes and two 1600 V, 30 A bypass diodes. The module contains an NTC thermistor.

Features

- Silicon/SiC Hybrid Technology Maximizes Power Density
- Low Switching Loss Reduces System Power Dissipation
- Low Inductive Layout
- Press-fit and Solder Pin Options
- This Device is Pb-Free, Halogen Free and is RoHS Compliant

Typical Applications

- Solar Inverter
- Uninterruptible Power Supplies

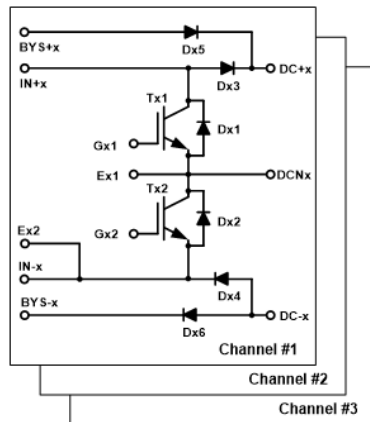
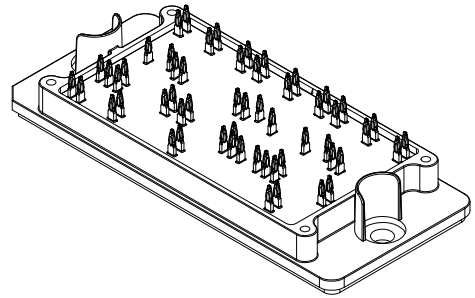
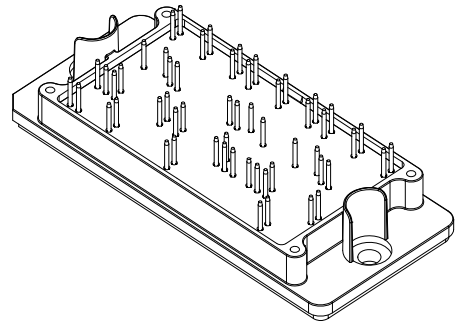

Figure 1. NXH450B100H4Q2F2PG/PG-R/SG Schematic Diagram



Q2BOOST 3-CHANNEL PRESS FIT PINS
CASE 180BG



Q2BOOST 3-CHANNEL SOLDER PINS
CASE 180BR

MARKING DIAGRAM

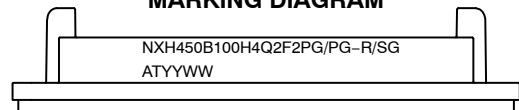

- G = Pb-Free Package
- AT = Assembly & Test Site Code
- YYWW = Year and Work Week Code
- NXH450B100H4Q2F2PG/PG-R/SG = Specific Device Code

PIN CONNECTIONS

See details pin connections on page 2 of this data sheet.

ORDERING INFORMATION

See detailed ordering and shipping information on page 5 of this data sheet.

NXH450B100H4Q2F2, NXH450B100H4Q2F2PG-R

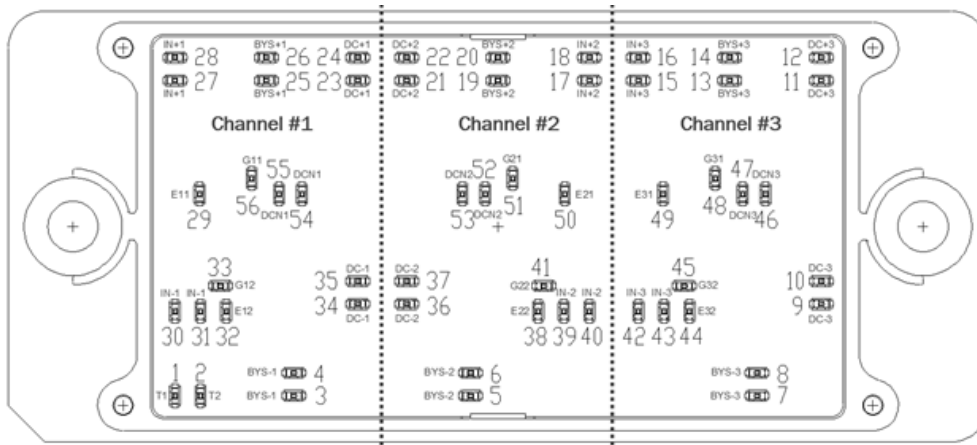

Figure 2. Pins Assignments

ABSOLUTE MAXIMUM RATINGS (Note 1) ($T_j = 25^\circ\text{C}$ unless otherwise noted)

Rating	Symbol	Value	Unit
IGBT (Tx1, Tx2)			
Collector-Emitter Voltage	V_{CES}	1000	V
Gate-Emitter Voltage	V_{GE}	± 20	V
Positive Transient Gate-Emitter Voltage ($T_{pulse} = 5 \mu\text{s}$, $D < 0.10$)		30	
Continuous Collector Current (@ $V_{GE} = 20 \text{ V}$, $T_C = 80^\circ\text{C}$)	I_C	101	A
Pulsed Peak Collector Current @ $T_C = 80^\circ\text{C}$ ($T_J = 150^\circ\text{C}$)	$I_{C(Pulse)}$	303	A
Power Dissipation ($T_C = 80^\circ\text{C}$, $T_J = 150^\circ\text{C}$)	P_{tot}	234	W
Minimum Operating Junction Temperature	T_{JMIN}	-40	$^\circ\text{C}$
Maximum Operating Junction Temperature (Note 2)	T_{JMAX}	150	$^\circ\text{C}$
IGBT INVERSE DIODE (Dx1, Dx2) AND BYPASS DIODE (Dx5, Dx6)			
Peak Repetitive Reverse Voltage	V_{RRM}	1600	V
Continuous Forward Current @ $T_C = 80^\circ\text{C}$	I_F	36	A
Repetitive Peak Forward Current ($T_J = 150^\circ\text{C}$, T_J limited by T_{Jmax})	I_{FRM}	108	A
Maximum Power Dissipation @ $T_C = 80^\circ\text{C}$ ($T_J = 150^\circ\text{C}$)	P_{tot}	79	W
Minimum Operating Junction Temperature	T_{JMIN}	-40	$^\circ\text{C}$
Maximum Operating Junction Temperature	T_{JMAX}	150	$^\circ\text{C}$
SILICON CARBIDE SCHOTTKY DIODE (Dx3, Dx4)			
Peak Repetitive Reverse Voltage	V_{RRM}	1200	V
Continuous Forward Current @ $T_C = 80^\circ\text{C}$	I_F	36	A
Repetitive Peak Forward Current ($T_J = 150^\circ\text{C}$, T_J limited by T_{Jmax})	I_{FRM}	108	A
Maximum Power Dissipation @ $T_C = 80^\circ\text{C}$ ($T_J = 150^\circ\text{C}$)	P_{tot}	104	W
Minimum Operating Junction Temperature	T_{JMIN}	-40	$^\circ\text{C}$
Maximum Operating Junction Temperature	T_{JMAX}	175	$^\circ\text{C}$

Stresses exceeding those listed in the Maximum Ratings table may damage the device. If any of these limits are exceeded, device functionality should not be assumed, damage may occur and reliability may be affected.

1. Refer to ELECTRICAL CHARACTERISTICS, RECOMMENDED OPERATING RANGES and/or APPLICATION INFORMATION for Safe Operating parameters.
2. Qualification at 175°C per discrete TO247.

NXH450B100H4Q2F2, NXH450B100H4Q2F2PG-R

THERMAL AND INSULATION PROPERTIES (Note 3) ($T_j = 25^\circ\text{C}$ unless otherwise noted)

Rating	Symbol	Value	Unit
--------	--------	-------	------

THERMAL PROPERTIES

Operating Temperature under Switching Condition	T_{VJOP}	-40 to ($T_{jmax} - 25$)	$^\circ\text{C}$
Storage Temperature Range	T_{stg}	-40 to 125	$^\circ\text{C}$

THERMAL PROPERTIES

Isolation Test Voltage, $t = 2$ sec, 50 Hz (Note 4)	V_{is}	4000	V_{RMS}
Creepage Distance		12.7	Mm
Comparative Tracking Index	CTI	>600	

3. Refer to ELECTRICAL CHARACTERISTICS, RECOMMENDED OPERATING RANGES and/or APPLICATION INFORMATION for Safe Operating parameters.
4. 4000 $V_{AC_{RMS}}$ for 1 second duration is equivalent to 3333 $V_{AC_{RMS}}$ for 1 minute duration.

NXH450B100H4Q2F2, NXH450B100H4Q2F2PG-R

ELECTRICAL CHARACTERISTICS (Note 5) ($T_J = 25^\circ\text{C}$ unless otherwise noted)

Parameter	Test Conditions	Symbol	Min	Typ	Max	Unit	
IGBT (Tx1, Tx2)							
Collector-Emitter Breakdown Voltage	$V_{GE} = 0\text{ V}, I_C = 2\text{ mA}$	$V_{(BR)CES}$	1000	–	–	V	
Collector-Emitter Saturation Voltage	$V_{GE} = 15\text{ V}, I_C = 150\text{ A}, T_C = 25^\circ\text{C}$	V_{CESAT}	–	1.70	2.25	V	
	$V_{GE} = 15\text{ V}, I_C = 150\text{ A}, T_C = 150^\circ\text{C}$		–	2.03	–		
Gate-Emitter Threshold Voltage	$V_{GE} = V_{CE}, I_C = 150\text{ mA}$	$V_{GE(TH)}$	4.1	4.66	5.7	V	
Collector-Emitter Cutoff Current	$V_{GE} = 0\text{ V}, V_{CE} = 1000\text{ V}$	I_{CES}	–	–	600	μA	
Gate Leakage Current	$V_{GE} = \pm 20\text{ V}, V_{CE} = 0\text{ V}$	I_{GES}	–	–	± 800	nA	
Turn-On Delay Time	$T_J = 25^\circ\text{C}$ $V_{CE} = 600\text{ V}, I_C = 50\text{ A}$ $V_{GE} = -8\text{ V}, +15\text{ V}, R_G = 4\ \Omega$	$t_{d(on)}$	–	28	–	ns	
Rise Time		t_r	–	10	–		
Turn-Off Delay Time		$t_{d(off)}$	–	157	–		
Fall time		t_f	–	22	–		
Turn on Switching Loss		E_{on}	–	403	–		μJ
Turn off Switching Loss		E_{off}	–	1651	–		
Turn-On Delay Time	$T_J = 125^\circ\text{C}$ $V_{CE} = 600\text{ V}, I_C = 50\text{ A}$ $V_{GE} = -8\text{ V}, +15\text{ V}, R_G = 4\ \Omega$	$t_{d(on)}$	–	27	–	ns	
Rise Time		t_r	–	12	–		
Turn-Off Delay Time		$t_{d(off)}$	–	192	–		
Fall time		t_f	–	32	–		
Turn on Switching Loss		E_{on}	–	594	–		μJ
Turn off Switching Loss		E_{off}	–	2138	–		
Input Capacitance	$V_{CE} = 20\text{ V}, V_{GE} = 0\text{ V}, f = 1\text{ MHz}$	C_{ies}	–	9342	–	pF	
Output Capacitance		C_{oes}	–	328	–		
Reverse Transfer Capacitance		C_{res}	–	52	–		
Gate Charge	$V_{CE} = 600\text{ V}, V_{GE} = 15\text{ V}, I_C = 75\text{ A}$	Q_g	–	252	–	nC	
Thermal Resistance – Chip-to-Heatsink	Thermal grease, Thickness = 2.1 Mil \pm 2% $\lambda = 2.9\text{ W/mK}$	R_{thJH}	–	0.45	–	K/W	
Thermal Resistance – Chip-to-Case		R_{thJC}	–	0.30	–	K/W	

IGBT INVERSE DIODE (Dx1, Dx2) AND BYPASS DIODE (Dx5, Dx6)

Diode Forward Voltage	$I_F = 30\text{ A}, T_J = 25^\circ\text{C}$	V_F	–	1.04	1.7	V
	$I_F = 30\text{ A}, T_J = 150^\circ\text{C}$		–	0.94	–	
Thermal Resistance – Chip-to-Heatsink	Thermal grease, Thickness = 2.1 Mil \pm 2% $\lambda = 2.9\text{ W/mK}$	R_{thJH}	–	1.09	–	K/W
Thermal Resistance – Chip-to-Case		R_{thJC}	–	0.89	–	K/W

NXH450B100H4Q2F2, NXH450B100H4Q2F2PG-R

ELECTRICAL CHARACTERISTICS (Note 5) ($T_J = 25^\circ\text{C}$ unless otherwise noted) (continued)

Parameter	Test Conditions	Symbol	Min	Typ	Max	Unit
SIC DIODE (Dx3, Dx4)						
Diode Reverse Leakage Current	$V_R = 1200\text{ V}, T_J = 25^\circ\text{C}$	I_R	–	–	600	μA
Diode Forward Voltage	$I_F = 30\text{ A}, T_J = 25^\circ\text{C}$	V_F	–	1.42	1.7	V
	$I_F = 30\text{ A}, T_J = 150^\circ\text{C}$		–	1.85	–	
Reverse Recovery Time	$T_J = 25^\circ\text{C}$ $V_{DS} = 600\text{ V}, I_C = 50\text{ A}$ $V_{GE} = -8\text{ V}, 15\text{ V}, R_G = 4\ \Omega$	t_{rr}	–	20	–	ns
Reverse Recovery Charge		Q_{rr}	–	88	–	nC
Peak Reverse Recovery Current		I_{RRM}	–	10	–	A
Peak Rate of Fall of Recovery Current		di/dt	–	4200	–	$\text{A}/\mu\text{s}$
Reverse Recovery Energy		E_{rr}	–	38	–	μJ
Reverse Recovery Time		$T_J = 125^\circ\text{C}$ $V_{DS} = 600\text{ V}, I_C = 50\text{ A}$ $V_{GE} = -8\text{ V}, 15\text{ V}, R_G = 4\ \Omega$	t_{rr}	–	19	–
Reverse Recovery Charge	Q_{rr}		–	87	–	nC
Peak Reverse Recovery Current	I_{RRM}		–	9	–	A
Peak Rate of Fall of Recovery Current	di/dt		–	3154	–	$\text{A}/\mu\text{s}$
Reverse Recovery Energy	E_{rr}		–	35	–	μJ
Thermal Resistance – Chip-to-Heatsink	Thermal grease, Thickness = 2.1 Mil \pm 2% $\lambda = 2.9\text{ W/mK}$		R_{thJH}	–	0.97	–
Thermal Resistance – Chip-to-Case		R_{thJC}	–	0.67	–	K/W

THERMISTOR CHARACTERISTICS

Nominal Resistance		R_{25}	–	22	–	$\text{k}\Omega$
Nominal Resistance	$T = 100^\circ\text{C}$	R_{100}	–	1486	–	Ω
Deviation of R25		$\Delta R/R$	-5	–	5	%
Power Dissipation		P_D	–	200	–	mW
Power Dissipation Constant			–	2	–	mW/K
B-Value	B (25/50), tolerance $\pm 3\%$		–	3950	–	K
B-Value	B (25/100), tolerance $\pm 3\%$		–	3998	–	K

Product parametric performance is indicated in the Electrical Characteristics for the listed test conditions, unless otherwise noted. Product performance may not be indicated by the Electrical Characteristics if operated under different conditions.

5. Refer to ELECTRICAL CHARACTERISTICS, RECOMMENDED OPERATING RANGES and/or APPLICATION INFORMATION for Safe Operating parameters.

PACKAGE MARKING AND ORDERING INFORMATION

Orderable Part Number	Marking	Package	Shipping
NXH450B100H4Q2F2PG, NXH450B100H4Q2F2PG-R PRESS FIT PINS	NXH450B100H4Q2F2PG, NXH450B100H4Q2F2PG-R	Q2BOOST – Case 180BG (Pb-Free and Halide-Free Press Fit Pins)	12 Units / Blister Tray
NXH450B100H4Q2F2SG SOLDER PINS	NXH450B100H4Q2F2SG	Q2BOOST – Case 180BR (Pb-Free and Halide-Free Solder Pins)	12 Units / Blister Tray

NXH450B100H4Q2F2, NXH450B100H4Q2F2PG-R

TYPICAL CHARACTERISTICS – IGBT, INVERSE DIODE AND BOOST DIODE

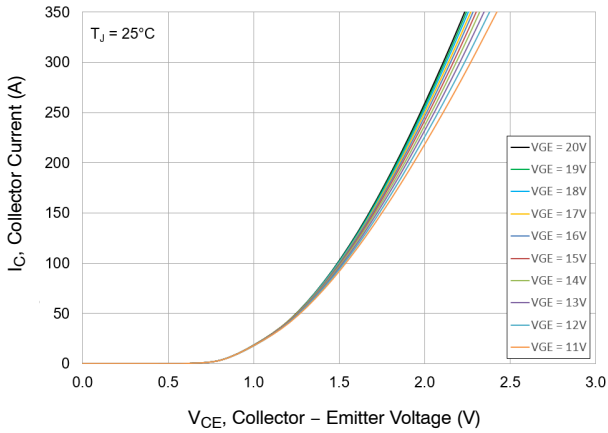

Figure 3. Typical Output Characteristics

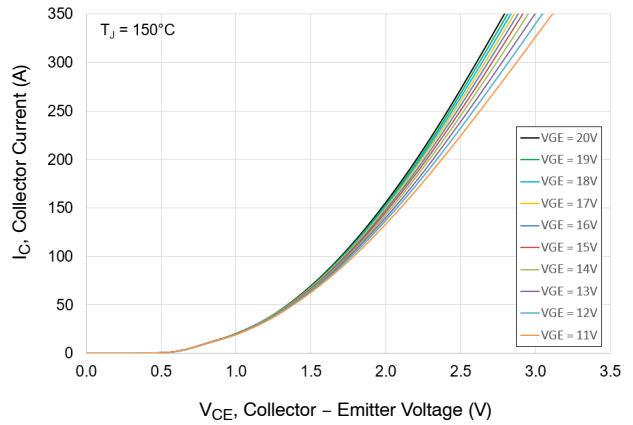

Figure 4. Typical Output Characteristics

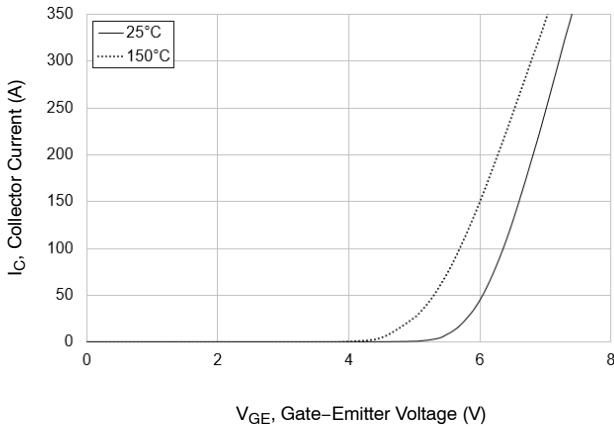

Figure 5. Transfer Characteristics

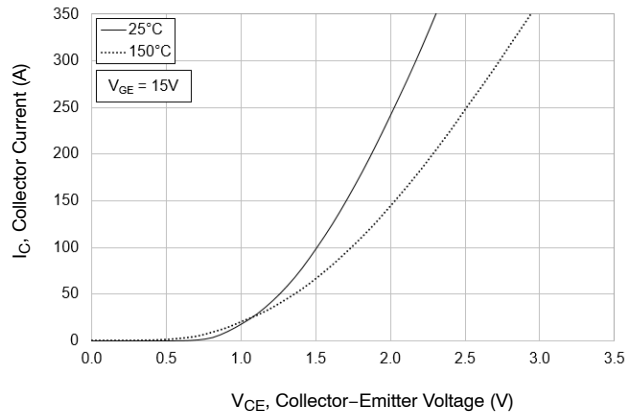

Figure 6. Typical Saturation Voltage Characteristics

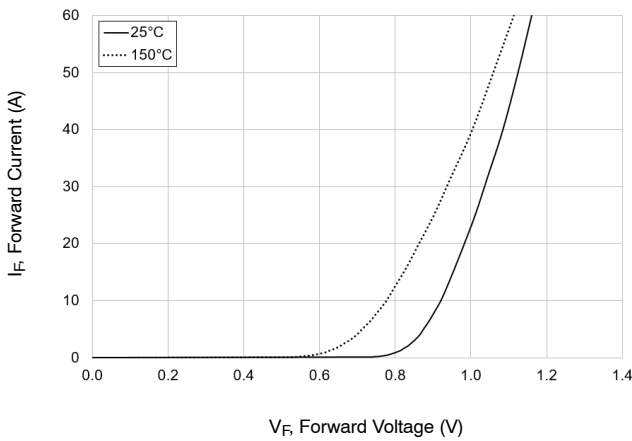

Figure 7. Inverse Diode Forward Characteristics

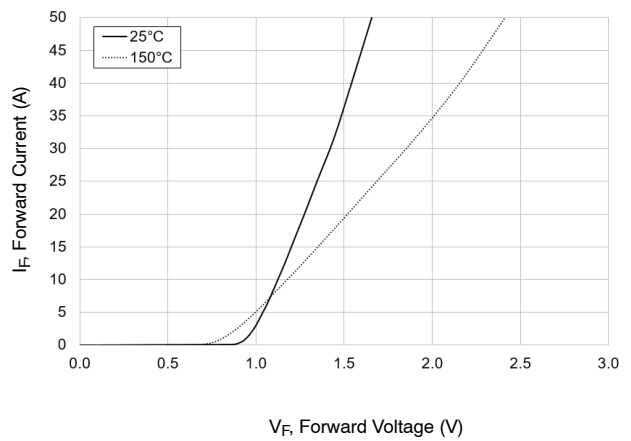

Figure 8. Boost Diode Forward Characteristics

NXH450B100H4Q2F2, NXH450B100H4Q2F2PG-R

TYPICAL CHARACTERISTICS – IGBT, INVERSE DIODE AND BOOST DIODE (CONTINUED)

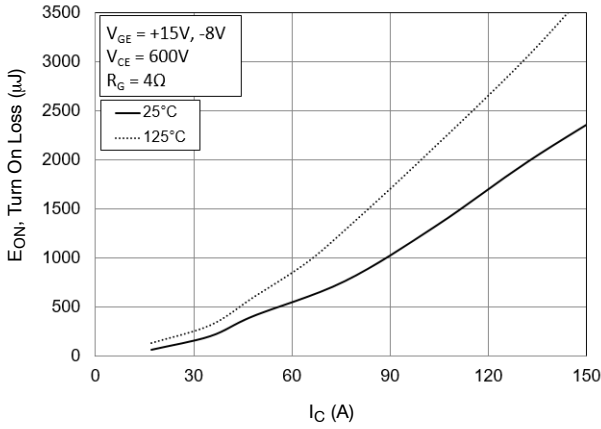

Figure 9. Typical Turn On Loss vs. I_C

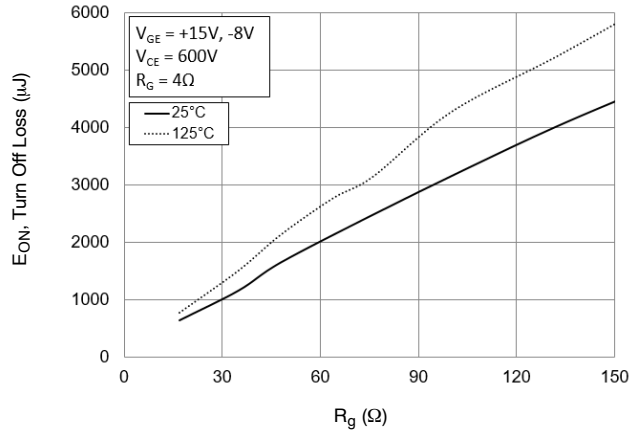

Figure 10. Typical Turn Off Loss vs. I_C

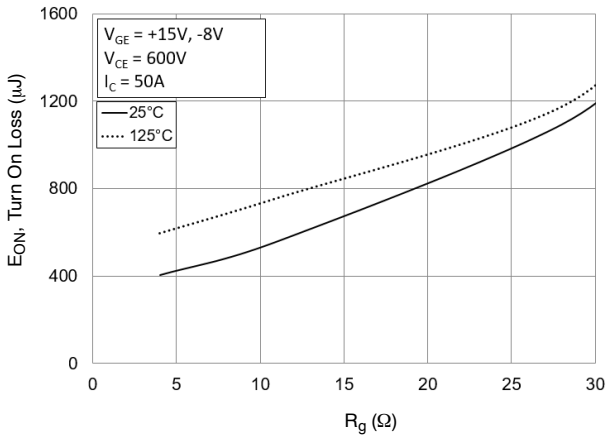

Figure 11. Typical Turn On Loss vs. R_G

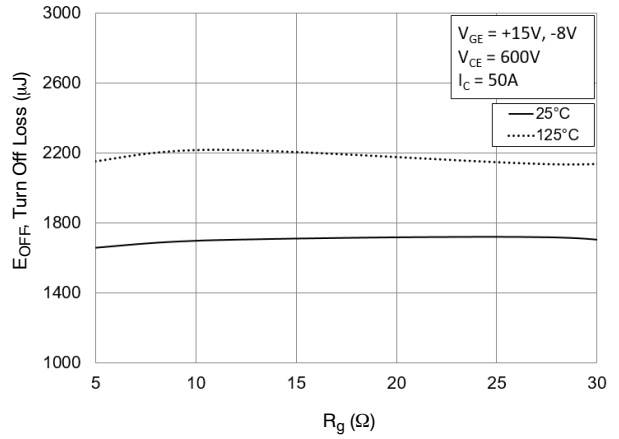

Figure 12. Typical Turn Off Loss vs. R_G

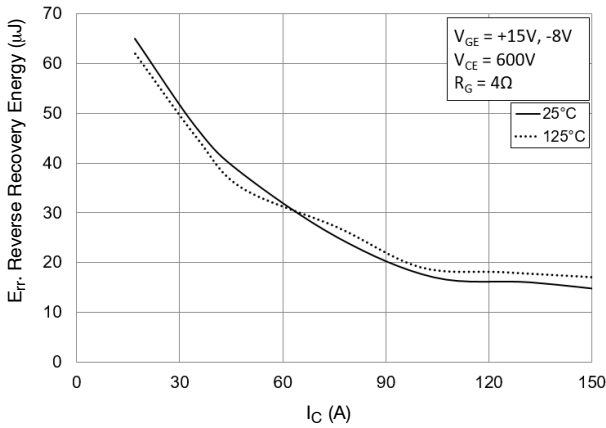

Figure 13. Typical Reverse Recovery Energy Loss vs. I_C

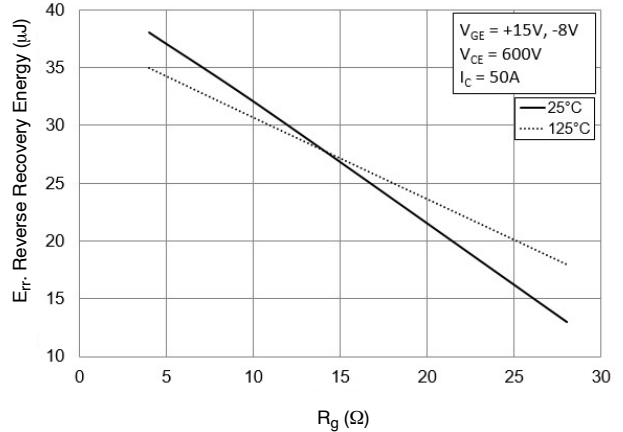

Figure 14. Typical Reverse Recovery Energy Loss vs. R_G

NXH450B100H4Q2F2, NXH450B100H4Q2F2PG-R

TYPICAL CHARACTERISTICS – IGBT, INVERSE DIODE AND BOOST DIODE (CONTINUED)

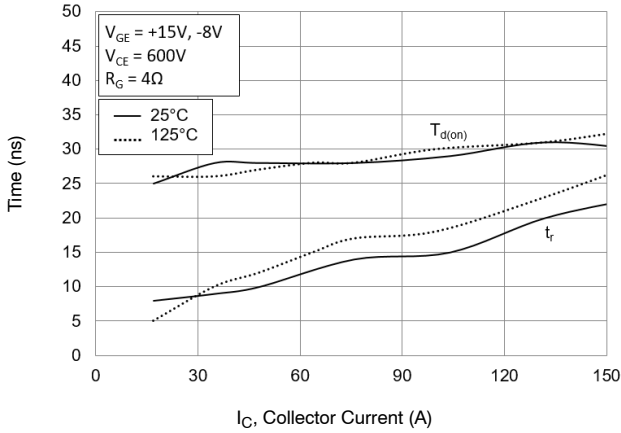

Figure 15. Typical Turn-On Switching Time vs. I_C

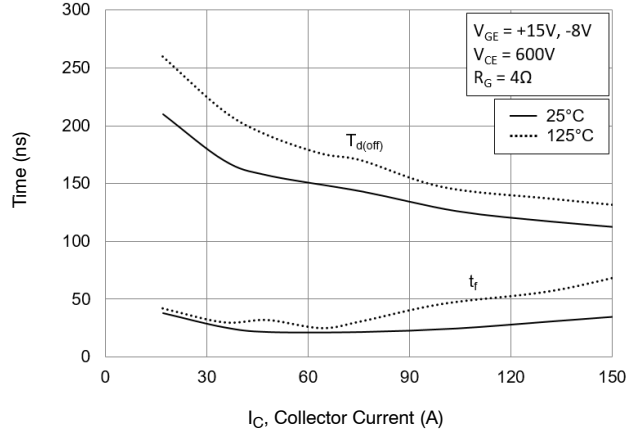

Figure 16. Typical Turn-Off Switching Time vs. I_C

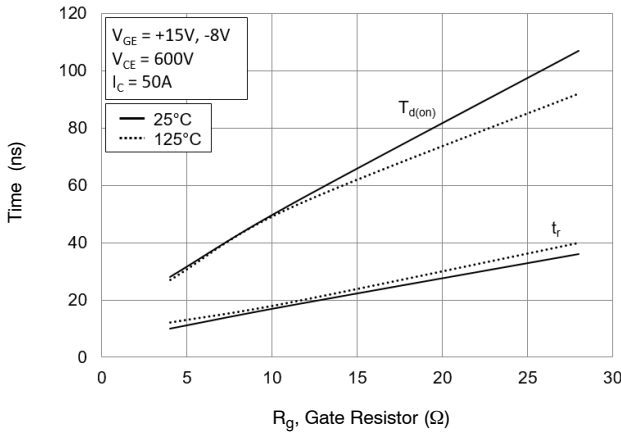

Figure 17. Typical Turn-On Switching Time vs. R_G

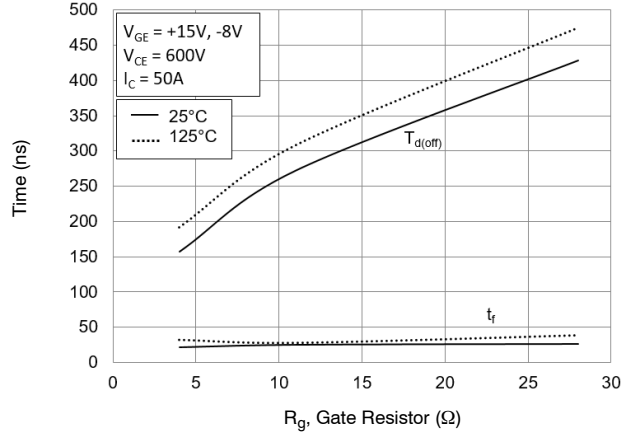

Figure 18. Typical Turn-Off Switching Time vs. R_G

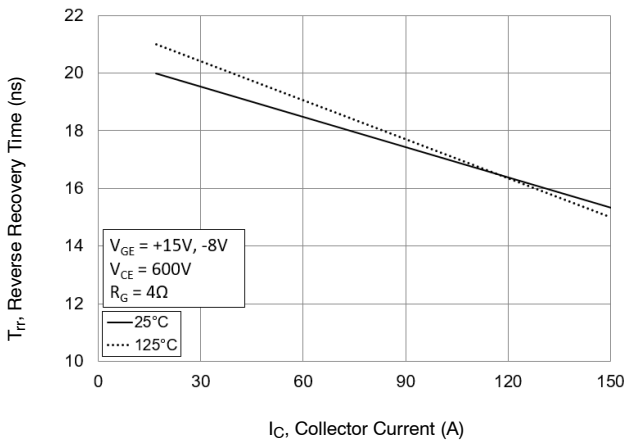

Figure 19. Typical Reverse Recovery Energy Loss vs. I_C

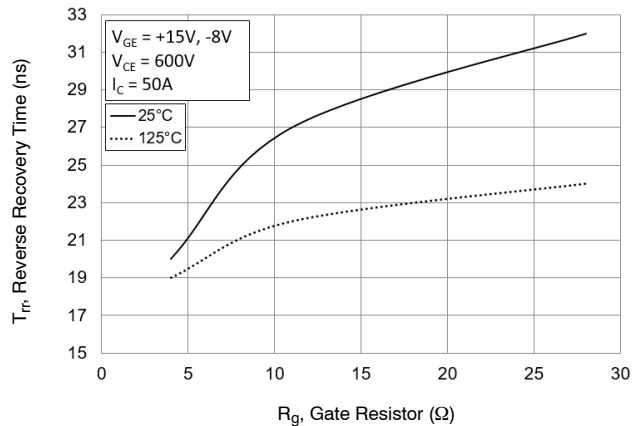

Figure 20. Typical Reverse Recovery Energy Loss vs. R_G

NXH450B100H4Q2F2, NXH450B100H4Q2F2PG-R

TYPICAL CHARACTERISTICS – IGBT, INVERSE DIODE AND BOOST DIODE (CONTINUED)

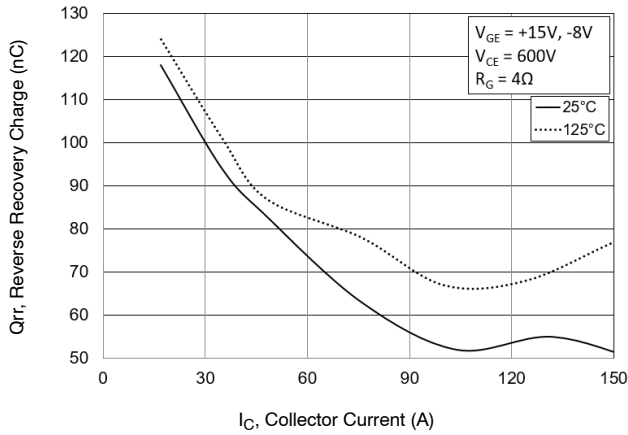

Figure 21. Typical Reverse Recovery Charge vs. I_C

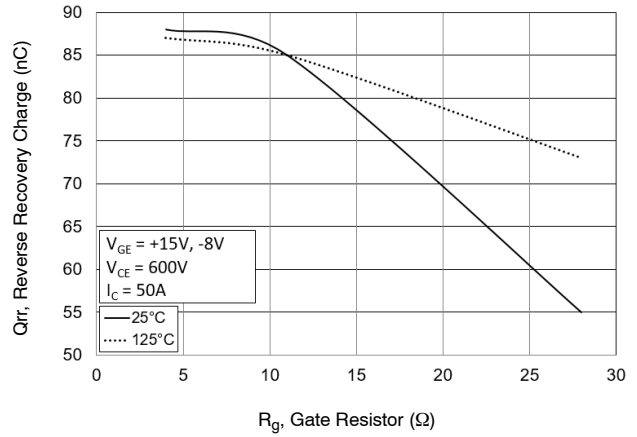

Figure 22. Typical Reverse Recovery Charge vs. R_G

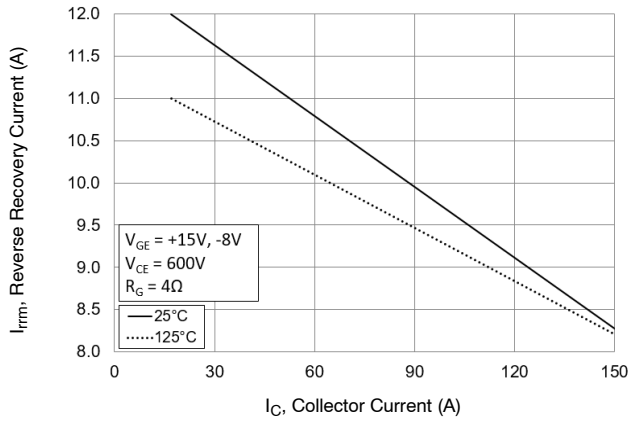

Figure 23. Typical Reverse Recovery Peak Current vs. I_C

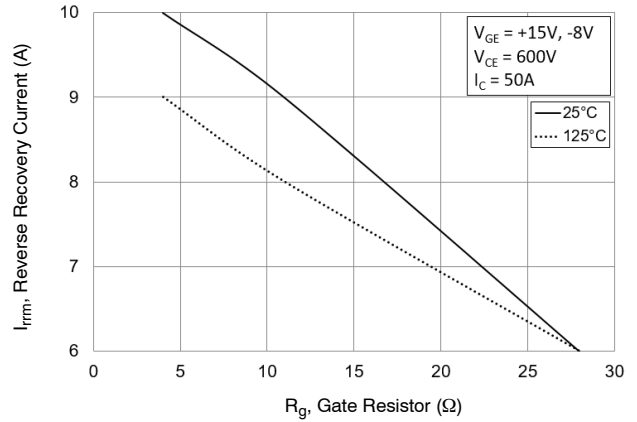

Figure 24. Typical Reverse Recovery Peak Current vs. R_G

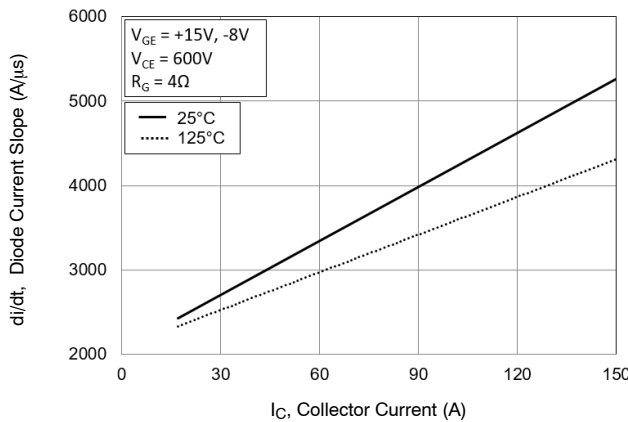

Figure 25. Typical di/dt Current Slope vs. I_C

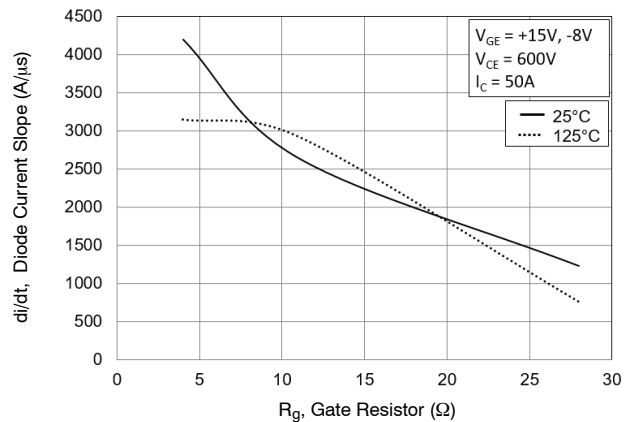

Figure 26. Typical di/dt Current Slope vs. R_G

TYPICAL CHARACTERISTICS – IGBT, INVERSE DIODE AND BOOST DIODE (CONTINUED)

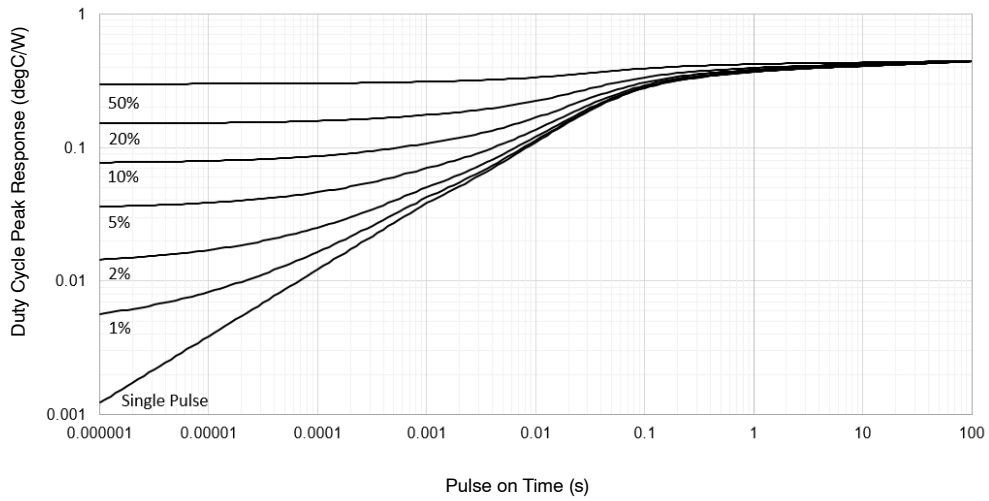

Figure 27. Transient Thermal Impedance – IGBT

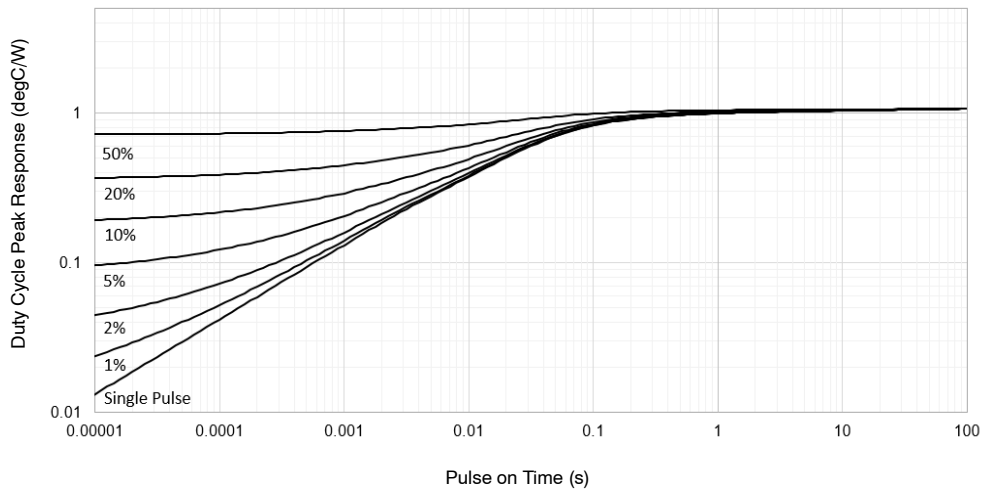

Figure 28. Transient Thermal Impedance – Inverse Diode

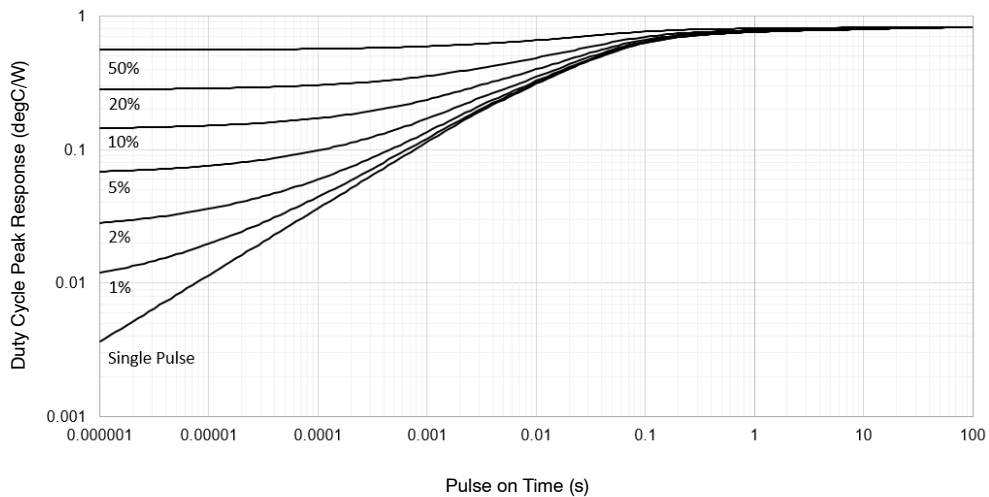

Figure 29. Transient Thermal Impedance – Boost Diode

NXH450B100H4Q2F2, NXH450B100H4Q2F2PG-R

TYPICAL CHARACTERISTICS – IGBT, INVERSE DIODE AND BOOST DIODE (CONTINUED)

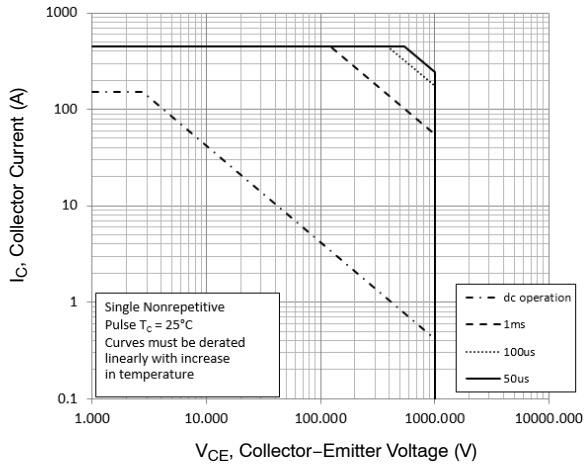

Figure 30. Forward Safe Operating Area

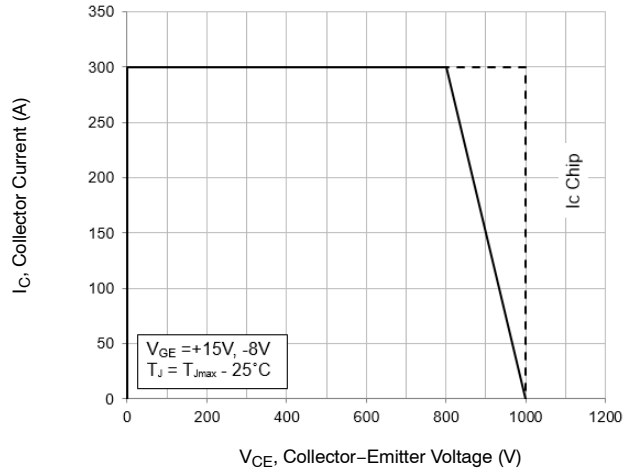

Figure 31. Reverse Safe Operating Area

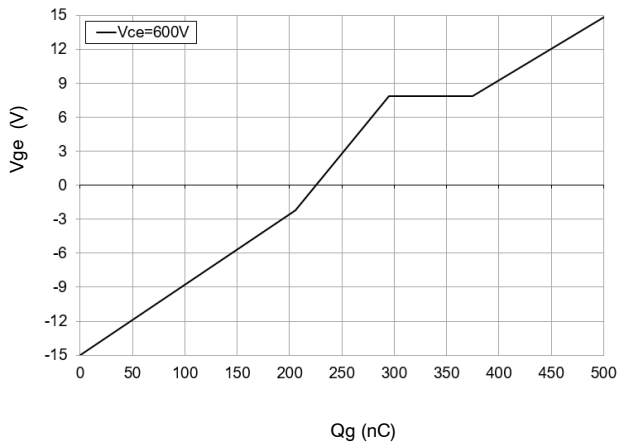

Figure 32. Gate Voltage vs. Gate Charge

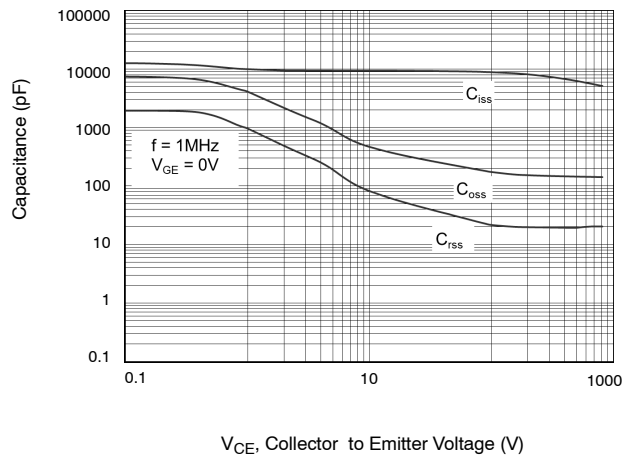

Figure 33. Capacitance Charge

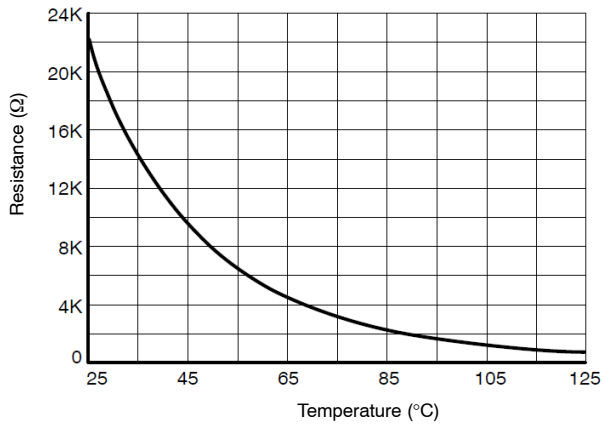

Figure 34. NTC Characteristics

MECHANICAL CASE OUTLINE PACKAGE DIMENSIONS

ON Semiconductor®



PIM56, 93x47 (PRESSFIT) CASE 180BG ISSUE O

DATE 31 JUL 2019

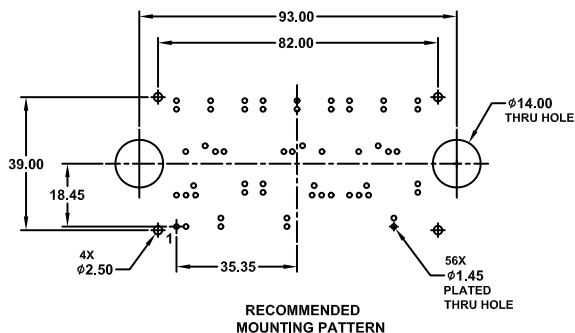
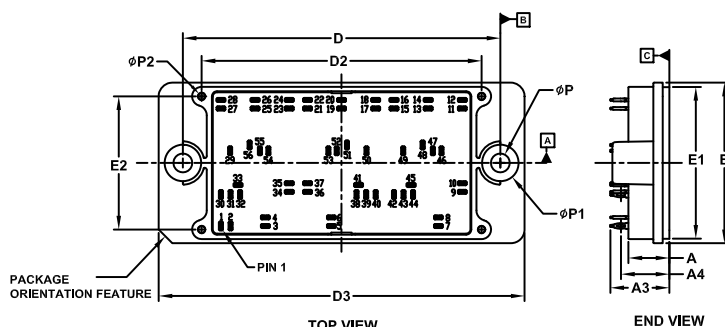
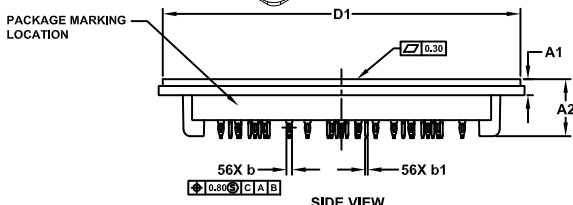
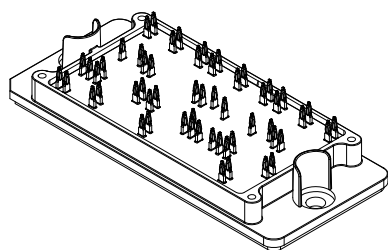

NOTES:

- DIMENSIONING AND TOLERANCING PER ASME Y14.5M, 2009.
- CONTROLLING DIMENSION: MILLIMETERS
- DIMENSIONS b AND b1 APPLY TO THE PLATED TERMINALS AND ARE MEASURED AT DIMENSION A4.
- POSITION OF THE CENTER OF THE TERMINALS IS DETERMINED FROM DATUM B THE CENTER OF DIMENSION D, X DIRECTION, AND FROM DATUM A, Y DIRECTION. POSITIONAL TOLERANCE, AS NOTED IN DRAWING, APPLIES TO EACH TERMINAL IN BOTH DIRECTIONS.
- PACKAGE MARKING IS LOCATED AS SHOWN ON THE SIDE OPPOSITE THE PACKAGE ORIENTATION FEATURES.

NOTE 4

DIM	MILLIMETERS			PIN POSITION			PIN POSITION		
	MIN.	NOM.	MAX.	PIN	X	Y	PIN	X	Y
A	11.70	12.00	12.30	1	0.00	0.00	29	2.70	22.00
A1	4.40	4.70	5.00	2	2.80	0.00	30	0.00	9.20
A2	16.40	16.70	17.00	3	13.00	0.00	31	2.80	9.20
A3	16.90	17.30	17.70	4	13.00	2.50	32	5.60	9.20
A4	13.97	14.18	14.39	5	32.35	0.00	33	5.00	12.00
b	1.61	1.66	1.71	6	32.35	2.50	34	20.00	10.00
b1	0.75	0.80	0.85	7	63.70	0.00	35	20.00	12.50
D	92.90	93.00	93.10	8	63.70	2.50	36	25.35	10.00
D1	104.45	104.75	105.05	9	70.70	10.00	37	25.35	12.50
D2	81.80	82.00	82.20	10	70.70	12.50	38	39.75	9.20
D3	106.90	107.20	107.50	11	70.70	34.40	39	42.55	9.20
E	46.70	47.00	47.30	12	70.70	36.90	40	45.35	9.20
E1	44.10	44.40	44.70	13	60.70	34.40	41	40.35	12.00
E2	38.80	39.00	39.10	14	60.70	36.90	42	50.70	9.20
P	5.40	5.50	5.60	15	50.70	34.40	43	53.50	9.20
P1	10.60	10.70	10.80	16	50.70	36.90	44	56.30	9.20
P2	1.80	2.00	2.20	17	45.35	34.40	45	55.70	12.00
				18	45.35	36.90	46	64.60	22.00
				19	35.35	34.40	47	62.10	22.00
				20	35.35	36.90	48	59.10	23.70
				21	25.35	34.40	49	53.40	22.00
				22	25.35	36.90	50	42.65	22.00
				23	20.00	34.40	51	36.95	23.70
				24	20.00	36.90	52	33.95	22.00
				25	10.00	34.40	53	31.45	22.00
				26	10.00	36.90	54	13.90	22.00
				27	0.00	34.40	55	11.40	22.00
				28	0.00	36.90	56	8.40	23.70

GENERIC MARKING DIAGRAM*

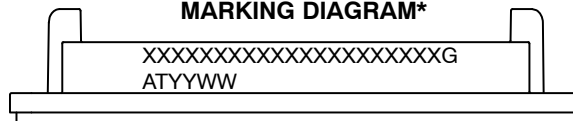

XXXXX = Specific Device Code
G = Pb-Free Package
AT = Assembly & Test Site Code
YYWW = Year and Work Week Code

*This information is generic. Please refer to device data sheet for actual part marking. Pb-Free indicator, "G" or microdot "▪", may or may not be present. Some products may not follow the Generic Marking.

DOCUMENT NUMBER:	98AON09950H	Electronic versions are uncontrolled except when accessed directly from the Document Repository. Printed versions are uncontrolled except when stamped "CONTROLLED COPY" in red.
DESCRIPTION:	PIM56 93X47 (PRESS FIT)	PAGE 1 OF 1

ON Semiconductor and ON are trademarks of Semiconductor Components Industries, LLC dba ON Semiconductor or its subsidiaries in the United States and/or other countries. ON Semiconductor reserves the right to make changes without further notice to any products herein. ON Semiconductor makes no warranty, representation or guarantee regarding the suitability of its products for any particular purpose, nor does ON Semiconductor assume any liability arising out of the application or use of any product or circuit, and specifically disclaims any and all liability, including without limitation special, consequential or incidental damages. ON Semiconductor does not convey any license under its patent rights nor the rights of others.

MECHANICAL CASE OUTLINE

PACKAGE DIMENSIONS

ON Semiconductor®

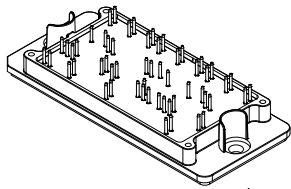

PIM56, 93x47 (SOLDER PIN)
CASE 180BR
ISSUE O

DATE 03 DEC 2019

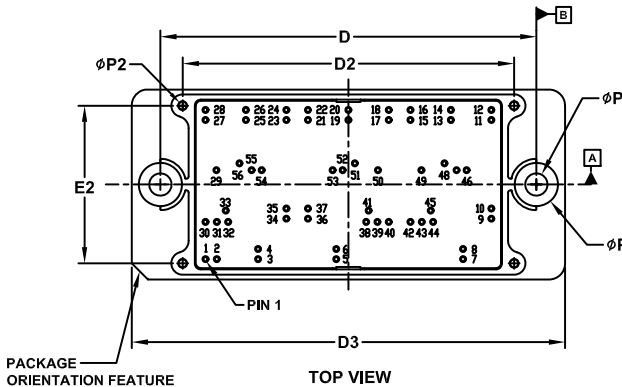
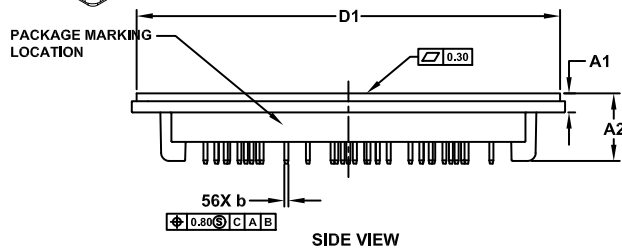

NOTES:

1. DIMENSIONING AND TOLERANCING PER ASME Y14.5M, 2009.
2. CONTROLLING DIMENSION: MILLIMETERS
3. DIMENSIONS b AND b1 APPLY TO THE PLATED TERMINALS AND ARE MEASURED AT DIMENSION A4.
4. POSITION OF THE CENTER OF THE TERMINALS IS DETERMINED FROM DATUM B THE CENTER OF DIMENSION D, X DIRECTION, AND FROM DATUM A, Y DIRECTION. POSITIONAL TOLERANCE, AS NOTED IN DRAWING, APPLIES TO EACH TERMINAL IN BOTH DIRECTIONS.
5. PACKAGE MARKING IS LOCATED AS SHOWN ON THE SIDE OPPOSITE THE PACKAGE ORIENTATION FEATURES.

DIM	MILLIMETERS		
	MIN.	NOM.	MAX.
A	11.70	12.00	12.30
A1	4.40	4.70	5.00
A2	16.40	16.70	17.00
A3	16.80	17.20	17.60
b	0.95	1.00	1.05
D	92.90	93.00	93.10
D1	104.45	104.75	105.05
D2	81.80	82.00	82.20
D3	106.90	107.20	107.50
E	46.70	47.00	47.30
E1	44.10	44.40	44.70
E2	38.80	39.00	39.10
P	5.40	5.50	5.60
P1	10.60	10.70	10.80
P2	1.80	2.00	2.20

NOTE 4

PIN	PIN POSITION		PIN	PIN POSITION	
	X	Y		X	Y
1	0.00	0.00	29	2.70	22.00
2	2.80	0.00	30	0.00	9.20
3	13.00	0.00	31	2.80	9.20
4	13.00	2.50	32	5.60	9.20
5	32.35	0.00	33	5.00	12.00
6	32.35	2.50	34	20.00	10.00
7	63.70	0.00	35	20.00	12.50
8	63.70	2.50	36	25.35	10.00
9	70.70	10.00	37	25.35	12.50
10	70.70	12.50	38	39.75	9.20
11	70.70	34.40	39	42.55	9.20
12	70.70	36.90	40	45.35	9.20
13	60.70	34.40	41	40.35	12.00
14	60.70	36.90	42	50.70	9.20
15	50.70	34.40	43	53.50	9.20
16	50.70	36.90	44	56.30	9.20
17	45.35	34.40	45	55.70	12.00
18	45.35	36.90	46	64.60	22.00
19	35.35	34.40	47	62.10	22.00
20	35.35	36.90	48	59.10	23.70
21	25.35	34.40	49	53.40	22.00
22	25.35	36.90	50	42.65	22.00
23	20.00	34.40	51	36.95	23.70
24	20.00	36.90	52	33.95	22.00
25	10.00	34.40	53	31.45	22.00
26	10.00	36.90	54	13.90	22.00
27	0.00	34.40	55	11.40	22.00
28	0.00	36.90	56	8.40	23.70

GENERIC MARKING DIAGRAM*

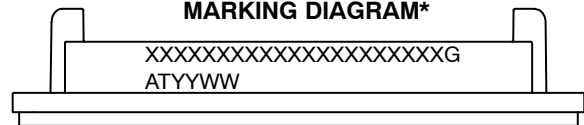

XXXXX = Specific Device Code
 G = Pb-Free Package
 AT = Assembly & Test Site Code
 YYWW = Year and Work Week Code

*This information is generic. Please refer to device data sheet for actual part marking. Pb-Free indicator, "G" or microdot "•", may or may not be present. Some products may not follow the Generic Marking.

DOCUMENT NUMBER:	98AON15231H	Electronic versions are uncontrolled except when accessed directly from the Document Repository. Printed versions are uncontrolled except when stamped "CONTROLLED COPY" in red.
DESCRIPTION:	PIM56 93X47 (SOLDER PIN)	PAGE 1 OF 1

ON Semiconductor and ON are trademarks of Semiconductor Components Industries, LLC dba ON Semiconductor or its subsidiaries in the United States and/or other countries. ON Semiconductor reserves the right to make changes without further notice to any products herein. ON Semiconductor makes no warranty, representation or guarantee regarding the suitability of its products for any particular purpose, nor does ON Semiconductor assume any liability arising out of the application or use of any product or circuit, and specifically disclaims any and all liability, including without limitation special, consequential or incidental damages. ON Semiconductor does not convey any license under its patent rights nor the rights of others.

onsemi, **Onsemi**, and other names, marks, and brands are registered and/or common law trademarks of Semiconductor Components Industries, LLC dba "**onsemi**" or its affiliates and/or subsidiaries in the United States and/or other countries. **onsemi** owns the rights to a number of patents, trademarks, copyrights, trade secrets, and other intellectual property. A listing of **onsemi**'s product/patent coverage may be accessed at www.onsemi.com/site/pdf/Patent-Marking.pdf. **onsemi** reserves the right to make changes at any time to any products or information herein, without notice. The information herein is provided "as-is" and **onsemi** makes no warranty, representation or guarantee regarding the accuracy of the information, product features, availability, functionality, or suitability of its products for any particular purpose, nor does **onsemi** assume any liability arising out of the application or use of any product or circuit, and specifically disclaims any and all liability, including without limitation special, consequential or incidental damages. Buyer is responsible for its products and applications using **onsemi** products, including compliance with all laws, regulations and safety requirements or standards, regardless of any support or applications information provided by **onsemi**. "Typical" parameters which may be provided in **onsemi** data sheets and/or specifications can and do vary in different applications and actual performance may vary over time. All operating parameters, including "Typicals" must be validated for each customer application by customer's technical experts. **onsemi** does not convey any license under any of its intellectual property rights nor the rights of others. **onsemi** products are not designed, intended, or authorized for use as a critical component in life support systems or any FDA Class 3 medical devices or medical devices with a same or similar classification in a foreign jurisdiction or any devices intended for implantation in the human body. Should Buyer purchase or use **onsemi** products for any such unintended or unauthorized application, Buyer shall indemnify and hold **onsemi** and its officers, employees, subsidiaries, affiliates, and distributors harmless against all claims, costs, damages, and expenses, and reasonable attorney fees arising out of, directly or indirectly, any claim of personal injury or death associated with such unintended or unauthorized use, even if such claim alleges that **onsemi** was negligent regarding the design or manufacture of the part. **onsemi** is an Equal Opportunity/Affirmative Action Employer. This literature is subject to all applicable copyright laws and is not for resale in any manner.

ADDITIONAL INFORMATION

TECHNICAL PUBLICATIONS:

Technical Library: www.onsemi.com/design/resources/technical-documentation
onsemi Website: www.onsemi.com

ONLINE SUPPORT: www.onsemi.com/support

For additional information, please contact your local Sales Representative at www.onsemi.com/support/sales