

NXRT15XV302FA5B050



Applications

Unsuitable Applications	Please be sure to read and comply with these "Precautions for use."
Specific Applications	Industrial Equipment Please refer to Our Website and specifications, etc. for information about the performance, functions, quality, management, and safety required for the above applications, and use Products after confirming the performance and reliability of the actual Product.

Packaging Information

Packaging	Specifications	Standard Packing Quantity
B	Bulk(Bag)	500

Features

1. NXR series can accurately detect temperature with NCP15 series on the head of parts.
2. The insulation coat with polyurethane on the surface of lead wire : 100VDC.
3. You can choose NTC characteristics from NCP15 series.
4. The resistance drift is small in the reliability test.
5. The production capacity is bigger and NXR is produced in almost all automation line.
6. Adopt to Sb regulation
7. UL/cULcertified product. (UL1434, File No. E137188)

Appearance & Shape

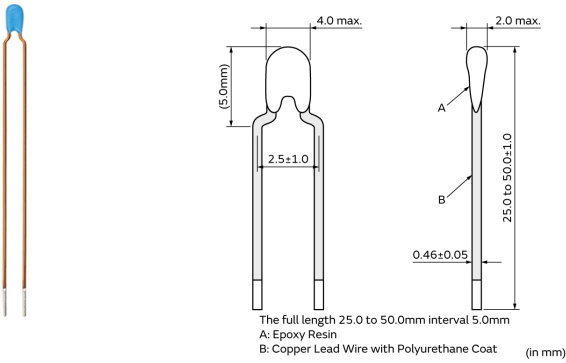

Attention

1. This datasheet is downloaded from the website of Murata Manufacturing Co., Ltd. Therefore, its specifications are subject to change or our products in it may be discontinued without advance notice. Please check with our sales representatives or product engineers before ordering.
2. This datasheet has only typical specifications because there is no space for detailed specifications.
Therefore, please review our product specifications or consult the approval sheet for product specifications before ordering.

NXRT15XV302FA5B050



Specifications

Resistance (25°C)	3kΩ
Resistance Value Tolerance (at 25°C)	±1%
B-Constant (25/50°C)	3936K
B-Constant (25/50°C) Tolerance	±1%
B-Constant(25/80°C) (Reference Value)	3971K
B-Constant(25/85°C) (Reference Value)	3977K
B-Constant(25/100°C) (Reference Value)	3989K
Maximum Operating Current (25°C)	0.29mA
Rated Electric Power (25°C)	13.0mW
Typical Dissipation Constant (25°C)	2.6mW/°C
Operating Temperature Range	-40°C to 125°C
Thermal Time Constant	4s
Lead Shape	Insulation type
Size Code (in mm)	050 = 50mm
Size Code (in inch)	050 = 50mm
Shape	Lead
Mass	0.149g
MSL	N

Attention

1.This datasheet is downloaded from the website of Murata Manufacturing Co., Ltd. Therefore, it's specifications are subject to change or our products in it may be discontinued without advance notice. Please check with our sales representatives or product engineers before ordering.

2.This datasheet has only typical specifications because there is no space for detailed specifications.

Therefore, please review our product specifications or consult the approval sheet for product specifications before ordering.

NXRT15XV302FA5B050

Product Data

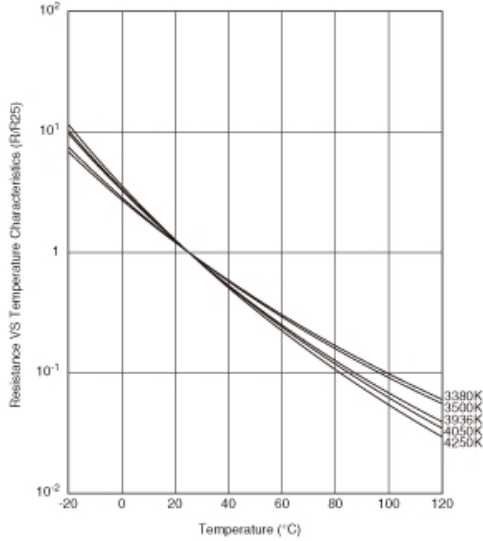

Resistance-Temperature Characteristics

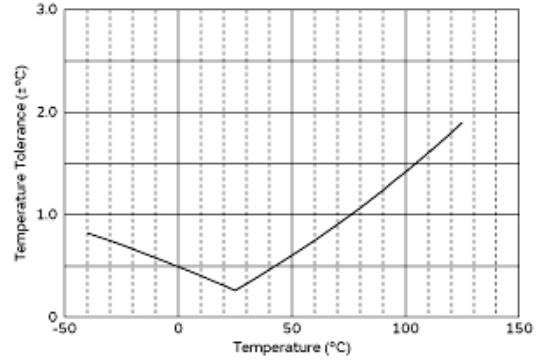

Temperature Tolerance VS. Temp.

Attention

- 1.This datasheet is downloaded from the website of Murata Manufacturing Co., Ltd. Therefore, it's specifications are subject to change or our products in it may be discontinued without advance notice. Please check with our sales representatives or product engineers before ordering.
 - 2.This datasheet has only typical specifications because there is no space for detailed specifications.
- Therefore, please review our product specifications or consult the approval sheet for product specifications before ordering.