

### Features

- Operate from 1.65V to 5.5V
- Inputs accept voltages to 5.5V
- High Noise Immunity
- Low power dissipation
- ESD Protection Exceeds JESD 22
  - 2000-V Human-Body Model (A114-A)
  - 1000-V Charged-Device Model (C101)
- SOT23-5 Package Available
- SOT353 Package Available
- SOT553 Package Available

### General Description

The SN74LVC1G00 is a 2-input NAND gate device which provides the Function  $Y = \overline{A \cdot B}$  or  $Y = \overline{A} + \overline{B}$  in positive logic.

This device has power-down protective circuit preventing device from destruction when it is powered down.

### Applications

- Voltage Level Shifting
- General Purpose Logic
- Power Down Signal Isolation
- Wide array of products such as:
  - PCs, Networking, Notebooks, Netbooks, PDAs
  - Tablet Computers, E-readers
  - Computer Peripherals, Hard Drives, CD/DVD ROM
  - TV, DVD, DVR, Set-Top Box
  - Cell Phones, Personal Navigation / GPS
  - MP3 Players, Cameras, Video Recorders

### Ordering Information

ORDER NUMBER	PACKAGE DESCRIPTION	PACKAGE OPTION
SN74LVC1G00DBVR	SOT23-5	Tape and Reel,3000
SN74LVC1G00DCKR	SOT353	Tape and Reel,3000
SN74LVC1G00DRLR	SOT553	Tape and Reel,4000

### Logic Diagram

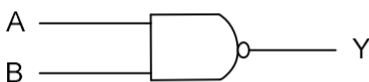

Logic symbol

### Pin Configuration

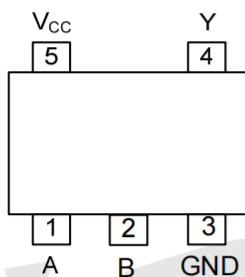

SOT-23-5  
SOT-353  
SOT-553

### Marking

SN74LVC1G00DBVR Marking:C00F

SN74LVC1G00DCKR Marking:CA5

SN74LVC1G00DRLR Marking:CA7

### Function Table

INPUT(A)	INPUT(B)	OUTPUT(Y)
H	H	L
H	L	H
L	H	H
L	L	H

Note: H: HIGH voltage level; L: LOW voltage level.

### Absolute Maximum Ratings

PARAMETER	SYMBOL	CONDITIONS	RATINGS	UNIT
Supply Voltage	$V_{CC}$		-0.5 ~ +6.5	V
Input Voltage	$V_{IN}$		-0.5 ~ +6.5	V
Output Voltage	$V_{OUT}$	Output in the Power-off state	-0.5 ~ +6.5	V
		Output in the High or Low state	-0.5 ~ $V_{CC}+0.5$	V
$V_{CC}$ or GND Current	$I_{CC}$	Output in the Power-off state	±100	mA
Continuous Output Current	$I_{OUT}$	$V_{OUT}=0\sim V_{CC}$	±50	mA
Input Clamp Current	$I_{IK}$	$V_{IN}<0$	-50	mA
Output Clamp Current	$I_{OK}$	$V_{OUT}<0$	-50	mA
Storage Temperature Range	$T_{STG}$		-65 ~ +150	°C

Note: Absolute maximum ratings are those values beyond which the device could be permanently damaged.

Absolute maximum ratings are stress ratings only and functional device operation is not implied.

### Thermal Data

PARAMETER	SYMBOL	RATINGS	UNIT
Junction to Ambient	SOT-23-5	280	°C/W
	SOT-353	350	

### Recommended Operating Conditions

PARAMETER	SYMBOL	TEST CONDITIONS	MIN	TYP	MAX	UNIT
Supply Voltage	$V_{CC}$	Operating	1.65		5.5	V
		Data retention only	1.5			V
Input Voltage	$V_{IN}$		0		5.5	V
Output Voltage	$V_{OUT}$	High or Low state	0		$V_{CC}$	V
High-level Output Current	$I_{OH}$	$V_{CC}=1.65V$			-4	mA
		$V_{CC}=2.3V$			-8	mA
		$V_{CC}=3V$			-16	mA
		$V_{CC}=3V$			-24	mA
		$V_{CC}=4.5V$			-32	mA
Low-level Output Current	$I_{OL}$	$V_{CC}=1.65V$			4	mA
		$V_{CC}=2.3V$			8	mA
		$V_{CC}=3V$			16	mA
		$V_{CC}=3V$			24	mA
		$V_{CC}=4.5V$			32	mA
Input Transition Rise or Fall Rate	$t_r / t_f$	$V_{CC}=1.8V\pm 0.15V, 2.5V\pm 0.2V$			20	ns/V
		$V_{CC}=3.3V\pm 0.3V$			10	ns/V
		$V_{CC}=5V\pm 0.5V$			5	ns/V
Operating Temperature	$T_A$		-40		+125	°C



**Electrical Characteristics**

PARAMETER	SYMBOL	TEST CONDITIONS	T <sub>A</sub> =25°C			T <sub>A</sub> =-40~+125°C			UNIT
			MIN	TYP	MAX	MIN	TYP	MAX	
High-Level Input Voltage	V <sub>IH</sub>	V <sub>CC</sub> =1.65V~1.95V	0.65			0.65			V
		V <sub>CC</sub> =2.3V~2.7V	1.7			1.7			V
		V <sub>CC</sub> =3V~3.6V	2			2			V
		V <sub>CC</sub> =4.5V~5.5V	0.7			0.7			V
Low-Level Input Voltage	V <sub>IL</sub>	V <sub>CC</sub> =1.65V~1.95V			0.35			0.35	V
		V <sub>CC</sub> =2.3V~2.7V			0.7			0.7	V
		V <sub>CC</sub> =3V~3.6V			0.8			0.8	V
		V <sub>CC</sub> =4.5V~5.5V			0.3			0.3	V
High-Level Output Voltage	V <sub>OH</sub>	V <sub>CC</sub> =1.65~5.5V, I <sub>OH</sub> =-100μA	V <sub>CC</sub> -0.1			V <sub>CC</sub> -0.1			V
		V <sub>CC</sub> =1.65V, I <sub>OH</sub> =-4mA	1.2			0.95			V
		V <sub>CC</sub> =2.3V, I <sub>OH</sub> =-8mA	1.9			1.7			V
		V <sub>CC</sub> =3.0V, I <sub>OH</sub> =-16mA	2.4			1.9			V
		V <sub>CC</sub> =3.0V, I <sub>OH</sub> =-24mA	2.3			2.0			V
		V <sub>CC</sub> =4.5V, I <sub>OH</sub> =-32mA	3.8			3.4			V
Low-Level Output Voltage	V <sub>OL</sub>	V <sub>CC</sub> =1.65~5.5V, I <sub>OL</sub> =100μA			0.1			0.1	V
		V <sub>CC</sub> =1.65V, I <sub>OL</sub> =4mA			0.45			0.7	V
		V <sub>CC</sub> =2.3V, I <sub>OL</sub> =8mA			0.3			0.45	V
		V <sub>CC</sub> =3.0V, I <sub>OL</sub> =16mA			0.4			0.6	V
		V <sub>CC</sub> =3.0V, I <sub>OL</sub> =24mA			0.55			0.80	V
		V <sub>CC</sub> =4.5V, I <sub>OL</sub> =32mA			0.55			0.80	V
Input Leakage Current	I <sub>I(LEAK)</sub>	V <sub>IN</sub> =5.5V or GND, V <sub>CC</sub> =0 ~ 5.5V			±5			±5	μA
Power OFF Leakage Current	I <sub>OFF</sub>	V <sub>IN</sub> or V <sub>OUT</sub> =5.5V, V <sub>CC</sub> =0V			±10			±10	μA
Quiescent Supply Current	I <sub>Q</sub>	V <sub>IN</sub> =V <sub>CC</sub> or GND, I <sub>OUT</sub> =0, V <sub>CC</sub> =1.65~5.5V			10			10	μA
Additional Quiescent Supply Current Per Input Pin	ΔI <sub>Q</sub>	V <sub>CC</sub> =3~5.5V, One input at V <sub>CC</sub> -0.6V, Other inputs at V <sub>CC</sub> or GND			500			500	μA

**Dynamic Characteristics** (Input: t<sub>r</sub>, t<sub>f</sub>≤3ns; P<sub>RR</sub>≤1MHz)

PARAMETER	SYMBOL	TEST CONDITIONS	T <sub>A</sub> =25°C			T <sub>A</sub> =-40~+125°C			UNIT		
			MIN	TYP	MAX	MIN	TYP	MAX			
Propagation delay from input (A or B) to output(Y)	t <sub>PLH</sub> / t <sub>PHL</sub>	V <sub>CC</sub> =1.8±0.15V	C <sub>L</sub> =15pF	R <sub>L</sub> =1MΩ	1.0		8.2	1.0		9.7	ns
		V <sub>CC</sub> =2.5±0.2V			0.5		5.4	0.5		6.9	ns
		V <sub>CC</sub> =3.3±0.3V			0.5		4.8	0.5		6.3	ns
		V <sub>CC</sub> =5±0.5V			0.5		4.4	0.5		5.9	ns
		V <sub>CC</sub> =1.8±0.15V, R <sub>L</sub> =1KΩ	C <sub>L</sub> =30pF		1.0		11	1.0		12	ns
		V <sub>CC</sub> =2.5±0.2V, R <sub>L</sub> =500Ω			0.5		7	0.5		9	ns
		V <sub>CC</sub> =3.3±0.3V, R <sub>L</sub> =500Ω			0.5		6.2	0.5		8.2	ns
		V <sub>CC</sub> =5±0.5V, R <sub>L</sub> =500Ω			0.5		5.1	0.5		6.5	ns

## Operating Characteristics

PARAMETER	SYMBOL	TEST CONDITIONS	MIN	TYP	MAX	UNIT
Input Capacitance	$C_I$	$V_{CC}=3.3V, V_{IN}=V_{CC}$ or GND		4		pF
Power Dissipation Capacitance	$C_{PD}$	$V_{CC}=1.8V$		22		pF
		$V_{CC}=2.5V$		22		pF
		$V_{CC}=3.3V$		23		pF
		$V_{CC}=5.0V$		25		pF

## Test Circuit And Waveforms

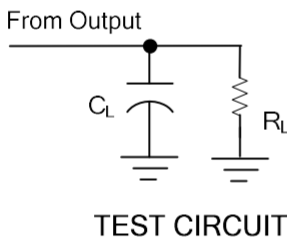

$V_{CC}$	Inputs		$V_M$	$C_L$	$R_L$
	$V_{IN}$	$t_R, t_F$			
$1.8V \pm 0.15V$	$V_{CC}$	$\leq 2ns$	$V_{CC}/2$	15pF	1M $\Omega$
$2.5V \pm 0.2V$	$V_{CC}$	$\leq 2ns$	$V_{CC}/2$	15pF	1M $\Omega$
$3.3V \pm 0.3V$	3V	$\leq 2.5ns$	1.5V	15pF	1M $\Omega$
$5V \pm 0.5V$	$V_{CC}$	$\leq 2.5ns$	$V_{CC}/2$	15pF	1M $\Omega$

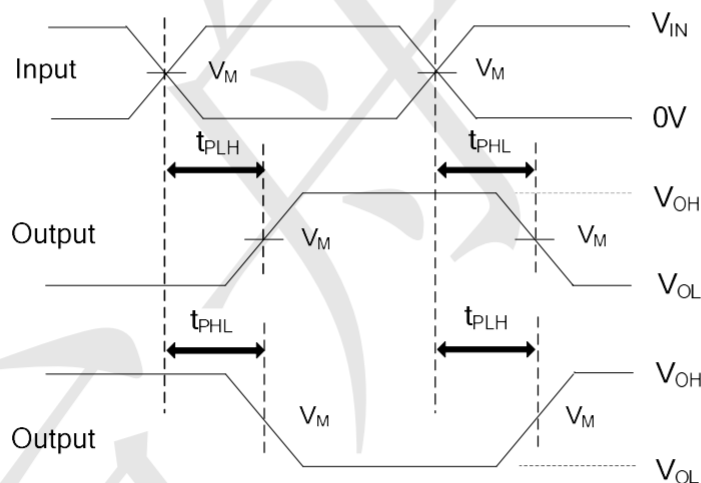

PROPAGATION DELAY TIMES

Note:  $C_L$  includes probe and jig capacitance.

All input pulses are supplied by generators having the following characteristics:  $P_{RR} \leq 10MHz, Z_O = 50\Omega$ .



**Package Outline Dimensions** (Unit: mm)

SOT23-5

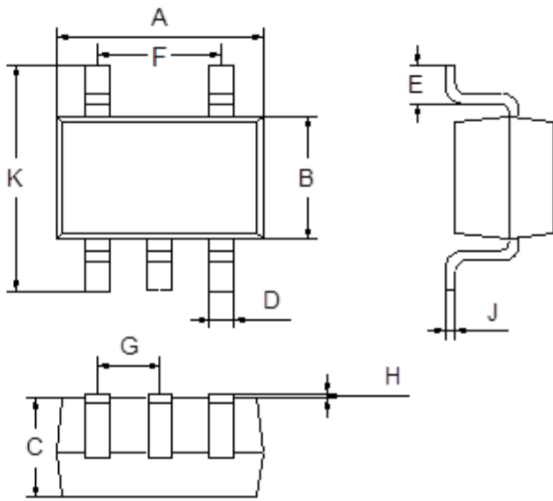

Dimension	Min.	Max.
A	2.80	3.00
B	1.50	1.70
C	1.00	1.20
D	0.35	0.45
E	0.35	0.55
F	1.80	2.00
G	0.90	1.00
H	0.02	0.10
J	0.10	0.20
K	2.60	3.00

**Mounting Pad Layout** (Unit: mm)

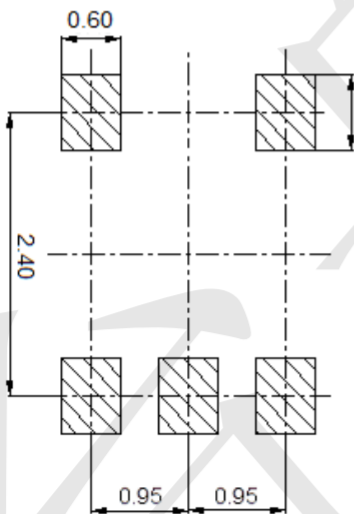



**Package Outline Dimensions** (Unit: mm)

SOT353

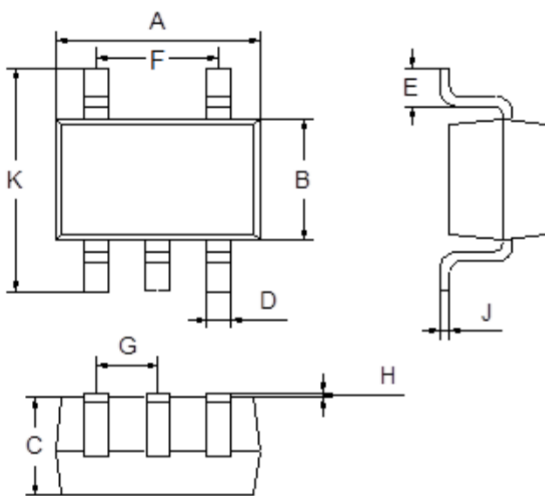

Dimension	Min.	Max.
A	2.00	2.20
B	1.15	1.35
C	0.85	1.05
D	0.15	0.35
E	0.25	0.40
F	1.20	1.40
G	0.60	0.70
H	0.02	0.10
J	0.05	0.15
K	2.20	2.40

**Mounting Pad Layout** (Unit: mm)

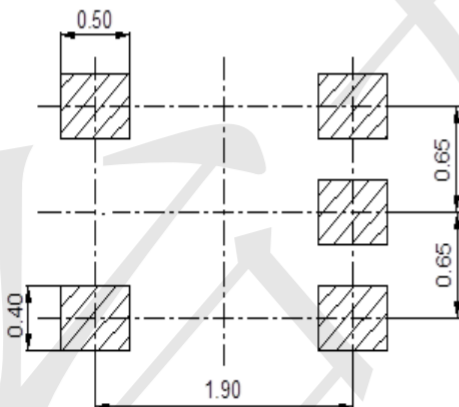



**Package Outline Dimensions** (Unit: mm)

SOT553

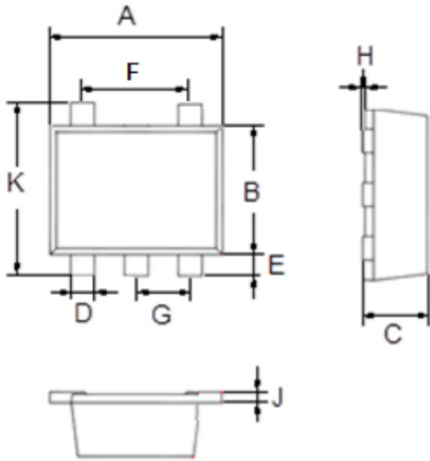

Dimension	Min.	Max.
A	1.500	1.700
B	1.100	1.300
C	0.525	0.600
D	0.170	0.270
E	0.100	0.300
F	0.400	0.600
G	0.450	0.550
H	0.000	0.050
J	0.090	0.160
K	1.500	1.700

**Mounting Pad Layout** (Unit: mm)

