

H2TC4-14+

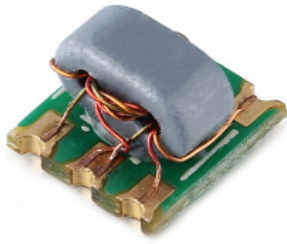

200-1400 MHz

50Ω 1: 4 CT Flux Coupled Transformer

Features

- Operating temperature range: -40°C to +125°C
- Storage temperature range: -55°C to +125°C
- 260°C Reflow Compatible
- RoHS compliant and lead free
- Input Power: 250mW
- DC Current: 30mA

Applications

- For Motorola Walkie-talkie.
- For Car Streaming Media Rearview Mirror.
- For Broadband and Wireless Communications.
- For Wireless Microphone & Marine Communications.
- For Ideally Suited LTE, Cellular, UMTS, WiFi, WiMAX.
- For Differential Modulator/demodulator and Active Mixers.

Electrical Specifications: TA=25°C, 0dBm, Z0=50Ω

Parameter	Test Conditions	Units	Min	Typ	Max
Main line Loss (Pin1-6)	200-1400MHz	dB	—	0.5	1.0
Main line Loss (Pin1-4)	200-1400MHz	dB	—	1.0	1.8
Amplitude Balance	200-1400MHz	dB	—	1.0	1.5
Phase Balance	200-1400MHz	°	—	5.0	10.0
Input Return Loss(Pin1)	200-1400MHz	dB	16.0	18.0	—

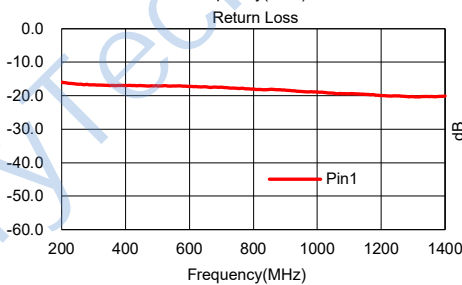
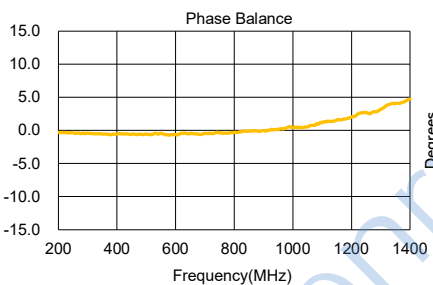
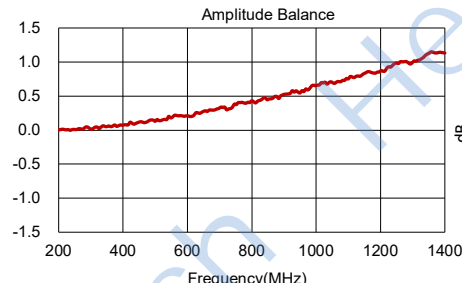
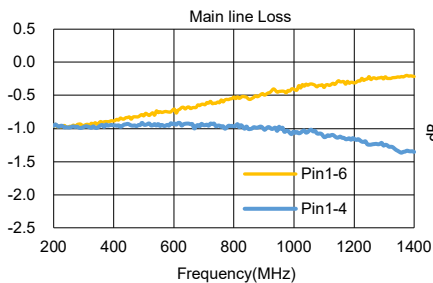

Outline Drawing(mm)

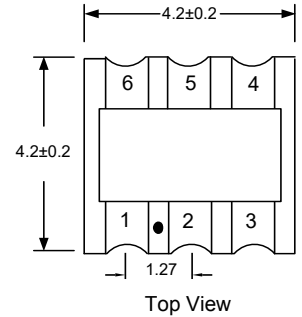

Electrical structure

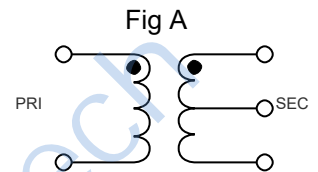

Recommended layout(mm)

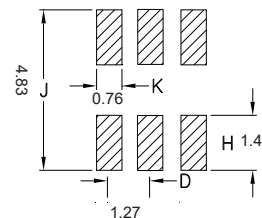

Pin Connections

Input	1
Output 1	6
Output 2	4
Ground	2, 3
NOT USED	5