

### Features

- Fast switching speed
- High conductance
- MSL 1

HF

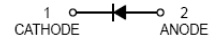

1 CATHODE 2 ANODE

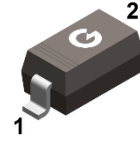

SOD-123

### Mechanical Data

- Case: SOD-123
- Molding Compound: UL Flammability Classification Rating 94V-0
- Terminals: Matte tin-plated leads; solderability-per MIL-STD-202, Method 208

### Ordering Information

Part Number	Package	Shipping Quantity	Marking Code
1N4148W	SOD-123	3000 pcs / Tape & Reel	T4

### Maximum Ratings (@ T<sub>A</sub> = 25°C unless otherwise specified)

Parameter	Symbol	Value	Unit
Non-Repetitive Peak Reverse Voltage	V <sub>RM</sub>	100	V
Peak Repetitive Peak Reverse Voltage	V <sub>RRM</sub>	75	V
Working Peak Reverse Voltage	V <sub>RWM</sub>	75	V
DC Blocking Voltage	V <sub>R</sub>	75	V
RMS Reverse Voltage	V <sub>R(RMS)</sub>	53	V
Average Rectified Output Current	I <sub>F</sub>	200	mA
Peak Forward Surge Current, 1μs Single Half-sine-wave	I <sub>FSM</sub>	2	A
Peak Forward Surge Current, 1s Single Half-sine-wave	I <sub>FSM</sub>	1	A

### Thermal Characteristics

Parameter	Symbol	Value	Unit
Power Dissipation	P <sub>D</sub>	350	mW
Thermal Resistance Junction-to-Air	R <sub>θJA</sub>	357	°C/W
Thermal Resistance Junction-to-Case	R <sub>θJC</sub>	225	°C/W
Operating Junction Temperature Range	T <sub>J</sub>	-65 ~ +150	°C
Storage Temperature Range	T <sub>STG</sub>	-65 ~ +150	°C

**Electrical Characteristics** (@  $T_A = 25^\circ\text{C}$  unless otherwise specified)

Parameter	Symbol	Test Condition	Min.	Typ.	Max.	Unit
Reverse Breakdown Voltage	$V_{(BR)R}$	$I_R = 10\mu\text{A}$	75	-	-	V
Forward Voltage	$V_F$	$I_F = 1\text{mA}$	-	-	0.715	V
		$I_F = 10\text{mA}$	-	-	0.855	V
		$I_F = 50\text{mA}$	-	-	1.000	V
		$I_F = 150\text{mA}$	-	-	1.250	V
Maximum Peak Reverse Current	$I_R$	$V_R = 20\text{V}$	-	-	25	nA
		$V_R = 75\text{V}$	-	-	2.5	$\mu\text{A}$
		$V_R = 25\text{V}, T_J = 125^\circ\text{C}$	-	-	30	$\mu\text{A}$
		$V_R = 75\text{V}, T_J = 150^\circ\text{C}$	-	-	50	$\mu\text{A}$
Total Capacitance	$C_J$	$V_R = 0\text{V}, f = 1.0\text{MHz}$	-	-	2	pF
Reverse Recovery Time	$t_{rr}$	$I_F = I_R = 10\text{mA}$ $I_{rr} = 0.1 \times I_R, R_L = 100\Omega$	-	-	4	ns

Ratings and Characteristics Curves (@  $T_A = 25^\circ\text{C}$  unless otherwise specified)

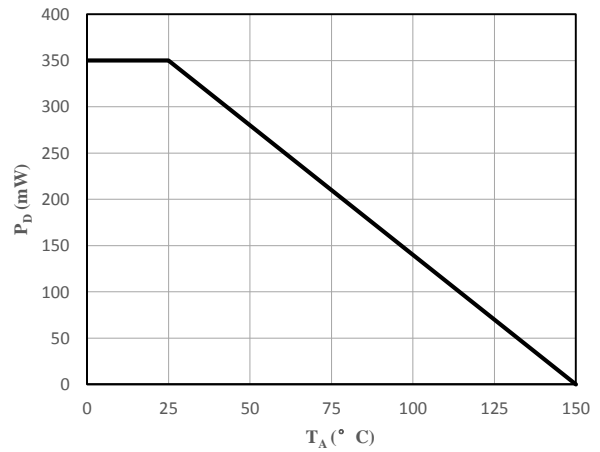
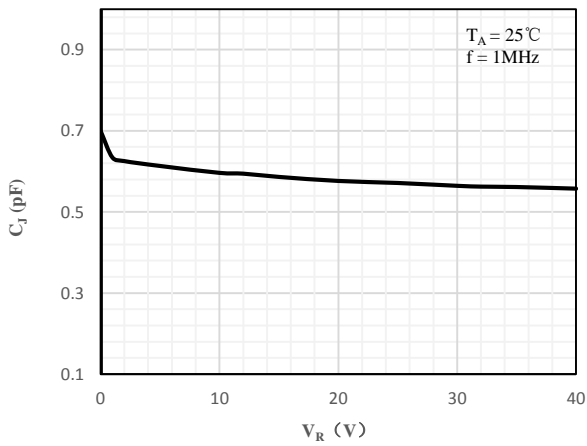
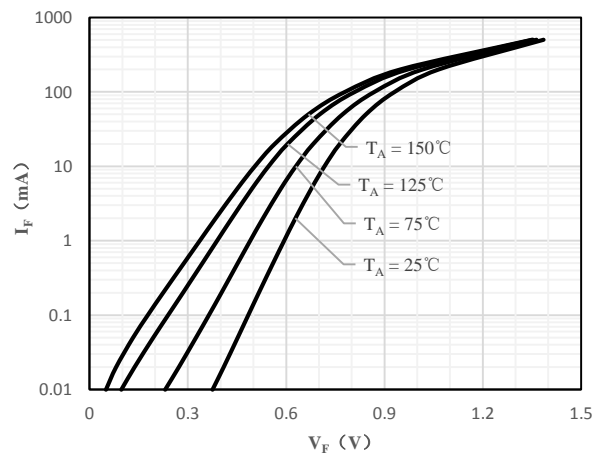
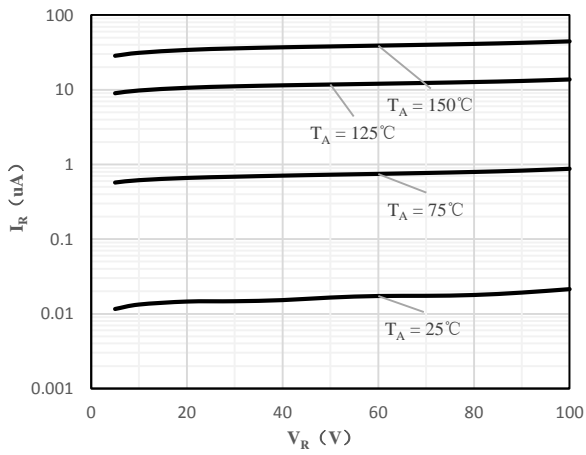

### Package Outline Dimensions (Unit: mm)

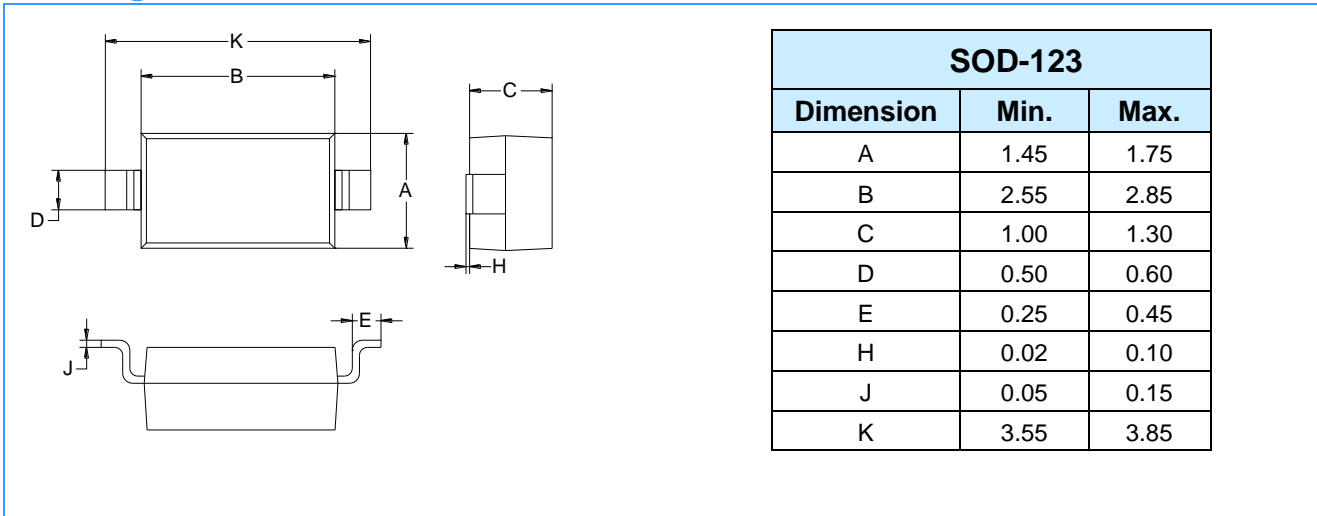

### Package Outline Dimensions (Unit: mm)

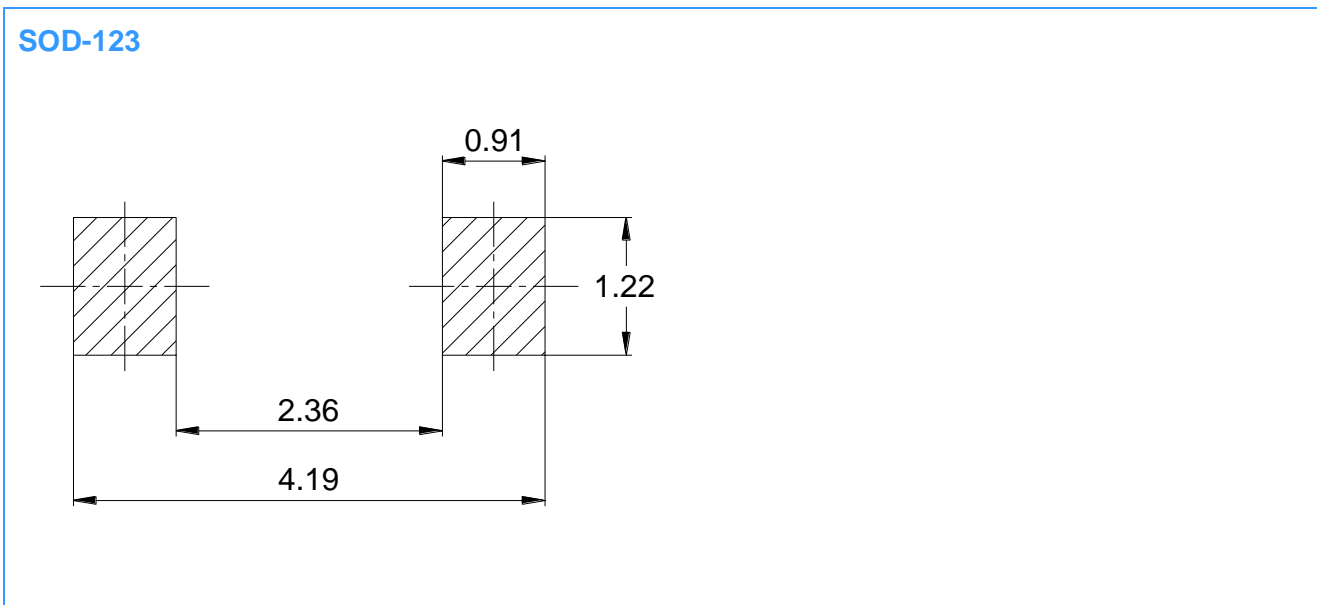

### Important Notice

Changzhou Galaxy Century Microelectronics (GME) reserves the right to make changes without further notice to any product information (copyrighted) herein to make corrections, modifications, improvements, or other changes. GME does not assume any liability arising out of the application or use of any product described herein; neither does it convey any license under its patent rights, nor the rights of others.