

Silicon NPN Epitaxial Type

2SC2383

FEATURES

- High breakdown voltage: $V_{CEO} = 160\text{ V}$
- Large continuous collector current capability
- Recommended for vertical deflection output & sound output applications for line-operated TVs.
- Complementary to 2SA1013

HF

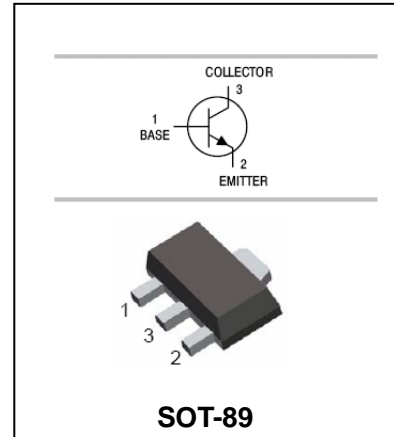

APPLICATIONS

- Color TV Vertical Deflection Output Applications

ORDERING INFORMATION

Type No.	Marking	Package Code
2SC2383	HR2/HO2/HY2	SOT-89

MAXIMUM RATING @ $T_a=25^\circ\text{C}$ unless otherwise specified

Symbol	Parameter	Value	Units
V_{CBO}	Collector-Base Voltage	160	V
V_{CEO}	Collector-Emitter Voltage	160	V
V_{EBO}	Emitter-Base Voltage	6	V
I_C	Collector Current -Continuous	1	A
I_B	Base current	0.5	A
P_C	Collector Dissipation	1	W
T_J	Junction Temperature	150	$^\circ\text{C}$
T_{STG}	Storage Temperature	-55 to +150	$^\circ\text{C}$

Silicon NPN Epitaxial Type

2SC2383

ELECTRICAL CHARACTERISTICS @ Ta=25°C unless otherwise specified

Parameter	Symbol	Test conditions	MIN	TYP	MAX	UNIT
Collector-emitter breakdown voltage	$V_{(BR)CEO}$	$I_C=10mA, I_B=0$	160			V
Collector cut-off current	I_{CBO}	$V_{CB}=150V, I_E=0$			1.0	μA
Emitter cut-off current	I_{EBO}	$V_{EB}=6V, I_C=0$			1.0	μA
DC current gain	h_{FE}	$V_{CE}=5V, I_C=200mA$	60		320	
Collector-emitter saturation voltage	$V_{CE(sat)}$	$I_C=500mA, I_B=50mA$			1.5	V
Base-emitter voltage	V_{BE}	$V_{CE}=5V, I_C=5mA$	0.45		0.75	V
Collector output capacitance	C_{ob}	$V_{CB}=10V, I_E=0, f=1MHz$			20	pF
Transition frequency	f_T	$V_{CE}=5V, I_C=200mA$	20	100		MHz

CLASSIFICATION OF $h_{FE(1)}$

Rank	R	O	Y
Range	60-120	100-200	160-320

Silicon NPN Epitaxial Type

2SC2383

TYPICAL CHARACTERISTICS @ $T_a=25^\circ\text{C}$ unless otherwise specified

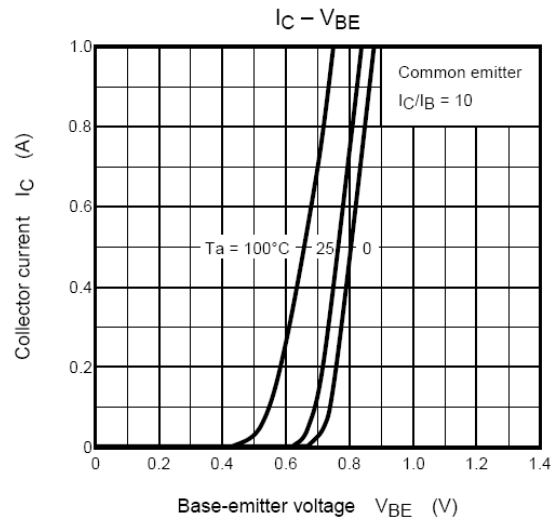
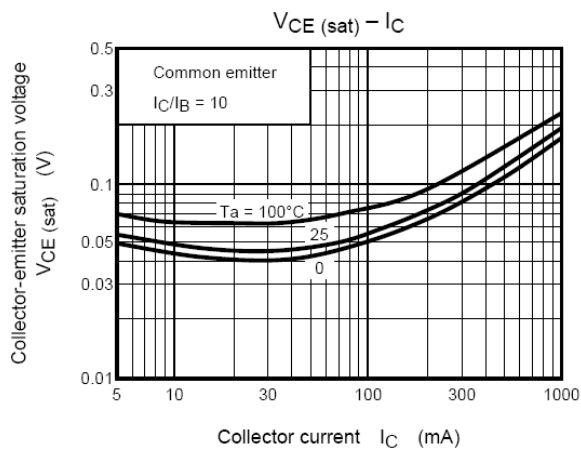
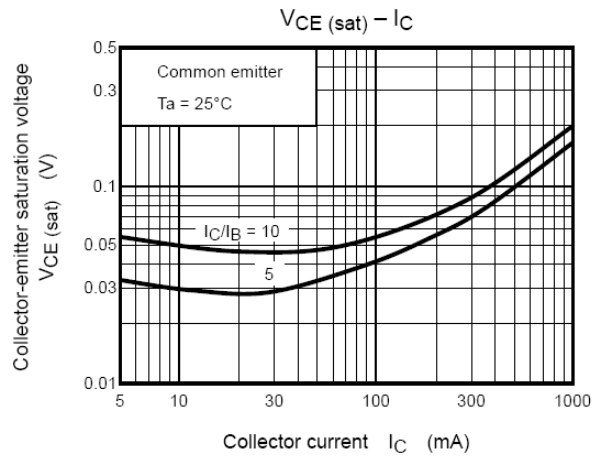
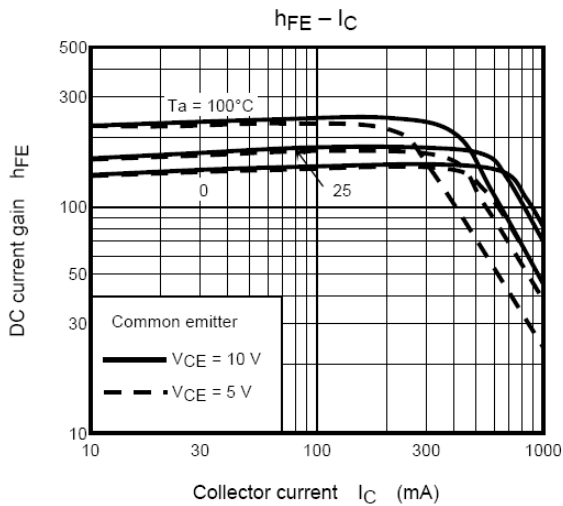
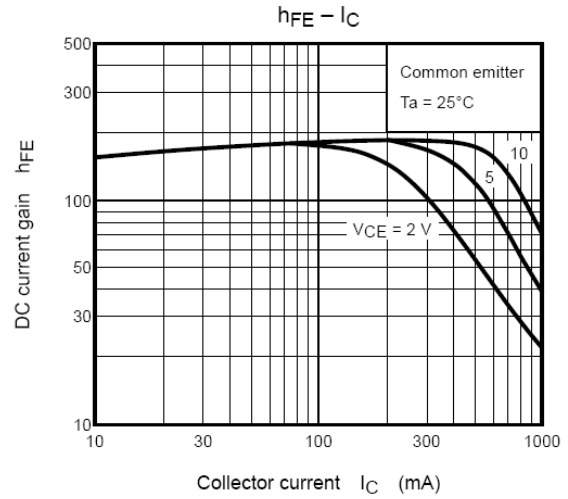
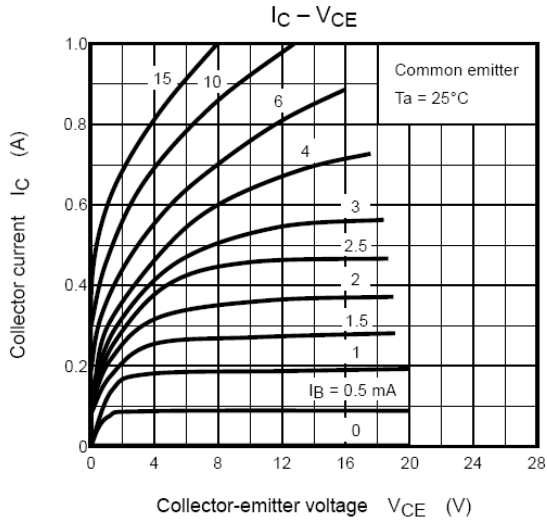

Silicon NPN Epitaxial Type

2SC2383

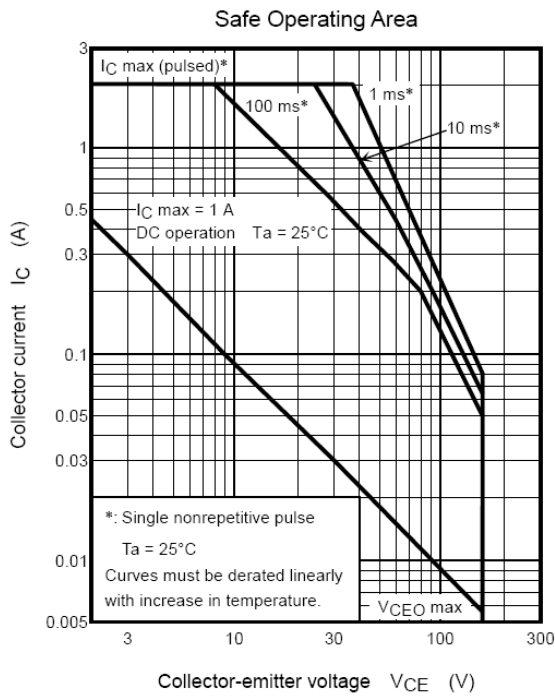
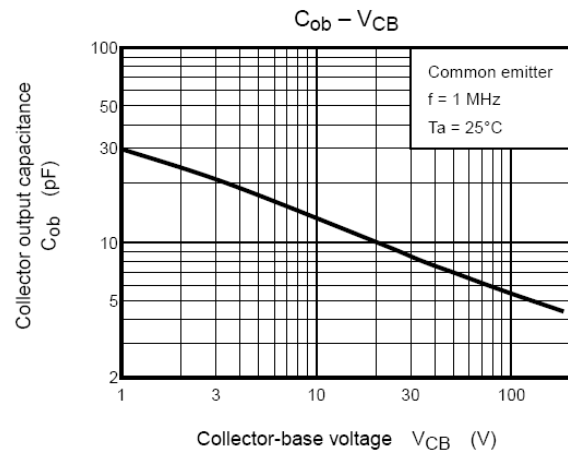
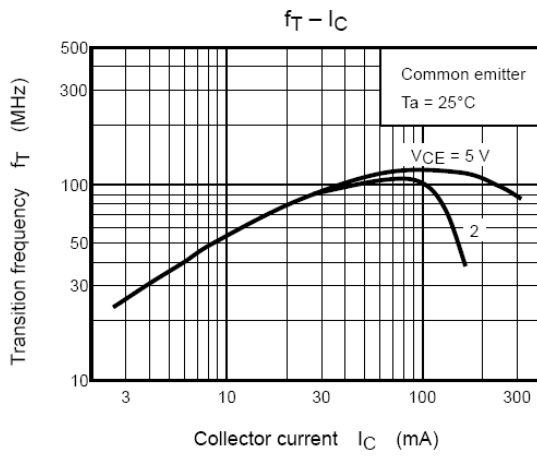

Silicon NPN Epitaxial Type

2SC2383

PACKAGE OUTLINE

Plastic surface mounted package

SOT-89

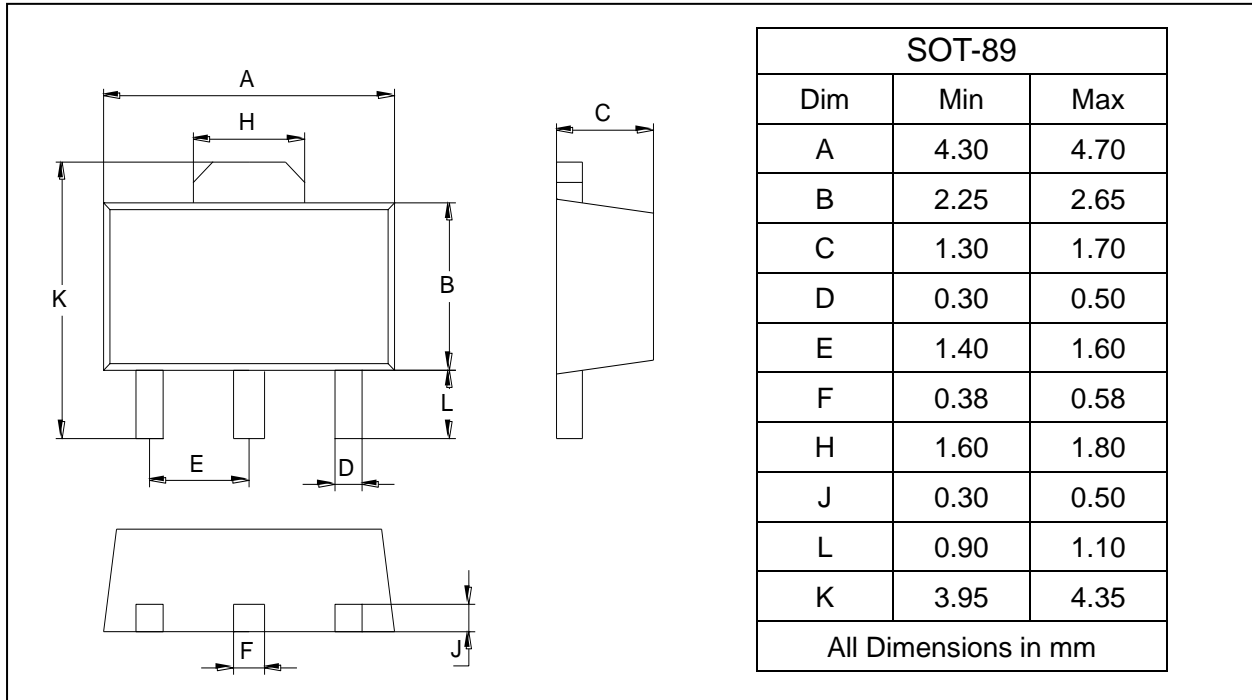

SOLDERING FOOTPRINT

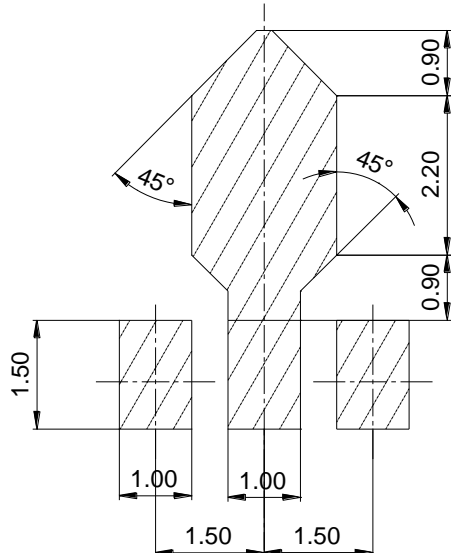

Unit: mm

PACKAGE INFORMATION

Device	Package	Shipping
2SC2383	SOT-89	1000 pcs / Tape & Reel