

# Printed-circuit board connector - DMC 0,5/10-G1-2,54 P20THR R44 - 1844808

Please be informed that the data shown in this PDF Document is generated from our Online Catalog. Please find the complete data in the user's documentation. Our General Terms of Use for Downloads are valid (<http://phoenixcontact.com/download>)

Header, Nominal current: 6 A, Rated voltage (III/2): 160 V, Number of positions: 10, Pitch: 2.54 mm, Color: black, Contact surface: Gold, Mounting: THR soldering, Sample values available under SAMPLE DMC...



The figure shows a 10-pos. version with 20 contacts

## Why buy this product

- Gold-plated contacts ensure transfer quality remains stable over the long term
- Designed for integration into the SMT process
- Conductor connection on several levels enables higher contact density

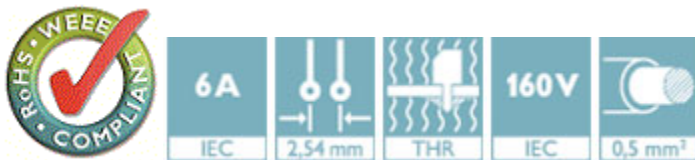

## Key Commercial Data

Packing unit	1 STK
Minimum order quantity	300 STK
Custom tariff number	85366990
Country of origin	Germany

## Technical data

### Environmental Product Compliance

China RoHS	No hazardous substances above threshold values
------------	--

### Dimensions

Length	9.64 mm
Pitch	2.54 mm
Dimension a	22.86 mm
Width	25.9 mm

# Printed-circuit board connector - DMC 0,5/10-G1-2,54 P20THR R44 - 1844808

## Technical data

### Dimensions

Height	7.39 mm
Length of the solder pin	2 mm
Pin dimensions	0,64 x 0,64 mm
Pin spacing	2.54 mm
Hole diameter	1.2 mm

### General

Range of articles	DMC 0,5/...G1-THR
Insulating material group	IIIa
Rated surge voltage (III/3)	2.5 kV
Rated surge voltage (III/2)	2.5 kV
Rated surge voltage (II/2)	2.5 kV
Rated voltage (III/3)	32 V
Rated voltage (III/2)	160 V
Rated voltage (II/2)	160 V
Connection in acc. with standard	EN-VDE
Nominal current $I_N$	6 A
Insulating material	LCP
Flammability rating according to UL 94	V0
Color	black
Number of positions	10

### Standards and Regulations

Connection in acc. with standard	EN-VDE
Flammability rating according to UL 94	V0

### Drawings

# Printed-circuit board connector - DMC 0,5/10-G1-2,54 P20THR R44 - 1844808

Drilling diagram

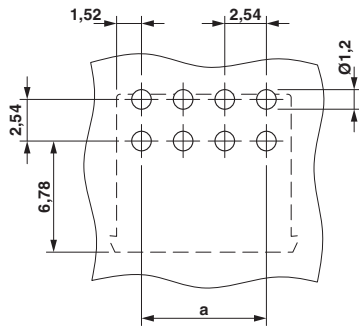

Diagram

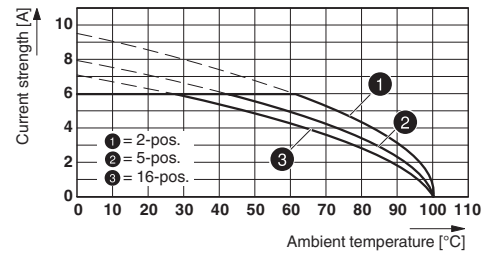

Type: DFMC 0,5/...-ST-2,54 with DMC 0,5/...-G1-2,54 P20THR R...

Dimensional drawing

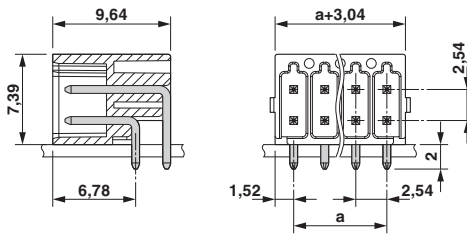

## Classifications

eCl@ss

eCl@ss 5.1	27260701
eCl@ss 6.0	27260704
eCl@ss 8.0	27440402
eCl@ss 9.0	27440402

ETIM

ETIM 4.0	EC002637
ETIM 5.0	EC002637

## Approvals

Approvals

Approvals

cULus Recognized / VDE Gutachten mit Fertigungsüberwachung / IEC60320 CB Scheme / EAC

# Printed-circuit board connector - DMC 0,5/10-G1-2,54 P20THR R44 - 1844808

## Approvals

Ex Approvals

### Approval details

cULus Recognized <a href="http://database.ul.com/cgi-bin/XYV/template/LISEXT/1FRAME/index.htm">http://database.ul.com/cgi-bin/XYV/template/LISEXT/1FRAME/index.htm</a> E60425-19920306		
	B	C
Nominal current IN	6 A	6 A
Nominal voltage UN	150 V	50 V

VDE Gutachten mit Fertigungsüberwachung  <a href="http://www.vde.de">http://www.vde.de</a> 40042389	
Nominal current IN	6 A
Nominal voltage UN	160 V

IECEE CB Scheme  <a href="http://www.iecee.org/">http://www.iecee.org/</a> DE1-55740	
Nominal current IN	6 A
Nominal voltage UN	160 V

EAC B.01742
-------------

## Accessories

### Accessories

#### Labeled terminal marker

Marker card - SK 2,54/2,8:FORTL.ZAHLEN - 0804853



Marker card, Card, white, labeled, Horizontal: Consecutive numbers 1 - 10, 11 - 20, etc. up to 91 - 99, Mounting type: Adhesive, for terminal block width: 2.54 mm, Lettering field: 2.54 x 2.8 mm

## Printed-circuit board connector - DMC 0,5/10-G1-2,54 P20THR R44 - 1844808

### Accessories

Sample set - SAMPLE DMC 0,5/10-G1-2,54 THR - 1859576



Header, Nominal current: 6 A, Rated voltage (III/2): 160 V, Number of positions: 10, Pitch: 2.54 mm, Color: black, Contact surface: Gold, Mounting: THR soldering

---

### Additional products

Printed-circuit board connector - DFMC 0,5/10-ST-2,54 - 1844659



Plug, nominal current: 6 A, rated voltage (III/2): 160 V, number of positions: 10 with 20 contacts, pitch: 2.54 mm, connection method: spring connection, color: black, contact surface: gold