

**HSF** RoHS

**SPECIFICATIONS**

Rated(额定参数): 300V,8A  
 Dielectric strength(抗电强度): AC1500V/1 Minute  
 Insulation Resistance(绝缘电阻):1000MΩ Min  
 Contact Resistance(接触电阻):20mΩ Max  
 Screw Torque(扭矩): 0.2Nm (1.7Lb.in)  
 Wire Range(线径):16~28AWG  
 Strip length(剥线长度):6~7mm  
 Temp. range(操作温度): -40℃~+105℃  
 MAX Soldering(瞬时温度):+260℃,5s

IEC Standard

Pollution degree	2	2	3
Overvoltage category	II	III	III
Rate impulse voltage(KV)	2.5KV	2.5KV	2.5KV
Rate voltage(V)	320V	250V	160V
Rate current(A)	8A		

Housing Material(塑件): PA66 (UL94 V-0)  
 Contact(端子): Phosphor Bronze, Tin plating(磷铜镀镍)  
 Clamp(方块): Brass(黄铜), Ni plating(镀镍)  
 Screw (螺丝): M2.0 Steel, Zinc plating(钢,镀锌)

PITCH RANGE IN MM			NOMINAL DIMENSION RANGE IN MM				
TO	OVER	OVER	TO	OVER	OVER	OVER	OVER
6	6	10	30	30	60	100	150
10	10	24	60	60	100	150	150
±0.10	±0.15	±0.25	±0.30	±0.30	±0.50	±0.70	±1.00

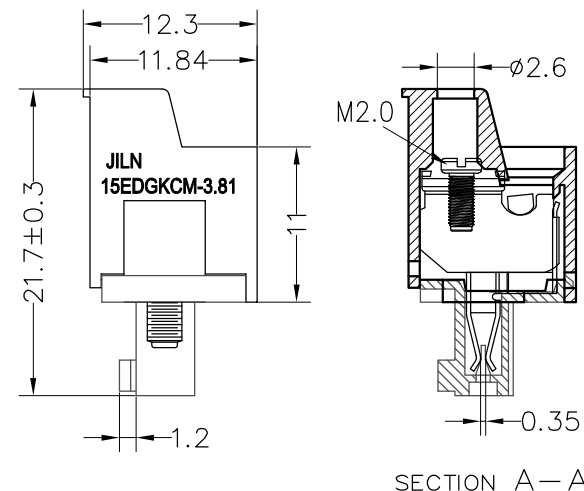
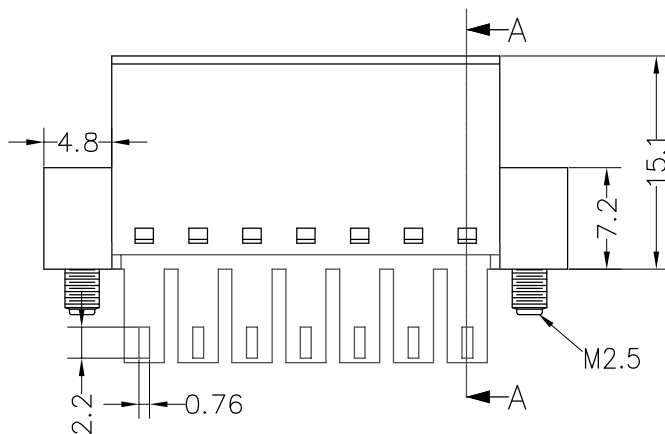
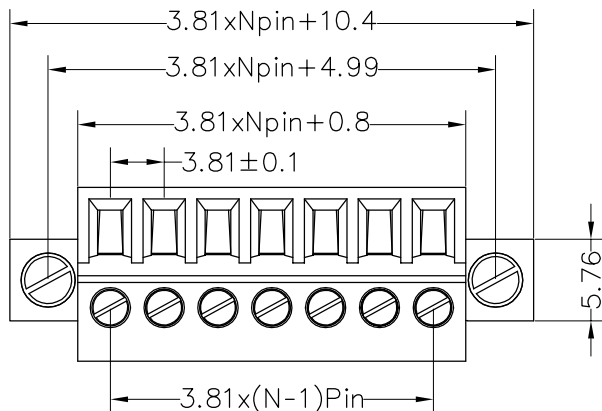

**Ordering Information**

**JL15EDGKCM - 381 XX G 0 1**

Pitch  
381=3.81PH

No. of pins  
2P,3P,4P~24P

Housing Color  
B=Black  
G=Green  
U=Blue  
R=Red  
W=White  
Y=Yellow  
O=Orange  
E=Grey

Packing  
0=Pe bag  
T=Tube  
A=Tray

DRAW	SHUANGPING ZHENG	SCALE	FIT
CHECK	LICHAO LIU	UNIT	mm
APPROVE	YONGLIANG GAO	SIZE	A4
		SHEET	1/1
		PROJ.	

**JILN** 东莞市锦凌电子有限公司  
 DONGGUAN JINLING ELECTRONIC CO.,LTD

PART NO. JL15EDGKCM-381XXG01

TITLE: JL15EDGKCM-3.81-XXP插拔式母座/PA66/绿色/带耳