



General Description

The AOD66923 use advanced SGT MOSFET technology to provide low RDS(ON), low gate charge, fast switching and excellent avalanche characteristics.

This device is specially designed to get better ruggedness and suitable to use in



TO-252-2L

General Features

$V_{DS} = 100V$ $I_D = 70A$

$R_{DS(ON)} < 17m\Omega$ @ $V_{GS} = 10V$

Applications

Consumer electronic power supply Motor control

Synchronous-rectification Isolated DC

Synchronous-rectification applications

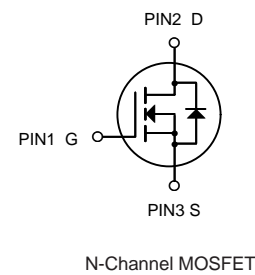

Package Marking and Ordering Information

Product ID	Pack	Brand	Qty(PCS)
AOD66923	TO-252-2L	HXY MOSFET	2500

Absolute Maximum Ratings at $T_j = 25^\circ C$ unless otherwise noted

Parameter	Symbol	Value	Unit
Drain source voltage	VDS	100	V
Gate source voltage	VGS	± 20	V
Continuous drain current ¹⁾	ID	70	A
Pulsed drain current ²⁾	ID, pulse	280	A
Power dissipation ³⁾	P _D	100	W
Single pulsed avalanche energy ⁵⁾	EAS	110	mJ
Operation and storage temperature	Tstg, Tj	-55 to 150	°C
Thermal resistance, junction-case	R θ JC	1.25	°C/W
Thermal Resistance Junction-Ambient ¹	R θ JA	64	°C/W



Electrical Characteristics ($T_J = 25^\circ\text{C}$, unless otherwise noted)

Symbol	Parameter	Test Conditions	Value			Units
			Min.	Typ.	Max.	
V_{DSS}	Drain to Source Breakdown Voltage	$V_{GS}=0V, I_D=250\mu A$	100	--	--	V
I_{DSS}	Drain to Source Leakage Current	$V_{DS}=100V, V_{GS}=0V$	--	--	1	μA
$I_{GSS(F)}$	Gate to Source Forward Leakage	$V_{GS}=+20V, V_{DS}=0V$	--	--	100	nA
$I_{GSS(R)}$	Gate to Source Reverse Leakage	$V_{GS}=-20V, V_{DS}=0V$	--	--	-100	nA
$V_{GS(TH)}$	Gate Threshold Voltage	$V_{DS}=V_{GS}, I_D=250\mu A$	1.3	1.8	2.3	V
$R_{DS(ON)}$	Drain-to-Source On-Resistance	$V_{GS}=10V, I_D=20A$	--	8.5	10.5	$m\Omega$
		$V_{GS}=4.5V, I_D=15A$		9.5	15	$m\Omega$
C_{iss}	Input Capacitance	$V_{GS} = 0V$ $V_{DS} = 50V$ $f = 1.0MHz$	--	1368	--	pF
C_{oss}	Output Capacitance		--	451	--	
C_{rss}	Reverse Transfer Capacitance		--	12.9	--	
R_g	Gate resistance	$V_{GS}=0V, V_{DS}$ Open	--	0.48	--	Ω
$t_{d(ON)}$	Turn-on Delay Time	$I_D = 10A$ $V_{DS} = 50V$ $V_{GS} = 10V$ $R_G = 4\Omega$	--	16	--	ns
t_r	Rise Time		--	10	--	
$t_{d(OFF)}$	Turn-Off Delay Time		--	40	--	
t_f	Fall Time		--	6	--	
Q_g	Total Gate Charge	$V_{GS} = 10V$	--	31.3	--	nC
Q_{gs}	Gate Source Charge	$V_{DS} = 50V$	--	3.49	--	
Q_{gd}	Gate Drain Charge	$I_D = 10A$	--	7.63	--	
I_S	Diode Forward Current	$T_C = 25^\circ C$	--	--	70	A
V_{SD}	Diode Forward Voltage	$I_S=10A, V_{GS}=0V$	--	--	1.2	V
t_{rr}	Reverse Recovery time	$I_S=10A, V_{DD}=50V$	--	103	--	ns
Q_{rr}	Reverse Recovery Charge	$dI/dt=100A/\mu s$	--	187	--	nC

a1: Repetitive rating; pulse width limited by maximum junction temperature

a2: $V_{DD}=50V, L=0.3mH, R_g=25\Omega, \text{Starting } T_J=25^\circ C$



Typical Characteristics

Typ. output characteristics
 $I_D=f(V_{DS})$

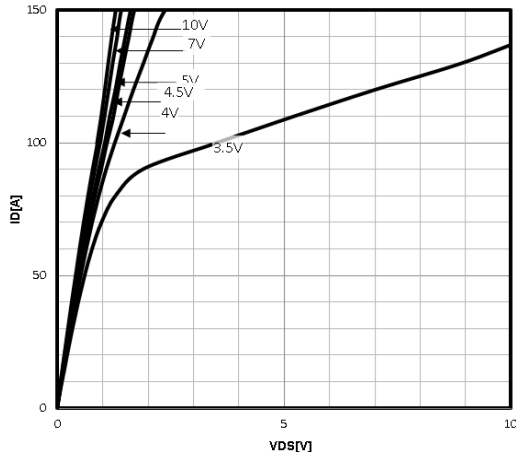

Typ. drain-source on resistance
 $R_{DS(on)}=f(I_D)$

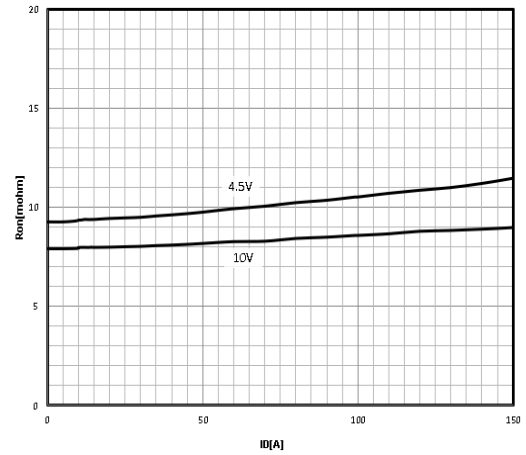

Typ. transfer characteristics
 $I_D=f(V_{GS})$

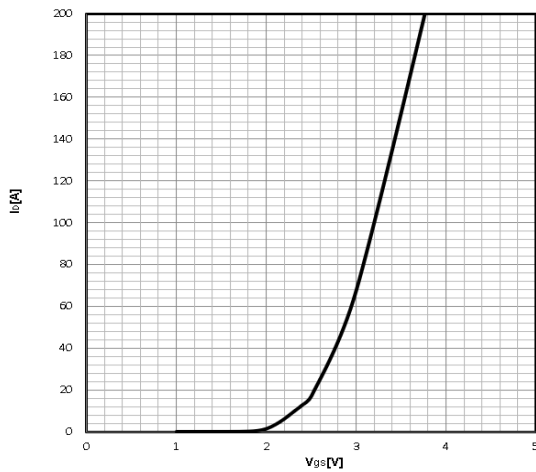

Drain-source on-state resistance
 $R_{DS(on)}=f(T_j); I_D=20A; V_{GS}=10V$

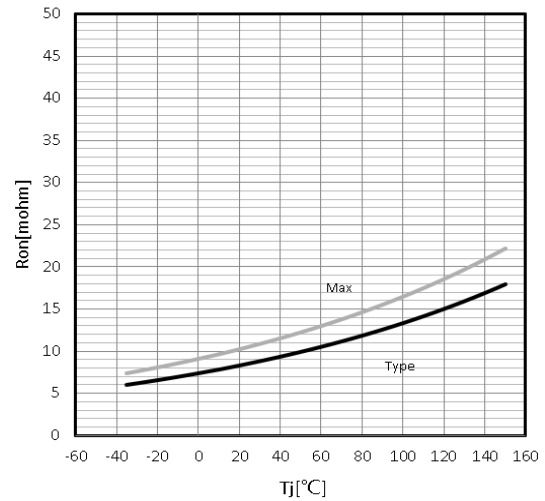

Gate Threshold Voltage
 $V_{TH}=f(T_j); I_D=250\mu A$

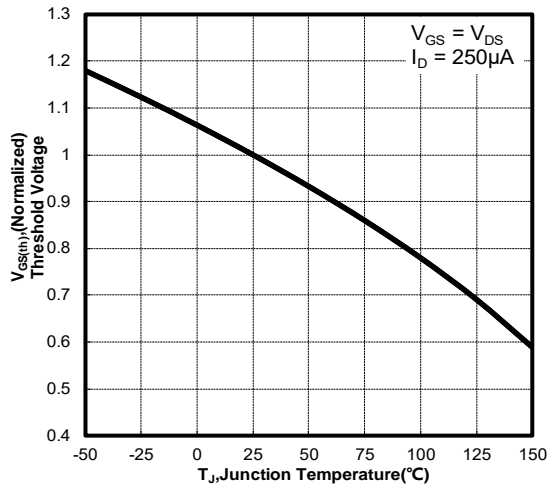

Drain-source breakdown voltage
 $V_{BR(DSS)}=f(T_j); I_D=250\mu A$

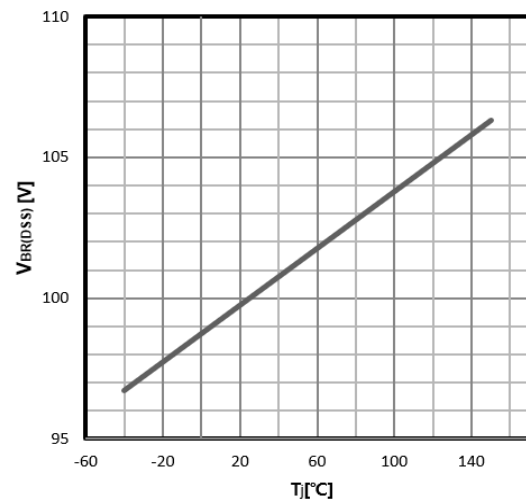



Typ. gate charge
 $V_{GS}=f(Q_g)$; $I_D=10A$

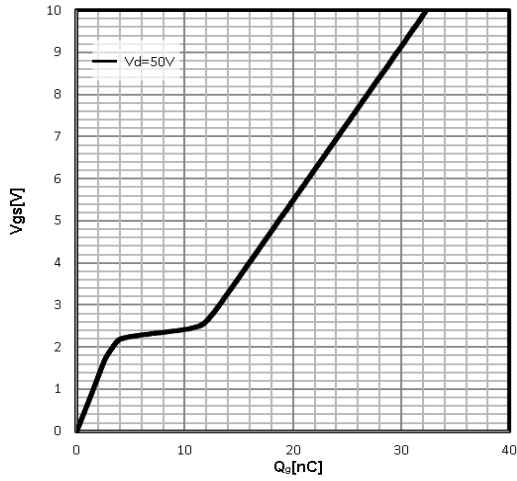

Typ. capacitances
 $C=f(V_{DS})$; $V_{GS}=0V$; $f=1MHz$

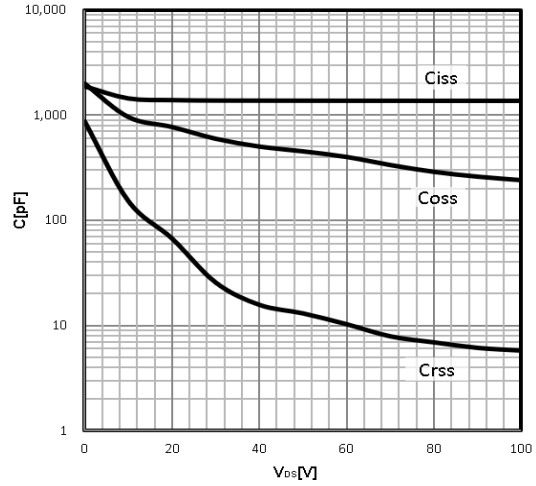

Power Dissipation
 $P_{tot}=f(T_c)$

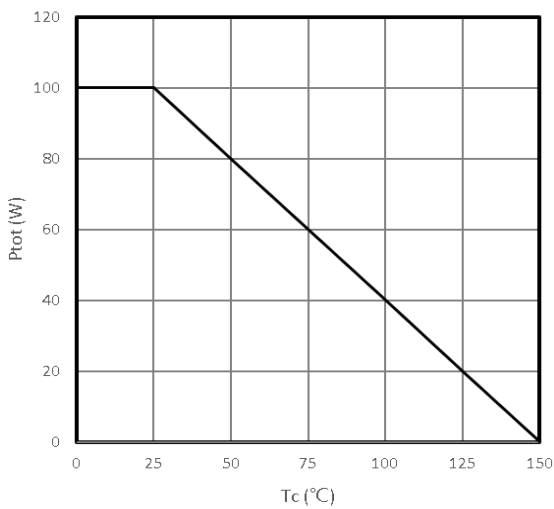

Maximum Drain Current
 $I_D=f(T_c)$

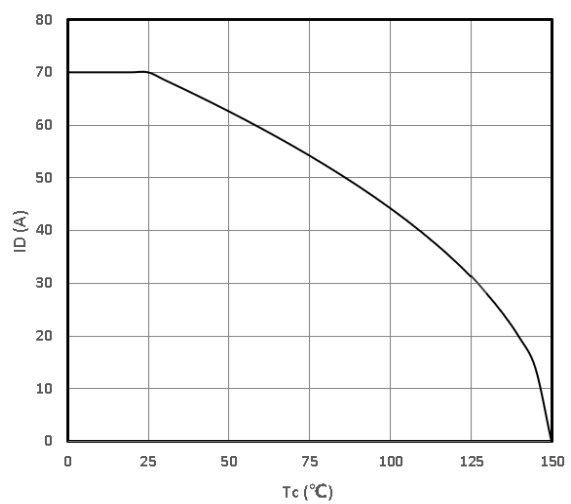

Safe operating area
 $I_D=f(V_{DS})$

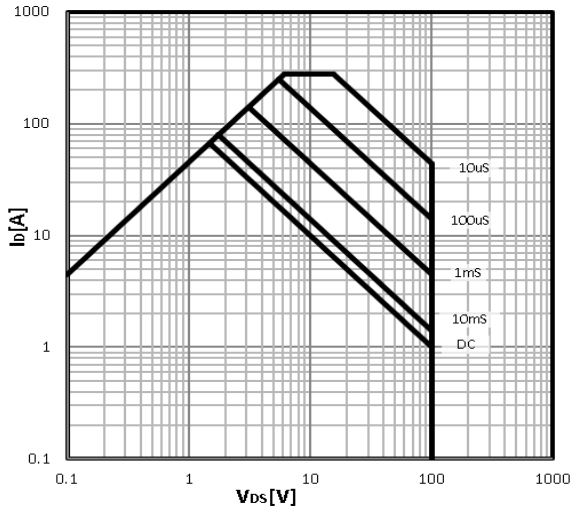

Body Diode Forward Voltage Variation
 $I_F=f(V_{GS})$

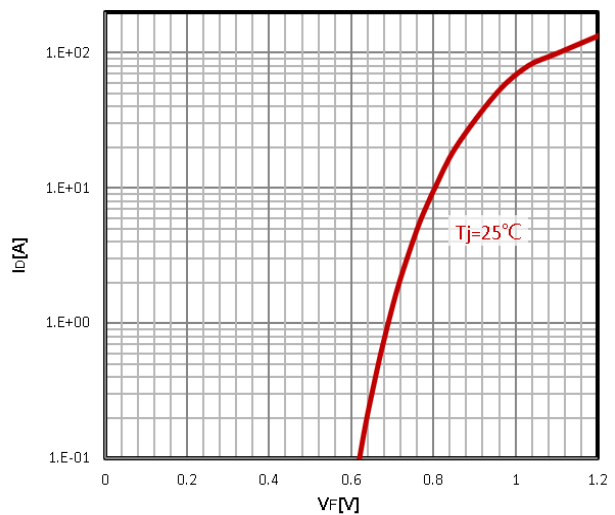



Max. transient thermal impedance

$$Z_{thJC} = f(t_p)$$

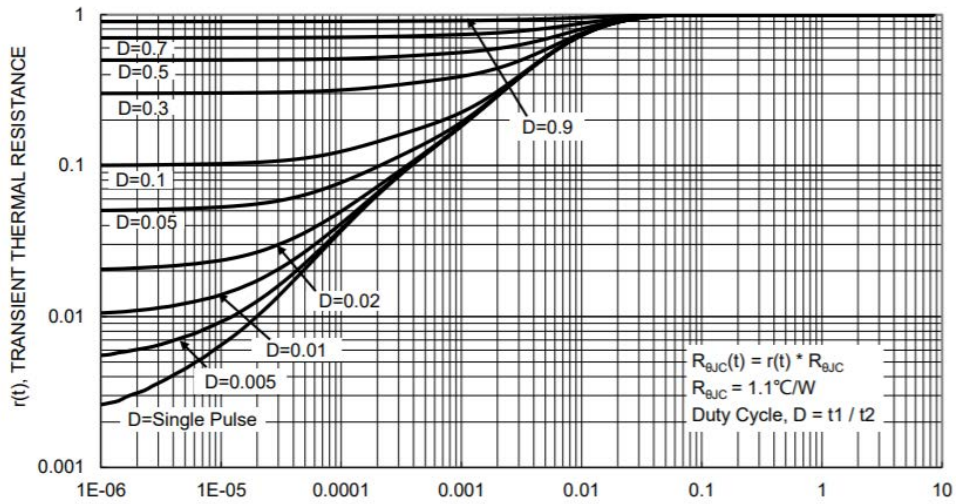



Test Circuit and Waveform:

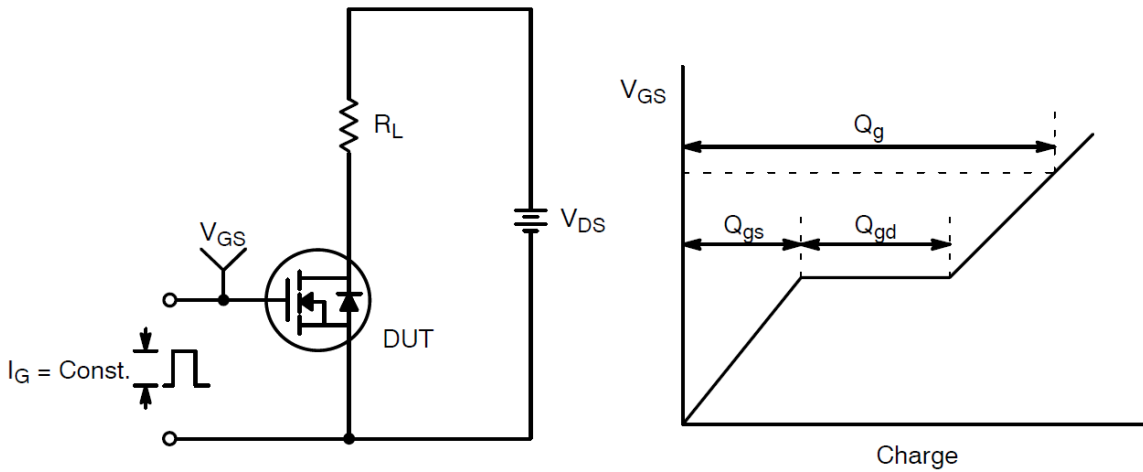

Gate Charge Test Circuit & Waveform

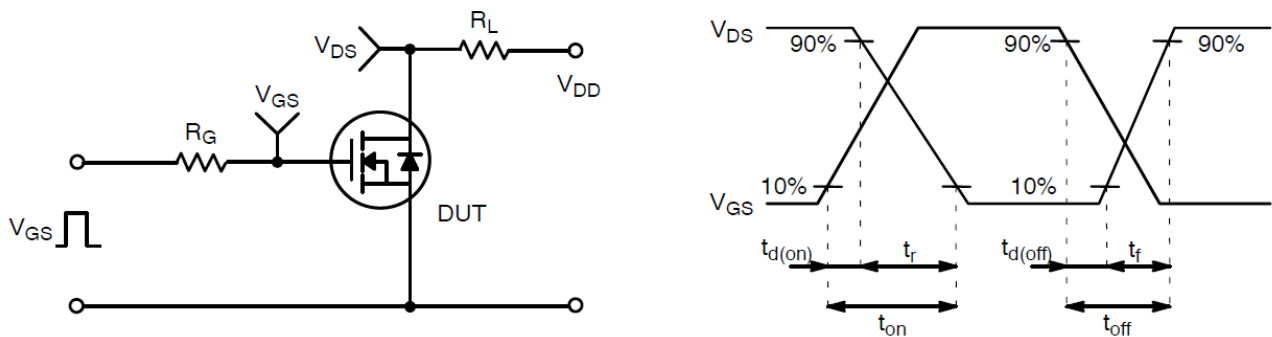

Resistive Switching Test Circuit & Waveforms

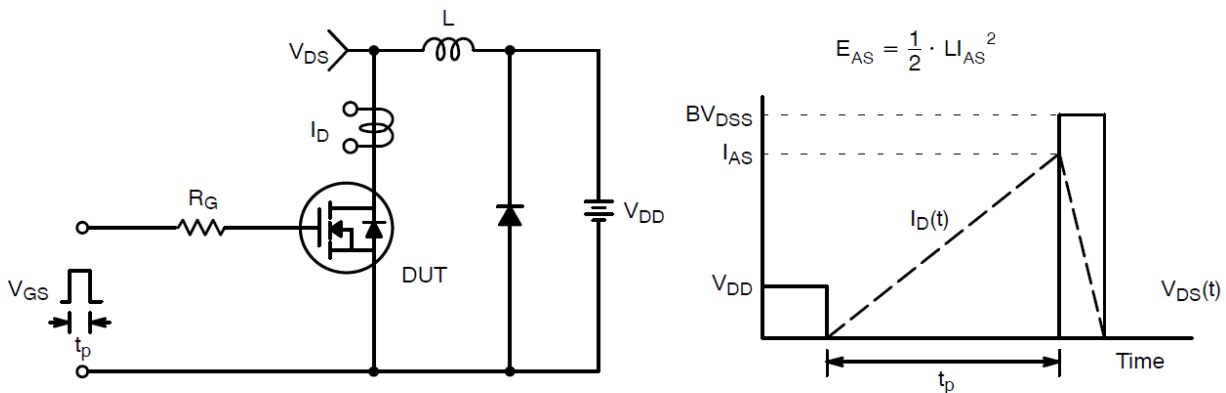

Unclamped Inductive Switching Test Circuit & Waveforms



TO-252-2L Package Information

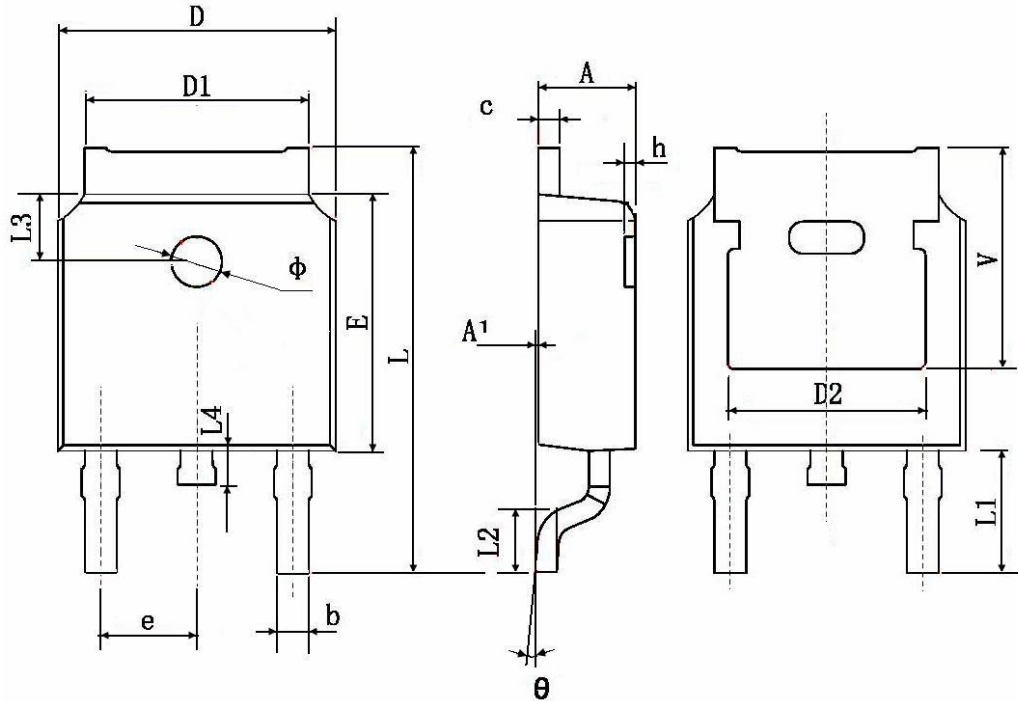

Symbol	Dimensions In Millimeters		Dimensions In Inches	
	Min.	Max.	Min.	Max.
A	2.200	2.400	0.087	0.094
A1	0.000	0.127	0.000	0.005
b	0.660	0.860	0.026	0.034
c	0.460	0.580	0.018	0.023
D	6.500	6.700	0.256	0.264
D1	5.100	5.460	0.201	0.215
D2	0.483 TYP.		0.190 TYP.	
E	6.000	6.200	0.236	0.244
e	2.186	2.386	0.086	0.094
L	9.800	10.400	0.386	0.409
L1	2.900 TYP.		0.114 TYP.	
L2	1.400	1.700	0.055	0.067
L3	1.600 TYP.		0.063 TYP.	
L4	0.600	1.000	0.024	0.039
phi	1.100	1.300	0.043	0.051
theta	0°	8°	0°	8°
h	0.000	0.300	0.000	0.012
V	5.350 TYP.		0.211 TYP.	



Attention

- Any and all HUA XUAN YANG ELECTRONICS products described or contained herein do not have specifications that can handle applications that require extremely high levels of reliability, such as life-support systems, aircraft's control systems, or other applications whose failure can be reasonably expected to result in serious physical and/or material damage. Consult with your HUA XUAN YANG ELECTRONICS representative nearest you before using any HUA XUAN YANG ELECTRONICS products described or contained herein in such applications.
- HUA XUAN YANG ELECTRONICS assumes no responsibility for equipment failures that result from using products at values that exceed, even momentarily, rated values (such as maximum ratings, operating condition ranges, or other parameters) listed in products specifications of any and all HUA XUAN YANG ELECTRONICS products described or contained herein.
- Specifications of any and all HUA XUAN YANG ELECTRONICS products described or contained herein stipulate the performance, characteristics, and functions of the described products in the independent state, and are not guarantees of the performance, characteristics, and functions of the described products as mounted in the customer's products or equipment. To verify symptoms and states that cannot be evaluated in an independent device, the customer should always evaluate and test devices mounted in the customer's products or equipment.
- HUA XUAN YANG ELECTRONICS CO.,LTD. strives to supply high-quality high-reliability products. However, any and all semiconductor products fail with some probability. It is possible that these probabilistic failures could give rise to accidents or events that could endanger human lives, that could give rise to smoke or fire, or that could cause damage to other property. When designing equipment, adopt safety measures so that these kinds of accidents or events cannot occur. Such measures include but are not limited to protective circuits and error prevention circuits for safe design, redundant design, and structural design.
- In the event that any or all HUA XUAN YANG ELECTRONICS products(including technical data, services) described or contained herein are controlled under any of applicable local export control laws and regulations, such products must not be exported without obtaining the export license from the authorities concerned in accordance with the above law.
- No part of this publication may be reproduced or transmitted in any form or by any means, electronic or mechanical, including photocopying and recording, or any information storage or retrieval system, or otherwise, without the prior written permission of HUA XUAN YANG ELECTRONICS CO.,LTD.
- Information (including circuit diagrams and circuit parameters) herein is for example only ; it is not guaranteed for volume production. HUA XUAN YANG ELECTRONICS believes information herein is accurate and reliable, but no guarantees are made or implied regarding its use or any infringements of intellectual property rights or other rights of third parties.
- Any and all information described or contained herein are subject to change without notice due to product/technology improvement, etc. When designing equipment, refer to the "Delivery Specification" for the HUA XUAN YANG ELECTRONICS product that you intend to use.