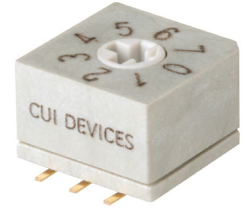

SERIES: RDS6-1065-SMT | **DESCRIPTION:** ROTARY DIP SWITCH

FEATURES

- 4, 8, 10 & 16 position
- removable cap options
- cross actuated

SPECIFICATIONS

parameter	conditions/description	min	typ	max	units
rated voltage	switching			42	Vdc
	non-switching			42	Vdc
rated current	switching			150	mA
	non-switching			200	mA
withstanding voltage	for 1 minute		250		Vac
contact resistance				80	mΩ
insulation resistance	for 1 minute at 250 Vdc	100			MΩ
operating torque				700	gf*cm
actuator travel	continuous rotation		360		degrees
operating temperature		-40		85	°C
storage temperature		-40		85	°C
life	at 42 Vdc, 150 mA, 15~20 cycles/minute		10,000		steps
flammability rating	see material tables				
RoHS	yes				

PART NUMBER KEY
RDS6 - XXS - 1065 - X - SMT - TR

Base Number

 No. of Positions:
 4 = 4 Positions
 8 = 8 Positions
 10 = 10 Positions
 16 = 16 Positions

 Actuator Cap:
 "blank" = Without Cap
 1 = Notched Cap
 2 = Raised Slotted Cap
 3 = Numbered Dial

MECHANICAL DRAWING (4 POSITION)

units: mm
 tolerance: ±0.3 mm
 unless otherwise specified

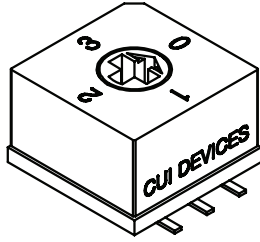

DESCRIPTION	MATERIAL	PLATING/COLOR
actuator	PA66 (UL94V-0)	white
cover	LCP (UL94V-0)	gray
base	LCP (UL94V-0)	gray
terminals	phosphorus bronze	Ni/Au

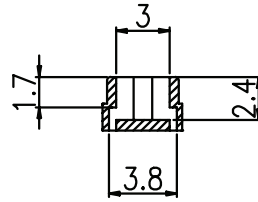
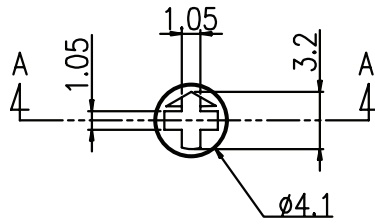
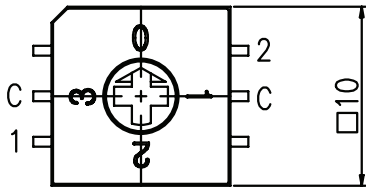

Section A-A'

ACTUATOR

TYPE	POS	CODE		
		C	1	2
4 POSITION	0	●	○	○
	1	●	●	○
	2	●	○	●
	3	●	●	●

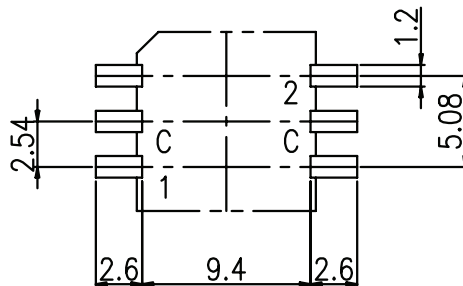
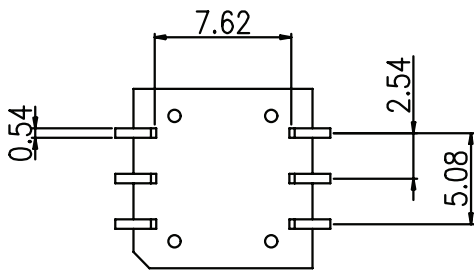
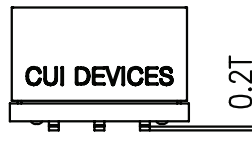
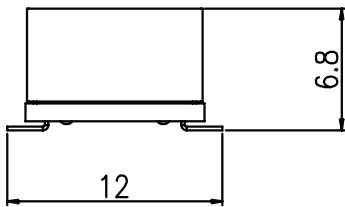

Recommended PCB Layout
 Top View

MECHANICAL DRAWING (8 POSITION)

units: mm
 tolerance: ±0.3 mm
 unless otherwise specified

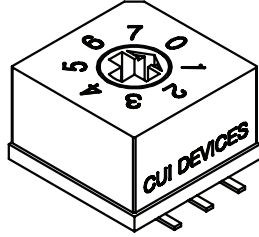

DESCRIPTION	MATERIAL	PLATING/COLOR
actuator	PA66 [UL94V-0]	white
cover	LCP [UL94V-0]	gray
base	LCP [UL94V-0]	gray
terminals	phosphorus bronze	Ni/Au

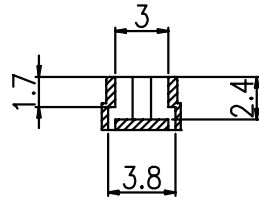
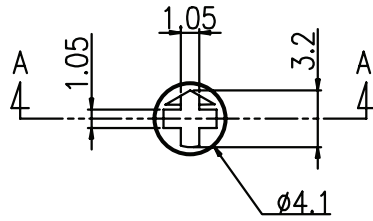
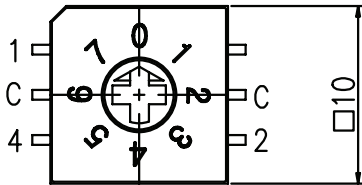

Section A-A'

ACTUATOR

ON ●					
OFF ○	CODE				
TYPE	POS	C	1	2	4
8 POSITION	0	●	○	○	○
	1	●	●	○	○
	2	●	○	●	○
	3	●	●	●	○
	4	●	○	○	●
	5	●	●	○	●
	6	●	○	●	●
	7	●	●	●	●

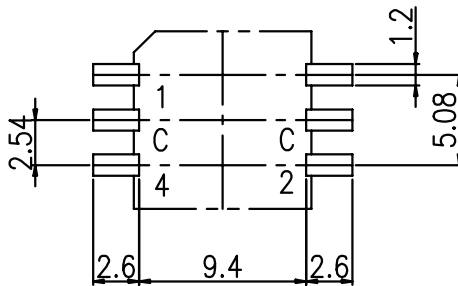
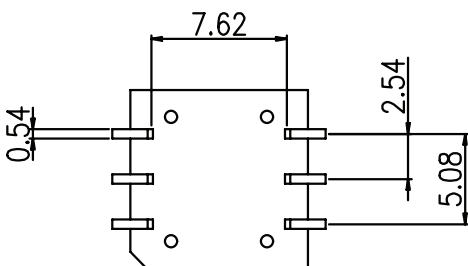
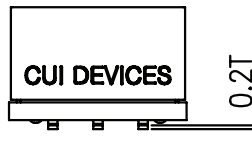
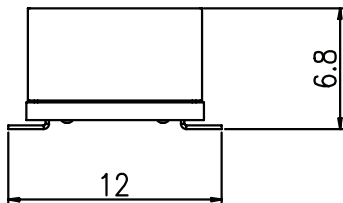

Recommended PCB Layout
 Top View

MECHANICAL DRAWING (10 POSITION)

units: mm
tolerance: ±0.3 mm
unless otherwise specified

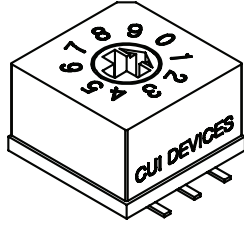

DESCRIPTION	MATERIAL	PLATING/COLOR
actuator	PA66 (UL94V-0)	white
cover	LCP (UL94V-0)	gray
base	LCP (UL94V-0)	gray
terminals	phosphorus bronze	Ni/Au

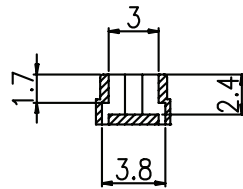
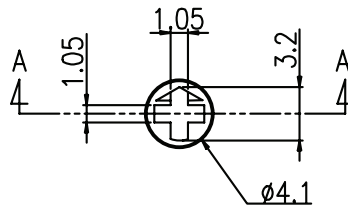
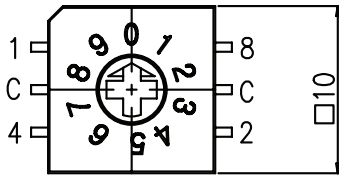

Section A-A'

ACTUATOR

TYPE	POS	CODE				
		C	1	2	4	8
10 POSITION	0	●	○	○	○	○
	1	●	●	○	○	○
	2	●	○	●	○	○
	3	●	●	●	○	○
	4	●	○	○	●	○
	5	●	●	○	●	○
	6	●	○	●	●	○
	7	●	●	●	●	○
	8	●	○	○	○	●
	9	●	●	○	○	●

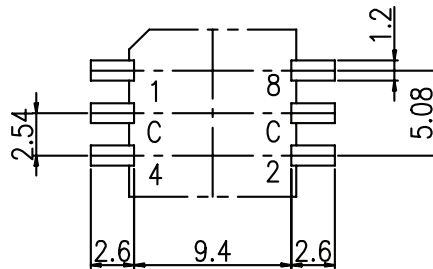
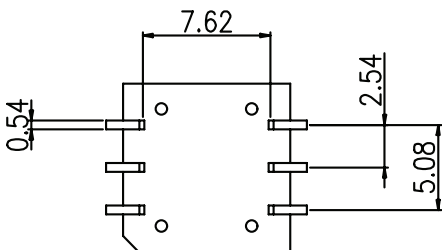
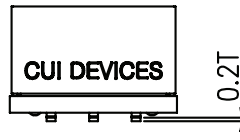
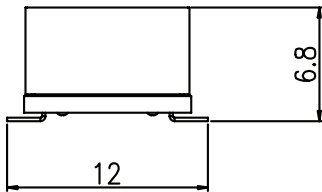

Recommended PCB Layout
Top View

MECHANICAL DRAWING (16 POSITION)

units: mm
 tolerance: ±0.3 mm
 unless otherwise specified

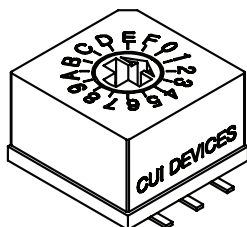

DESCRIPTION	MATERIAL	PLATING/COLOR
actuator	PA66 (UL94V-0)	white
cover	LCP (UL94V-0)	gray
base	LCP (UL94V-0)	gray
terminals	phosphorus bronze	Ni/Au

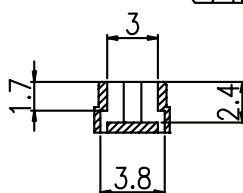
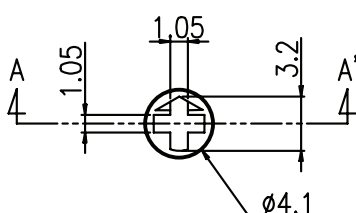
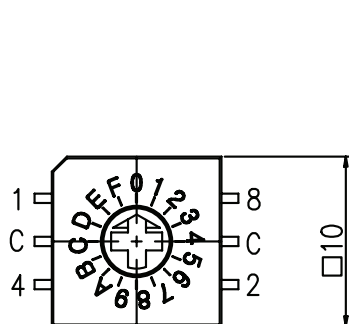

Section A-A'
 ACTUATOR

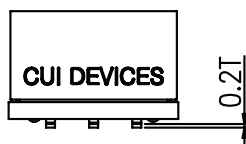
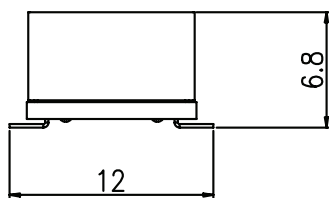

TYPE	POS	CODE				
		C	1	2	4	8
16 POSITION	0	●	○	○	○	○
	1	●	●	○	○	○
	2	●	○	●	○	○
	3	●	●	●	○	○
	4	●	○	○	●	○
	5	●	●	○	●	○
	6	●	○	●	●	○
	7	●	●	●	●	○
	8	●	○	○	○	●
	9	●	●	○	○	●
	A	●	○	●	○	●
	B	●	●	●	○	●
	C	●	○	○	●	●
	D	●	●	○	●	●
	E	●	○	●	●	●
	F	●	●	●	●	●

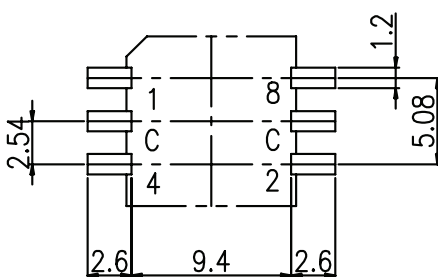
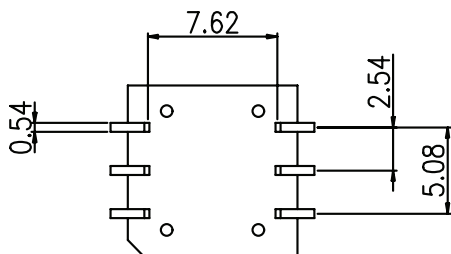

Recommended PCB Layout
 Top View

MECHANICAL DRAWING (NOTCHED CAP)

units: mm
 tolerance: ±0.1 mm
 unless otherwise specified

DESCRIPTION	MATERIAL	PLATING/COLOR
housing	PA66 (UL94V-0)	gray

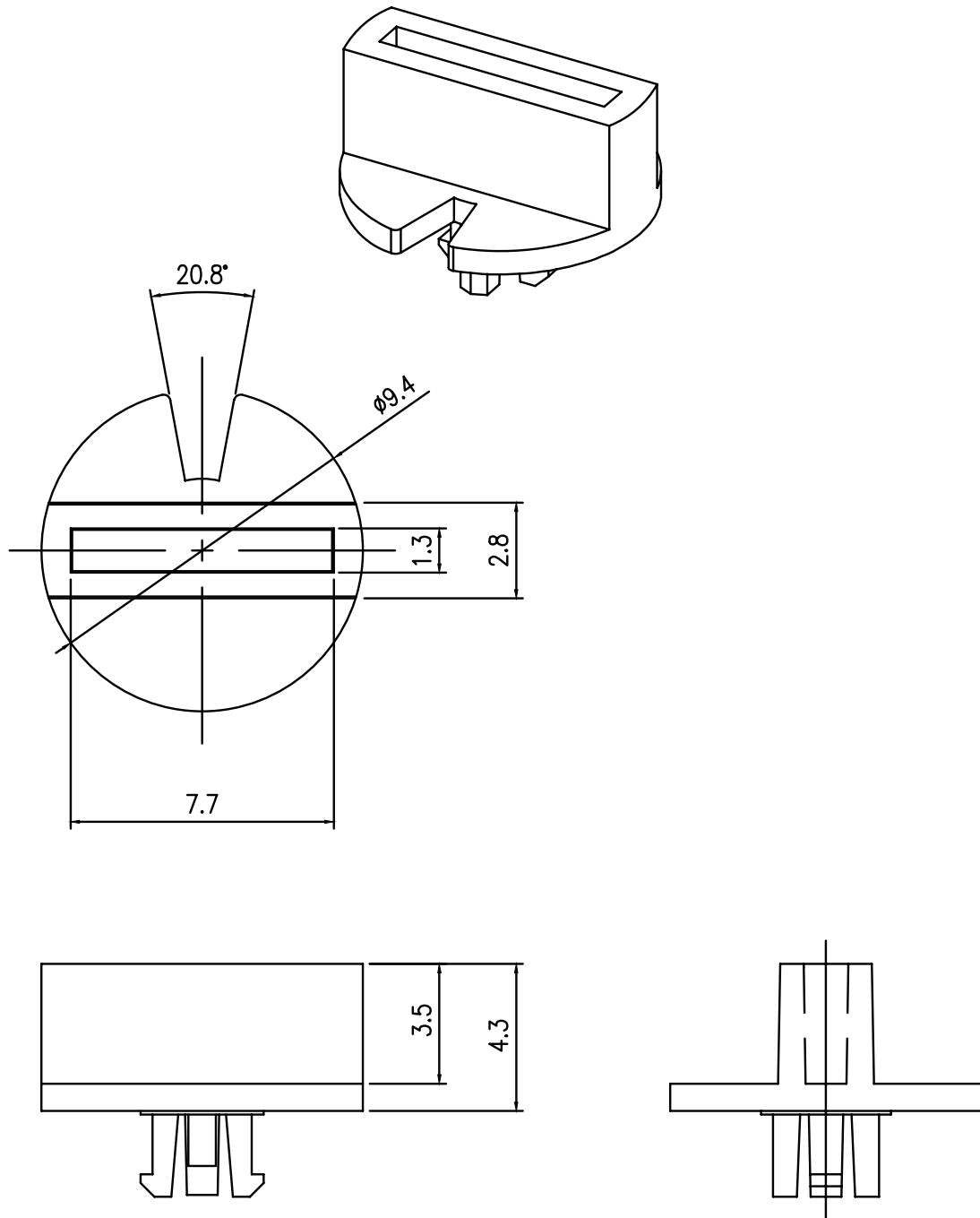

MECHANICAL DRAWING (RAISED SLOTTED CAP)

units: mm
 tolerance: ±0.3 mm
 unless otherwise specified

DESCRIPTION	MATERIAL	PLATING/COLOR
housing	PA66 (UL94V-0)	black

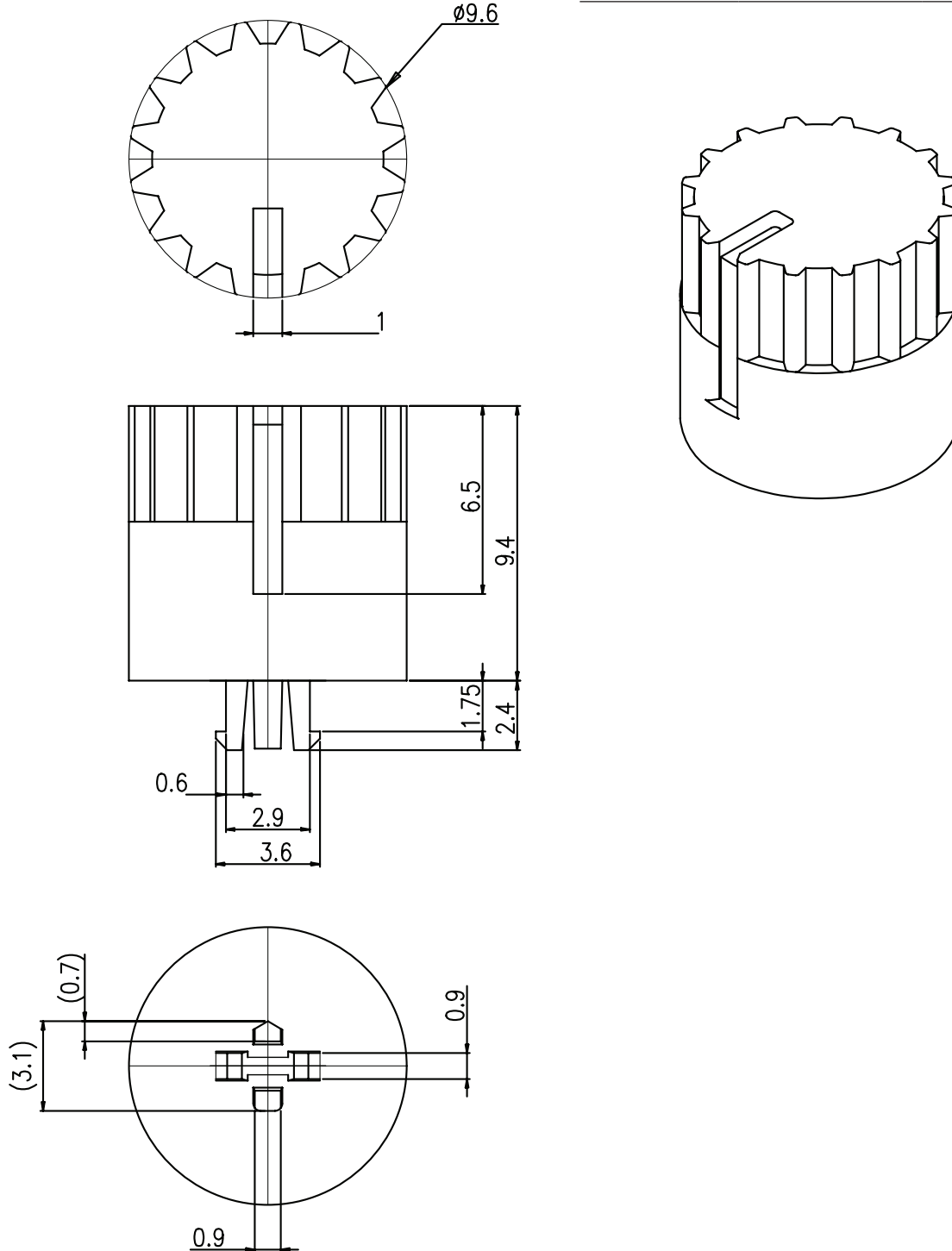

MECHANICAL DRAWING (NUMBERED DIAL)

units: mm
 tolerance: ± 0.3 mm
 unless otherwise specified

DESCRIPTION	MATERIAL	PLATING/COLOR
housing	PA66 (UL94V-0)	red with white letters

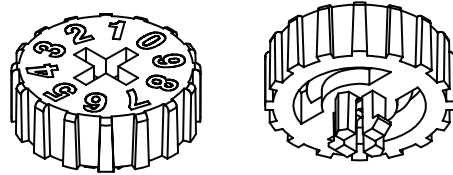

Position	Direction
04	
08	
10	
16	

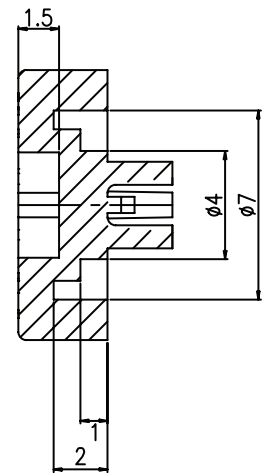
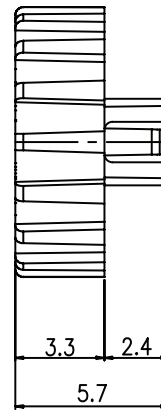
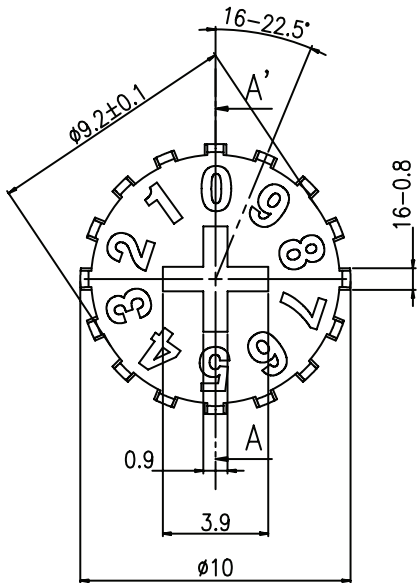

SECTION A-A'

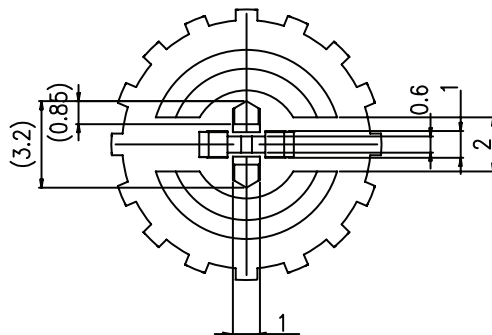
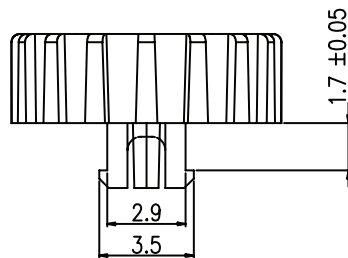

SOLDERABILITY

parameter	conditions/description	min	typ	max	units
hand soldering	for maximum 3 seconds			350	°C
reflow soldering	for maximum 5 seconds			260	°C

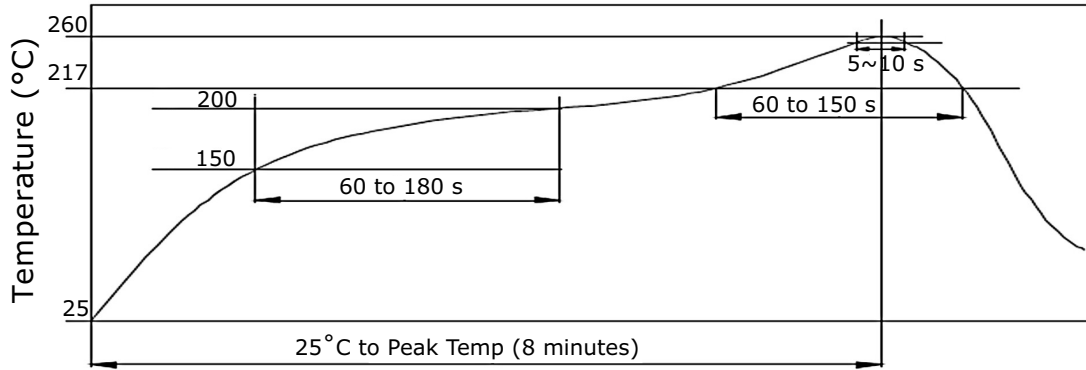

PACKAGING

units: mm

Reel Size: Ø330 mm

Reel QTY: 600 pcs per reel

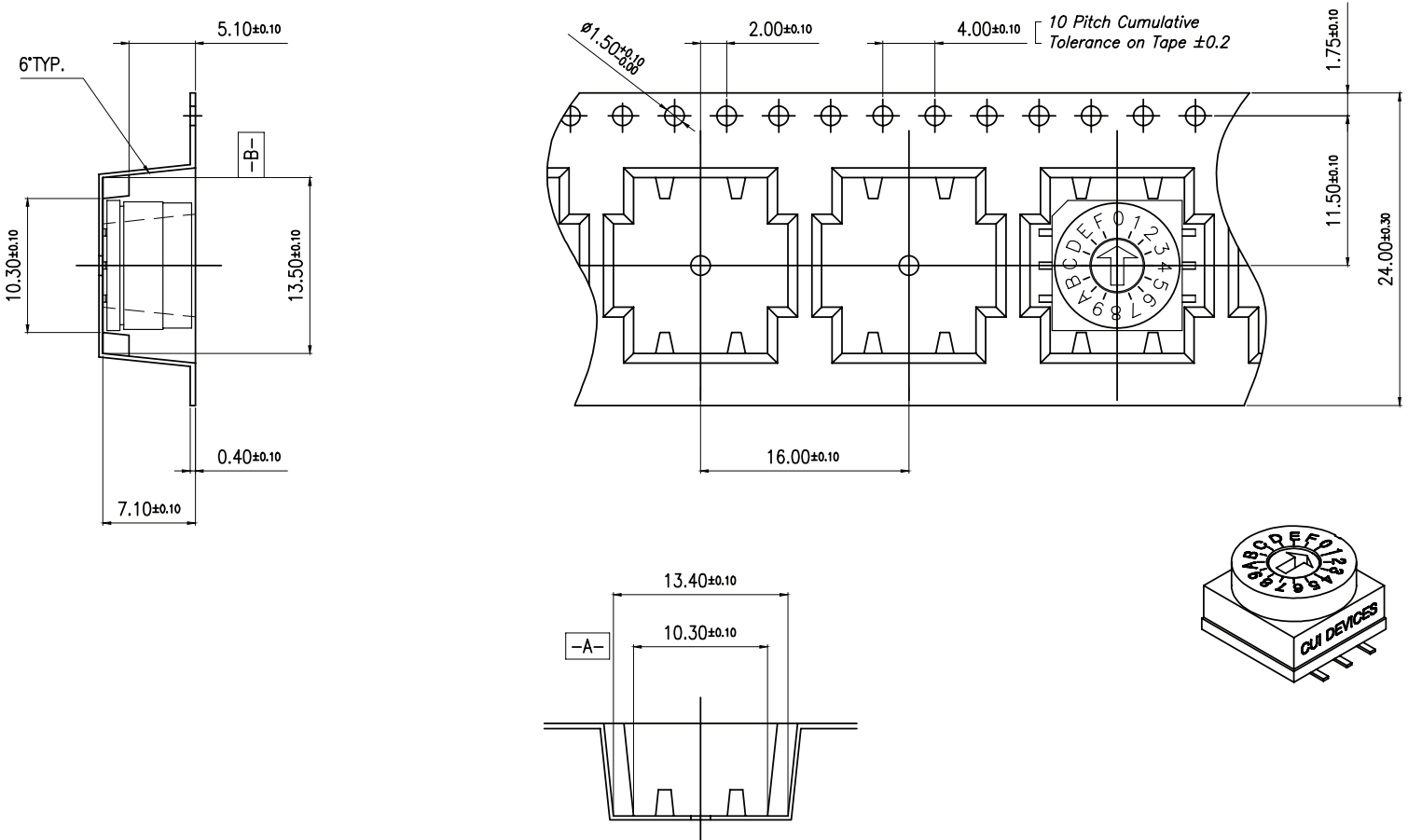

REVISION HISTORY

rev.	description	date
1.0	initial release	05/30/2023

The revision history provided is for informational purposes only and is believed to be accurate.



CUI Devices offers a one (1) year limited warranty. Complete warranty information is listed on our website.

CUI Devices reserves the right to make changes to the product at any time without notice. Information provided by CUI Devices is believed to be accurate and reliable. However, no responsibility is assumed by CUI Devices for its use, nor for any infringements of patents or other rights of third parties which may result from its use.

CUI Devices products are not authorized or warranted for use as critical components in equipment that requires an extremely high level of reliability. A critical component is any component of a life support device or system whose failure to perform can be reasonably expected to cause the failure of the life support device or system, or to affect its safety or effectiveness.

cuidevices.com