

C3B

铝壳干式直流滤波电容器 DC-Link Capacitor(Dry-Type, Aluminum case)

■ 外形图 Outline Drawing

D ≤ 116mm

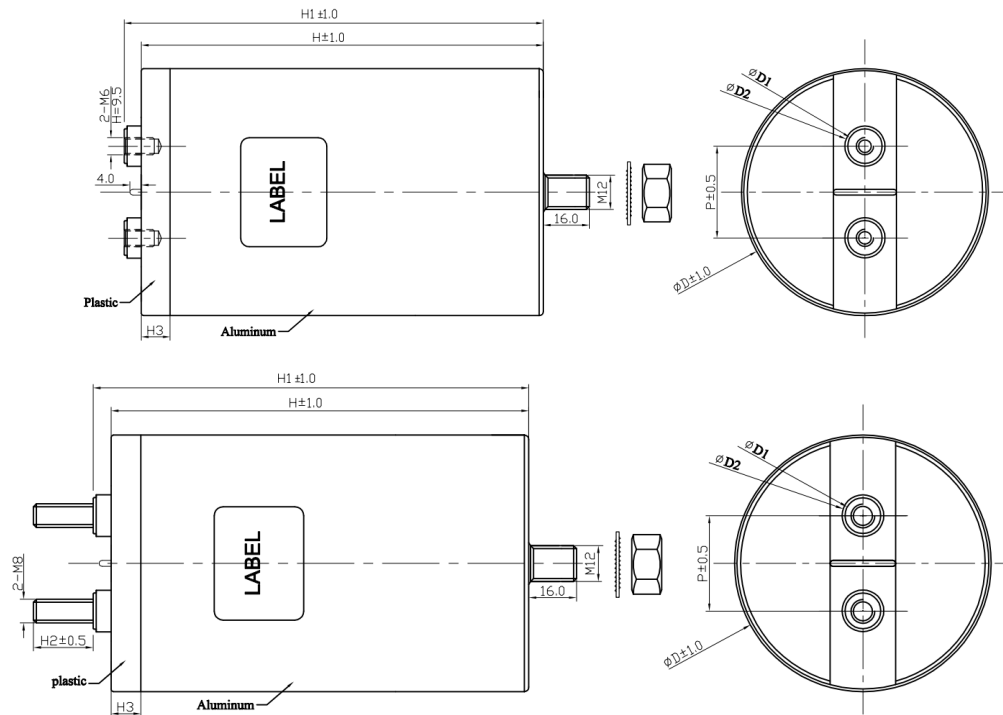

D=136mm

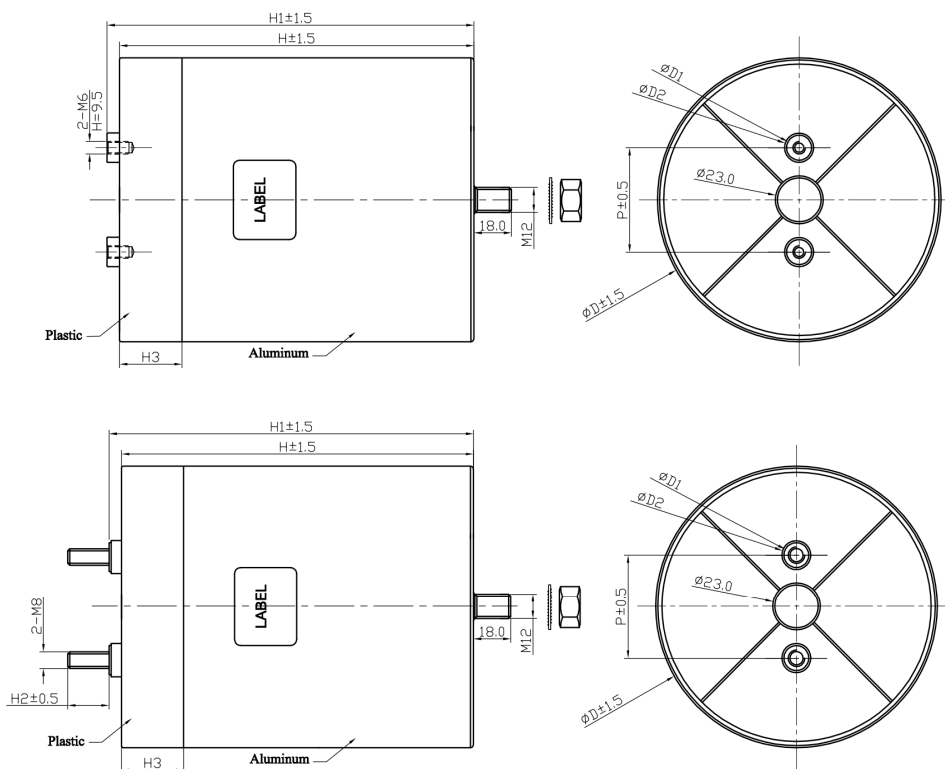



尺寸附加说明 Additional remark of dimensions

D=76mm	P=32mm; D1=12mm; D2=14mm; H3=10mm	
D=86mm	P=32mm; D1=12mm; D2=14mm; H3=10mm or 45mm	
	P=45mm;	Female terminals: D1=14mm; D2=16mm; H3=10mm or 45mm
		Male terminals: D1=16mm; D2=20mm; H3=10mm or 45mm
D=100mm	P=50mm; D1=14mm; D2=16mm;	H ≤ 100mm, H3=10mm
		H > 100mm, H3=45mm
D=116mm	P=50mm; D1=14mm; D2=16mm;	H ≤ 100mm, H3=10mm
		H > 100mm, H3=45mm
D=136mm	P=50mm; D1=14mm; D2=16mm; H3=45mm	
H3 can be changed in pursuance of customer's request. (H3=45mm when rated voltage > 1 500Vdc)		

■ 特点

- 应用于直流滤波电路中,可替代电解电容
- 等效串联电阻小,能承受较大的纹波电流
- 自感小
- 有自愈性
- 寿命长
- 铝壳,树脂灌封

■ Features

- Used in DC-Link circuits, can replace electrolytic capacitors
- Low ESR, high ripple current handling capabilities
- Low L_s
- Self-healing property
- Long lifetime
- Aluminum case, filled with resin

■ 应用场合

- 风能发电、太阳能发电用变频器上
- 交通工具,如:电动车和混合动力车
- 焊接设备,电梯,电机驱动

■ Applications

- Used in inverters of wind power and solar power
- Transportation: EV or HEV
- Welders, Elevators, Motor Driver systems

■ 安全认证 Safety Approvals

	TUV Rheinland (德国)	EN 61071:2007, EN 61881-1: 2011, 600Vdc ~ 4 000Vdc, 5μF~5 600μF, -40°C/85°C, 证书号(Certificate No.):R 50266039
	UL (美国)	UL 810 (construction only), max.5000Vdc, 90°C File No.: E256238, CCN: CZDS2

■ 技术要求 Specifications

引用标准 Reference Standard	GB/T 17702 (IEC 61071)
气候类别 Climatic Category	D ≤ 116mm: 40/85/56 D = 136mm: 40/80/56
工作温度范围 Operating Temperature Range	D ≤ 116mm: -40°C ~ 85°C ($\theta_{hs} \leq 85^\circ\text{C}$) D = 136mm: -40°C ~ 80°C ($\theta_{hs} \leq 80^\circ\text{C}$)
贮存温度范围 Storage temperature range	-40°C ~ 85°C
电压范围 Voltage Range	600Vdc ~ 4 000Vdc
电容量范围 Capacitance Range	24μF ~ 5 600μF
电容量偏差 Capacitance Tolerance	±5%(J), ±10%(K)
耐电压(两极之间) Test Voltage Between Terminals	1.5U _N (10s, 20°C ± 5°C)
耐电压(极壳之间) Test Voltage Between Terminals And Case	U _N < 1 500Vdc, 3 000Vac(10s, 50Hz, 20°C ± 5°C) U _N ≥ 1 500Vdc, ($\sqrt{2}$ U _N +1 000)Vac(10s, 50Hz, 20°C ± 5°C)
介质损耗角正切 tanδ _d	2 × 10 ⁻⁴

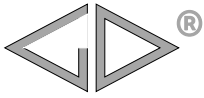

C3B

IR × C _N	≥5 000s (20°C, 500Vdc, 1min)	
过电压 Over Voltage	1.1 U _N (30% of on-load-dur.)	
	1.15 U _N (30min/day)	
	1.2 U _N (5min/day)	
	1.3 U _N (1min/day)	
	1.5 U _N (30ms every time, 1000times during the life of the capacitor)	
预期寿命 Expected lifetime	100 000h @ U _N , θ _{hs} =70°C	
失效率 Failure rate	50 FIT	
最高使用海拔 Max. Altitude	2 000m	
安装 Installation	方向 Position	任意方向 Any Position
	引出端形式 Terminal form	螺栓式 Male Terminals
		螺孔式 Thread hole type
	安装形式 Fixed style	下部螺栓 Bottom-bolt
中部卡圈 Ring-clip in the middle of case		
最大安装扭矩 Max. Torque of Installation	10N·m	
最大电极扭矩 Max. Torque of terminals	M6:5N·m	M8:6N·m

备注: 如果海拔使用高度超过了 2 000m, 应该考虑海拔对对流冷却和外绝缘的影响。

The effect of altitude on convection cooling and external insulation should be taken into consideration, if the altitude exceeds 2 000m.

■ 产品编码说明 Part number system

15 位产品代码如下:

The 15 digits part number is formed as follow:

1	2	3	4	5	6	7	8	9	10	11	12	13	14	15
C	3	B												

第 1~3 位	型号代码	Digit 1 to 3	Series code
第 4~5 位	直流额定电压	Digit 4 to 5	DC rated voltage
	1U=600V 1V=700V 2K=800V		1U=600V 1V=700V 2K=800V
	1X=900V 3A=1 000V 1M=1 100V		1X=900V 3A=1 000V 1M=1 100V
	3L=1 200V 2M=1 300V 3M=1 400V		3L=1 200V 2M=1 300V 3M=1 400V
	4M=1 500V 3D=2 000V 2N=2 200V		4M=1 500V 3D=2 000V 2N=2 200V
	1N=2 400V 3N=2 600V 6P=2 800V		1N=2 400V 3N=2 600V 6P=2 800V
	4Q=3 000V 6Q=3 200V 7R=3 600V		4Q=3 000V 6Q=3 200V 7R=3 600V
	3G=4 000V		3G=4 000V
第 6~8 位	标称容量	Digit 6 to 8	Rated capacitance value
	举例: 127=12 × 10 ⁷ pF=120μF		for example: 127=12 × 10 ⁷ pF=120μF
第 9 位	容量偏差	Digit 9	Capacitance tolerance
	J=±5%, K=±10%		J=±5%, K=±10%
第 10~15 位	内部特征码	Digit 10 to 15	Internal use



■ 预期寿命曲线 Expected lifetime curve

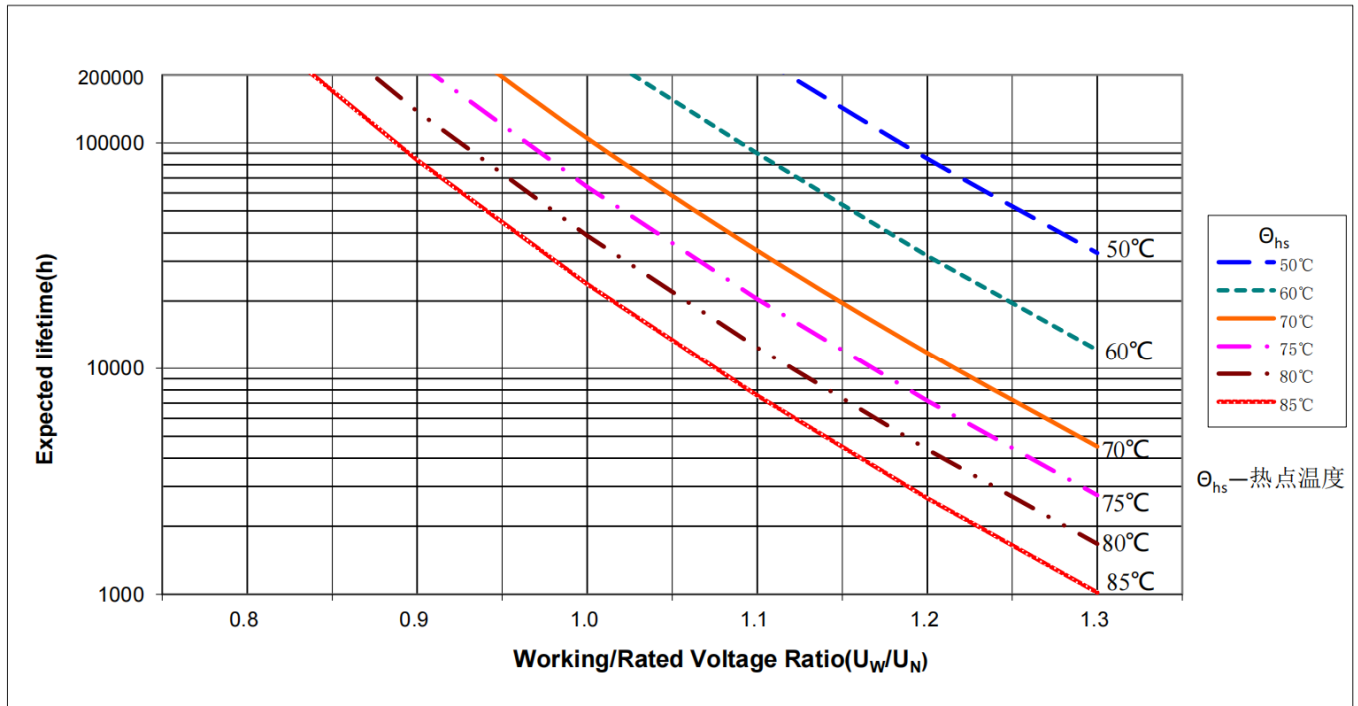

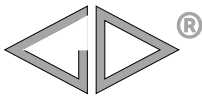

C3B

■ 技术参数 Technical data

U _N (Vdc)	C _N (μF)	ESR @1kHz (mΩ)	L _s (nH)	R _{th} (K/W)	Ī (A)	I _{max} (A)			Dimension (mm)			Weight (kg)	Part number
						40°C	50°C	60°C	ΦD	H	H1		
600	480	1.5	45	5.6	1 560	70	65	55	76	95	101	0.60	C3B1U487-*****
	650	1.9	50	4.7	1 560	70	63	53	76	120	126	0.70	C3B1U657-*****
	780	2.2	55	4.6	1 550	67	59	50	76	140	146	0.75	C3B1U787-*****
	820	1.5	40	4.3	3 060	70	70	62	76	155	161	0.90	C3B1U827-*****
	950	1.5	45	4.2	3 090	70	70	63	76	174	180	1.00	C3B1U957-*****
	650	1.2	45	5.1	2 120	70	70	64	86	95	101	0.72	C3B1U657-*****
	880	1.5	50	4.7	2 110	70	70	60	86	120	126	1.00	C3B1U887-*****
	1000	1.8	55	4.6	2 070	70	65	55	86	136	142	1.10	C3B1U108-*****
	1100	1.7	55	4.6	2 180	70	67	57	86	140	146	1.15	C3B1U118-*****
	1100	1.4	40	4.4	4 110	70	70	64	86	155	161	1.25	C3B1U118-*****
	1300	1.4	45	4.3	4 230	70	70	64	86	174	180	1.30	C3B1U138-*****
	2000	1.1	55	3.0	6 510	70	70	70	86	252	258	1.80	C3B1U208-*****
	900	1.3	45	4.7	2 900	70	70	58	100	95	100	1.20	C3B1U907-*****
	1 200	1.4	50	4.1	2 850	70	70	58	100	120	125	1.48	C3B1U128-*****
	1 400	1.5	55	3.9	2 870	70	70	58	100	136	141	1.66	C3B1U148-*****
	1 500	1.6	55	3.8	2 740	70	70	58	100	140	145	1.72	C3B1U158-*****
	1 600	1.0	40	3.5	5 920	70	70	70	100	155	160	1.99	C3B1U168-*****
	1 800	1.0	45	3.2	5 800	70	70	70	100	174	179	2.28	C3B1U188-*****
	1 200	0.7	45	5.4	3 900	80	80	80	116	95	100	1.20	C3B1U128-*****
	1 600	1.0	50	5.0	3 830	80	80	70	116	120	125	1.50	C3B1U168-*****
2 000	1.1	55	4.9	3 960	80	80	67	116	140	145	1.75	C3B1U208-*****	
2 100	0.8	40	3.6	7 840	100	100	92	116	158	163	2.00	C3B1U218-*****	
2 400	0.9	45	3.4	7 810	100	100	90	116	174	179	2.20	C3B1U248-*****	
3 000	0.8	50	2.7	11 200	100	100	100	116	230	235	2.80	C3B1U308-*****	
5 600	0.8	60	2.0	15 940	100	100	100	136	295	300	4.90	C3B1U568-*****	
700	360	1.6	45	5.6	1 560	70	63	53	76	95	101	0.60	C3B1V367-*****
	480	2.1	50	4.7	1 530	68	60	50	76	120	126	0.70	C3B1V487-*****
	580	2.4	55	4.6	1 530	64	56	48	76	140	146	0.75	C3B1V587-*****
	620	1.5	40	4.3	3 090	70	70	62	76	155	161	0.90	C3B1V627-*****
	720	1.6	45	4.2	3 120	70	70	61	76	174	180	1.00	C3B1V727-*****
	480	1.3	45	5.1	2 080	70	70	61	86	95	101	0.72	C3B1V487-*****
	650	1.7	50	4.7	2 080	70	66	56	86	120	126	1.00	C3B1V657-*****
	750	2.0	55	4.6	2 070	70	62	52	86	136	142	1.10	C3B1V757-*****
	780	1.9	55	4.6	2 060	70	63	53	86	140	146	1.15	C3B1V787-*****
	820	1.4	40	4.4	4 080	70	70	64	86	155	161	1.25	C3B1V827-*****
	950	1.5	45	4.3	4 120	70	70	62	86	174	180	1.30	C3B1V957-*****
	1 500	1.1	55	3.0	6 500	70	70	70	86	252	258	1.80	C3B1V158-*****
	650	1.4	45	4.7	2 710	70	69	56	100	95	100	1.20	C3B1V657-*****
	900	1.5	50	4.1	2 760	70	69	56	100	120	125	1.47	C3B1V907-*****
	1 000	1.7	55	3.9	2 650	70	67	55	100	136	141	1.67	C3B1V108-*****
	1 100	1.7	55	3.8	2 790	70	68	56	100	140	145	1.69	C3B1V118-*****
	1 100	1.0	40	3.5	5 260	70	70	70	100	155	160	2.01	C3B1V118-*****
	1 300	1.1	45	3.2	5 420	70	70	70	100	174	179	2.28	C3B1V138-*****
	920	0.7	45	5.4	3 990	80	80	80	116	95	100	1.20	C3B1V927-*****
	1 200	1.0	50	5.0	3 830	80	80	70	116	120	125	1.50	C3B1V128-*****
1 500	1.1	55	4.9	3 950	80	80	68	116	140	145	1.75	C3B1V158-*****	
1 500	0.8	40	3.6	7 460	100	100	93	116	158	163	2.00	C3B1V158-*****	
1 800	1.0	45	3.4	7 800	100	100	85	116	174	179	2.20	C3B1V188-*****	
2 300	0.8	50	2.7	11 440	100	100	100	116	230	235	2.80	C3B1V238-*****	
4 200	0.8	60	2.0	15 920	100	100	100	136	295	300	4.90	C3B1V428-*****	

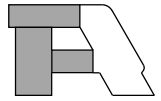

■ 技术参数 Technical data

U _N (Vdc)	C _N (μF)	ESR @1kHz (mΩ)	L _s (nH)	R _{th} (K/W)	İ (A)	I _{max} (A)			Dimension (mm)			Weight (kg)	Part number
						40°C	50°C	60°C	ΦD	H	H1		
800	290	1.7	45	5.6	1530	69	61	51	76	95	101	0.60	C3B2K297-*****
	400	2.2	50	4.7	1530	66	58	49	76	120	126	0.70	C3B2K407-*****
	480	2.5	55	4.6	1560	63	55	47	76	140	146	0.75	C3B2K487-*****
	480	1.6	40	4.3	1540	70	70	60	76	155	161	0.90	C3B2K487-*****
	560	1.7	45	4.2	2910	70	70	59	76	174	180	1.00	C3B2K567-*****
	380	1.4	45	5.1	2960	70	70	59	86	95	101	0.72	C3B2K387-*****
	520	1.8	50	4.7	2010	70	64	54	86	120	126	1.00	C3B2K527-*****
	580	2.0	55	4.6	2020	70	62	52	86	136	142	1.10	C3B2K587-*****
	630	2.1	55	4.6	1950	68	60	51	86	140	146	1.15	C3B2K637-*****
	650	1.5	40	4.4	2030	70	70	62	86	155	161	1.25	C3B2K657-*****
	750	1.6	45	4.3	3940	70	70	60	86	174	180	1.30	C3B2K757-*****
	1100	1.2	55	3.0	3960	70	70	70	86	252	258	1.80	C3B2K118-*****
	500	1.4	45	4.7	2620	70	67	55	100	95	100	1.20	C3B2K507-*****
	700	1.6	50	4.1	2700	70	67	55	100	120	125	1.47	C3B2K707-*****
	800	1.8	55	3.9	2660	70	66	54	100	136	141	1.65	C3B2K807-*****
	850	1.8	55	3.8	2700	70	66	54	100	140	145	1.68	C3B2K857-*****
	900	1.1	40	3.5	5400	70	70	70	100	155	160	1.98	C3B2K907-*****
	1000	1.1	45	3.2	5230	70	70	70	100	174	179	2.28	C3B2K108-*****
	720	0.8	45	5.4	3800	80	80	76	116	95	100	1.20	C3B2K727-*****
	980	1.1	50	5.0	3810	80	79	67	116	120	125	1.50	C3B2K987-*****
1200	1.2	55	4.9	3860	80	77	65	116	140	145	1.75	C3B2K128-*****	
1200	0.85	40	3.6	7280	100	100	90	116	158	163	2.00	C3B2K128-*****	
1500	1.0	45	3.4	7920	100	100	85	116	174	179	2.20	C3B2K158-*****	
1800	0.8	50	2.7	10910	100	100	100	116	230	235	2.80	C3B2K188-*****	
3200	0.8	60	2.0	14780	100	100	100	136	295	300	4.90	C3B2K328-*****	
900	290	2.0	45	5.6	1530	63	56	47	76	95	101	0.60	C3B1X297-*****
	400	2.6	50	4.7	1560	61	54	45	76	120	126	0.70	C3B1X407-*****
	480	2.9	55	4.6	1540	58	51	43	76	140	146	0.75	C3B1X487-*****
	480	1.7	40	4.3	2910	70	69	58	76	155	161	0.90	C3B1X487-*****
	560	1.8	45	4.2	2960	70	68	58	76	174	180	1.00	C3B1X567-*****
	380	1.6	45	5.1	2010	70	65	55	86	95	101	0.72	C3B1X387-*****
	520	2.1	50	4.7	2020	68	60	50	86	120	126	1.00	C3B1X527-*****
	580	2.2	55	4.6	1950	67	59	50	86	136	142	1.10	C3B1X587-*****
	630	2.4	55	4.6	2030	64	56	48	86	140	146	1.15	C3B1X637-*****
	650	1.5	40	4.4	3940	70	70	62	86	155	161	1.25	C3B1X657-*****
	750	1.6	45	4.3	3960	70	70	60	86	174	180	1.30	C3B1X757-*****
	1100	1.3	55	3.0	5810	70	70	70	86	252	258	1.80	C3B1X118-*****
	500	1.4	45	4.7	2620	70	67	55	100	95	100	1.20	C3B1X507-*****
	700	1.6	50	4.1	2700	70	67	55	100	120	125	1.47	C3B1X707-*****
	800	1.8	55	3.9	2660	70	66	54	100	136	141	1.65	C3B1X807-*****
	850	1.8	55	3.8	2700	70	66	54	100	140	145	1.68	C3B1X857-*****
	900	1.1	40	3.5	5400	70	70	70	100	155	160	1.98	C3B1X907-*****
	1000	1.1	45	3.2	5230	70	70	70	100	174	179	2.28	C3B1X108-*****
	720	0.9	45	5.4	3800	80	80	71	116	95	100	1.20	C3B1X727-*****
	980	1.2	50	5.0	3810	80	76	64	116	120	125	1.50	C3B1X987-*****
1200	1.4	55	4.9	3860	80	71	60	116	140	145	1.75	C3B1X128-*****	
1200	0.9	40	3.6	7280	100	100	87	116	158	163	2.00	C3B1X128-*****	
1500	1.1	45	3.4	7920	100	96	81	116	174	179	2.20	C3B1X158-*****	
1800	0.8	50	2.7	10910	100	100	100	116	230	235	2.80	C3B1X188-*****	
3200	0.8	60	2.0	14780	100	100	100	136	295	300	4.90	C3B1X328-*****	

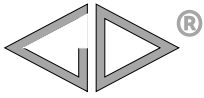

C3B

■ 技术参数 Technical data

U _N (Vdc)	C _N (μF)	ESR @1kHz (mΩ)	L _s (nH)	R _{th} (K/W)	Ī (A)	I _{max} (A)			Dimension (mm)			Weight (kg)	Part number
						40°C	50°C	60°C	ΦD	H	H1		
1 000	220	2.2	45	5.6	1 460	60	53	45	76	95	101	0.60	C3B3A227-*****
	300	2.9	50	4.7	1 460	57	51	43	76	120	126	0.70	C3B3A307-*****
	360	3.3	55	4.6	1 450	54	48	41	76	140	146	0.75	C3B3A367-*****
	360	1.9	40	4.3	2 740	70	65	55	76	155	161	0.90	C3B3A367-*****
	420	2.0	45	4.2	2 780	70	65	55	76	174	180	1.00	C3B3A427-*****
	290	1.8	45	5.1	1 920	70	62	52	86	95	101	0.72	C3B3A297-*****
	400	2.3	50	4.7	1 950	65	57	48	86	120	126	1.00	C3B3A407-*****
	470	2.2	55	4.6	1 980	67	59	50	86	136	142	1.10	C3B3A477-*****
	480	2.6	55	4.6	1 930	61	54	46	86	140	146	1.15	C3B3A487-*****
	500	1.6	40	4.4	3 800	70	70	60	86	155	161	1.25	C3B3A507-*****
	560	1.7	45	4.3	3 710	70	69	58	86	174	180	1.30	C3B3A567-*****
	900	1.3	55	3.0	5 960	70	70	70	86	252	258	1.80	C3B3A907-*****
	380	1.5	45	4.7	2 490	70	65	53	100	95	100	1.18	C3B3A387-*****
	500	1.8	50	4.1	2 410	70	64	52	100	120	125	1.47	C3B3A507-*****
	600	1.9	55	3.9	2 500	70	63	52	100	136	141	1.63	C3B3A607-*****
	650	1.9	55	3.8	2 590	70	64	52	100	140	145	1.66	C3B3A657-*****
	650	1.1	40	3.5	4 890	70	70	70	100	155	160	1.97	C3B3A657-*****
	780	1.1	45	3.2	5 110	70	70	70	100	174	179	2.24	C3B3A787-*****
	540	1.0	45	5.4	3 570	80	80	68	116	95	100	1.20	C3B3A547-*****
	740	1.4	50	5.0	3 610	80	70	59	116	120	125	1.50	C3B3A747-*****
900	1.5	55	4.9	3 620	78	69	58	116	140	145	1.75	C3B3A907-*****	
900	0.95	40	3.6	6 840	100	100	85	116	158	163	2.00	C3B3A907-*****	
1 100	1.2	45	3.4	7 280	100	92	78	116	174	179	2.20	C3B3A118-*****	
1 400	0.9	50	2.7	10 630	100	100	100	116	230	235	2.80	C3B3A148-*****	
2 500	0.9	60	2.0	14 470	100	100	100	136	295	300	4.90	C3B3A258-*****	
1 100	180	2.3	45	5.6	1 400	59	52	44	76	95	101	0.60	C3B1M187-*****
	250	3.0	50	4.7	1 430	56	50	42	76	120	126	0.70	C3B1M257-*****
	300	3.5	55	4.6	1 420	53	47	39	76	140	146	0.75	C3B1M307-*****
	310	1.9	40	4.3	2 770	70	65	55	76	155	161	0.90	C3B1M317-*****
	360	2.0	45	4.2	2 800	70	65	55	76	174	180	1.00	C3B1M367-*****
	240	1.9	45	5.1	1 870	68	60	51	86	95	101	0.72	C3B1M247-*****
	330	2.4	50	4.7	1 890	63	56	47	86	120	126	1.00	C3B1M337-*****
	420	2.3	55	4.6	2 080	65	58	49	86	136	142	1.10	C3B1M427-*****
	420	1.7	40	4.4	3 750	70	63	52	86	155	161	1.25	C3B1M427-*****
	500	1.8	45	4.3	3 730	70	67	57	86	174	180	1.30	C3B1M507-*****
	750	1.3	55	3.0	5 840	70	70	70	86	252	258	1.80	C3B1M757-*****
	350	1.5	45	4.7	2 640	70	65	53	100	95	100	1.19	C3B1M357-*****
	450	1.8	50	4.1	2 500	70	63	51	100	120	125	1.49	C3B1M457-*****
	520	2.0	55	3.9	2 500	70	62	50	100	136	141	1.67	C3B1M527-*****
	550	2.1	55	3.8	2 520	70	62	51	100	140	145	1.71	C3B1M557-*****
	580	1.1	40	3.5	5 020	70	70	70	100	155	160	2.00	C3B1M587-*****
	650	1.2	45	3.2	4 900	70	70	70	100	174	179	2.30	C3B1M657-*****
	450	1.0	45	5.4	3 500	80	80	68	116	95	100	1.20	C3B1M457-*****
	620	1.4	50	5.0	3 550	80	70	59	116	120	125	1.50	C3B1M627-*****
	750	1.6	55	4.9	3 550	75	66	56	116	140	145	1.75	C3B1M757-*****
780	0.9	40	3.6	6 960	100	100	85	116	158	163	2.00	C3B1M787-*****	
920	1.1	45	3.4	7 150	100	96	81	116	174	179	2.20	C3B1M927-*****	
1 200	0.9	50	2.7	10 710	100	100	100	116	230	235	2.80	C3B1M128-*****	
2 200	0.9	60	2.0	14 960	100	100	100	136	295	300	4.90	C3B1M228-*****	

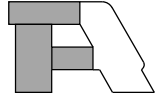

■ 技术参数 Technical data

U _N (Vdc)	C _N (μF)	ESR @1kHz (mΩ)	L _s (nH)	R _{th} (K/W)	İ (A)	I _{max} (A)			Dimension (mm)			Weight (kg)	Part number
						40°C	50°C	60°C	ΦD	H	H1		
1200	140	2.7	45	5.6	1 330	55	48	41	76	95	101	0.60	C3B3L147-*****
	200	3.4	50	4.7	1 400	53	47	40	76	120	126	0.70	C3B3L207-*****
	240	3.9	55	4.6	1 380	50	44	37	76	140	146	0.75	C3B3L247-*****
	240	2.0	40	4.3	2 630	70	64	54	76	155	161	0.90	C3B3L247-*****
	280	2.1	45	4.2	2 670	70	63	53	76	174	180	1.00	C3B3L287-*****
	190	2.1	45	5.1	1 810	65	57	48	86	95	101	0.72	C3B3L197-*****
	260	2.7	50	4.7	1 810	60	53	44	86	120	126	1.00	C3B3L267-*****
	320	2.5	55	4.6	1 930	63	55	47	86	136	142	1.10	C3B3L327-*****
	330	3.0	55	4.6	1 900	57	50	43	86	140	146	1.15	C3B3L337-*****
	330	1.8	40	4.4	3 610	70	66	56	86	155	161	1.25	C3B3L337-*****
	380	1.9	45	4.3	3 610	70	65	55	86	174	180	1.30	C3B3L387-*****
	580	1.5	55	3.0	5 520	70	70	70	86	252	258	1.80	C3B3L587-*****
	250	1.7	45	4.7	2 320	70	61	50	100	95	100	1.19	C3B3L257-*****
	350	2.0	50	4.1	2 390	70	61	50	100	120	125	1.45	C3B3L357-*****
	400	2.2	55	3.9	2 360	69	59	49	100	136	141	1.63	C3B3L407-*****
	420	2.2	55	3.8	2 370	69	59	49	100	140	145	1.67	C3B3L427-*****
	450	1.2	40	3.5	4 790	70	70	70	100	155	160	1.96	C3B3L457-*****
	500	1.2	45	3.2	4 640	70	70	70	100	174	179	2.26	C3B3L507-*****
	360	1.1	45	5.4	3 420	80	76	64	116	95	100	1.20	C3B3L367-*****
	500	1.6	50	5.0	3 490	75	66	55	116	120	125	1.50	C3B3L507-*****
600	1.8	55	4.9	3 450	71	63	53	116	140	145	1.75	C3B3L607-*****	
620	1.0	40	3.6	6 780	100	98	83	116	158	163	2.00	C3B3L627-*****	
720	1.2	45	3.4	6 740	100	92	78	116	174	179	2.20	C3B3L727-*****	
950	0.9	50	2.7	10 210	100	100	100	116	230	235	2.80	C3B3L957-*****	
1 700	0.9	60	2.0	13 920	100	100	100	136	295	300	4.90	C3B3L178-*****	
1300	120	2.9	45	5.6	1 310	53	46	39	76	95	101	0.60	C3B2M127-*****
	170	3.7	50	4.7	1 360	51	45	38	76	120	126	0.70	C3B2M177-*****
	210	4.1	55	4.6	1 390	49	43	36	76	140	146	0.75	C3B2M217-*****
	210	2.1	40	4.3	2 640	70	62	53	76	155	161	0.90	C3B2M217-*****
	240	2.3	45	4.2	2 620	68	60	51	76	174	180	1.00	C3B2M247-*****
	170	2.2	45	5.1	1 850	63	56	47	86	95	101	0.72	C3B2M177-*****
	230	2.8	50	4.7	1 840	58	52	44	86	120	126	1.00	C3B2M237-*****
	270	2.8	55	4.6	1 860	59	52	44	86	136	142	1.10	C3B2M277-*****
	270	3.3	55	4.6	1 780	54	48	41	86	140	146	1.15	C3B2M277-*****
	280	1.8	40	4.4	3 510	70	66	56	86	155	161	1.25	C3B2M287-*****
	320	1.9	45	4.3	3 490	70	65	55	86	174	180	1.30	C3B2M327-*****
	520	1.5	55	3.0	5 670	70	70	67	86	252	258	1.80	C3B2M527-*****
	210	1.8	45	4.7	2 270	69	60	49	100	95	100	1.19	C3B2M217-*****
	280	2.1	50	4.1	2 230	67	58	48	100	120	125	1.47	C3B2M287-*****
	330	2.3	55	3.9	2 270	66	57	47	100	136	141	1.64	C3B2M337-*****
	360	2.3	55	3.8	2 370	67	58	47	100	140	145	1.67	C3B2M367-*****
	380	1.2	40	3.5	4 720	70	70	69	100	155	160	1.96	C3B2M387-*****
	420	1.3	45	3.2	4 540	70	70	70	100	174	179	2.26	C3B2M427-*****
	320	1.2	45	5.4	3 490	80	73	62	116	95	100	1.20	C3B2M327-*****
	430	1.6	50	5.0	3 440	75	66	55	116	120	125	1.50	C3B2M437-*****
520	1.8	55	4.9	3 430	71	63	53	116	140	145	1.75	C3B2M527-*****	
540	1.0	40	3.6	6 770	100	98	83	116	158	163	2.00	C3B2M547-*****	
630	1.2	45	3.4	6 760	100	92	78	116	174	179	2.20	C3B2M637-*****	
820	0.9	50	2.7	10 100	100	100	100	116	230	235	2.80	C3B2M827-*****	
1 500	1.0	60	2.0	14 080	100	100	100	136	295	300	4.90	C3B2M158-*****	

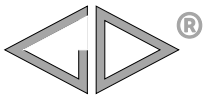

C3B

■ 技术参数 Technical data

U _N (Vdc)	C _N (μF)	ESR @1kHz (mΩ)	L _s (nH)	R _{th} (K/W)	Ī (A)	I _{max} (A)			Dimension (mm)			Weight (kg)	Part number
						40°C	50°C	60°C	ΦD	H	H1		
1 400	100	3.1	45	5.6	1 260	51	45	38	76	95	101	0.60	C3B3M107-*****
	140	4.0	50	4.7	1 290	49	43	36	76	120	126	0.70	C3B3M147-*****
	170	4.6	55	4.6	1 290	46	41	34	76	140	146	0.75	C3B3M177-*****
	170	2.3	40	4.3	2 460	67	59	50	76	155	161	0.90	C3B3M177-*****
	200	2.4	45	4.2	2 520	67	59	50	76	174	180	1.00	C3B3M207-*****
	140	2.4	45	5.1	1 760	61	53	45	86	95	101	0.72	C3B3M147-*****
	190	3.1	50	4.7	1 750	56	49	41	86	120	126	1.00	C3B3M197-*****
	230	2.9	55	4.6	1 800	58	51	43	86	136	142	1.10	C3B3M237-*****
	240	1.9	40	4.4	3 470	70	65	55	86	155	161	1.25	C3B3M247-*****
	270	2.1	45	4.3	3 400	70	62	53	86	174	180	1.30	C3B3M277-*****
	420	1.5	55	3.0	5 210	70	70	70	86	252	258	1.80	C3B3M427-*****
	180	1.8	45	4.7	2 240	68	59	48	100	95	100	1.19	C3B3M187-*****
	250	2.2	50	4.1	2 300	67	58	47	100	120	125	1.45	C3B3M257-*****
	290	2.4	55	3.9	2 300	65	57	46	100	136	141	1.63	C3B3M297-*****
	320	1.2	40	3.5	4 580	70	70	68	100	155	160	1.96	C3B3M327-*****
	360	1.3	45	3.2	4 490	70	70	69	100	174	179	2.26	C3B3M367-*****
	260	1.3	45	5.4	3 220	80	70	59	116	95	100	1.20	C3B3M267-*****
	360	1.8	50	5.0	3 280	70	62	52	116	120	125	1.50	C3B3M367-*****
	450	2.0	55	4.9	3 390	67	59	50	116	140	145	1.75	C3B3M457-*****
	460	1.1	40	3.6	6 540	100	94	79	116	158	163	2.00	C3B3M467-*****
540	1.3	45	3.4	6 690	89	79	66	116	174	179	2.20	C3B3M547-*****	
700	0.9	50	2.7	9 950	100	94	79	116	230	235	2.80	C3B3M707-*****	
1 300	1.05	60	2.0	14 080	100	100	97	136	295	300	4.90	C3B3M138-*****	
1 500	90	3.3	45	5.6	1 220	49	44	37	76	95	101	0.60	C3B4M906-*****
	120	4.4	50	4.7	1 200	47	41	35	76	120	126	0.70	C3B4M127-*****
	150	4.9	55	4.6	1 230	45	39	33	76	140	146	0.75	C3B4M157-*****
	150	2.4	40	4.3	2 340	66	58	49	76	155	161	0.90	C3B4M157-*****
	170	2.5	45	4.2	2 310	65	58	49	76	174	180	1.00	C3B4M177-*****
	120	2.6	45	5.1	1 630	58	51	43	86	95	101	0.72	C3B4M127-*****
	170	3.3	50	4.7	1 690	54	48	40	86	120	126	1.00	C3B4M177-*****
	200	3.0	55	4.6	1 720	57	50	43	86	136	142	1.10	C3B4M207-*****
	210	2.0	40	4.4	3 280	70	63	53	86	155	161	1.25	C3B4M217-*****
	240	2.1	45	4.3	3 260	70	62	53	86	174	180	1.30	C3B4M247-*****
	380	1.5	55	3.0	5 080	70	70	70	86	252	258	1.80	C3B4M387-*****
	160	1.9	45	4.7	2 150	67	58	47	100	95	100	1.18	C3B4M167-*****
	210	2.3	50	4.1	2 080	65	56	46	100	120	125	1.46	C3B4M217-*****
	250	2.5	55	3.9	2 140	64	55	45	100	136	141	1.63	C3B4M257-*****
	280	1.3	40	3.5	4 320	70	70	67	100	155	160	1.96	C3B4M287-*****
	320	1.3	45	3.2	4 300	70	70	68	100	174	179	2.24	C3B4M327-*****
	230	1.4	45	5.4	3 120	77	68	57	116	95	100	1.20	C3B4M237-*****
	320	1.9	50	5.0	3 180	68	60	51	116	120	125	1.50	C3B4M327-*****
	390	2.1	55	4.9	3 200	66	58	49	116	140	145	1.75	C3B4M397-*****
	420	1.1	40	3.6	6 550	100	94	79	116	158	163	2.00	C3B4M427-*****
470	1.3	45	3.4	6 280	89	79	66	116	174	179	2.20	C3B4M477-*****	
600	1.0	50	2.7	9 200	100	89	75	116	230	235	2.80	C3B4M607-*****	
1 100	1.1	60	2.0	12 850	100	100	95	136	295	300	4.90	C3B4M118-*****	



■ 技术参数 Technical data

U _N (Vdc)	C _N (μF)	ESR @1kHz (mΩ)	L _s (nH)	R _{th} (K/W)	Î (A)	I _{max} (A)			Dimension (mm)			Weight (kg)	Part number
						40°C	50°C	60°C	ΦD	H	H1		
2 000	110	3.5	65	4.5	1 830	48	42	35	86	140	146	1.05	C3B3D117-*****
	180	1.8	60	3.2	3 660	78	69	58	86	225	231	1.65	C3B3D187-*****
	180	2.1	60	3.5	3 660	70	61	52	116	120	125	1.60	C3B3D187-*****
	220	2.3	65	3.3	3 660	69	60	51	116	140	145	1.85	C3B3D227-*****
	260	1.1	55	2.9	7 360	100	93	79	116	174	179	2.30	C3B3D267-*****
	360	1.3	60	2.4	7 330	100	93	79	116	225	230	2.85	C3B3D367-*****
	250	1.8	60	2.9	5 090	78	67	55	136	120	125	2.15	C3B3D257-*****
	310	2.0	65	2.7	5 150	77	66	54	136	140	145	2.45	C3B3D317-*****
	360	1.0	55	2.4	10 200	100	99	81	136	175	180	3.15	C3B3D367-*****
	500	1.2	60	2.1	10 100	100	98	80	136	225	230	3.90	C3B3D507-*****
610	1.3	60	1.9	10 100	100	98	80	136	265	270	4.50	C3B3D617-*****	
2 200	90	3.7	65	4.5	1 790	46	41	34	86	140	146	1.05	C3B2N906-*****
	150	1.9	60	3.2	3 670	77	68	57	86	225	231	1.65	C3B2N157-*****
	140	2.2	60	3.6	3 420	67	59	50	116	120	125	1.60	C3B2N147-*****
	170	2.5	65	3.3	3 390	66	58	49	116	140	145	1.85	C3B2N177-*****
	210	1.1	55	2.9	7 150	100	91	77	116	174	179	2.30	C3B2N217-*****
	290	1.4	60	2.4	7 100	100	91	77	116	225	230	2.90	C3B2N297-*****
	200	1.9	60	2.9	4 890	76	66	54	136	120	125	2.15	C3B2N207-*****
	250	2.1	65	2.7	4 990	75	65	53	136	140	145	2.45	C3B2N257-*****
	290	1.0	55	2.4	9 870	100	97	79	136	175	180	3.15	C3B2N297-*****
	400	1.2	60	2.1	9 790	100	96	79	136	225	230	3.90	C3B2N407-*****
500	1.4	60	1.9	9 990	100	97	79	136	265	270	4.50	C3B2N507-*****	
2 400	75	3.9	65	4.5	1 770	45	40	33	86	140	146	1.05	C3B1N756-*****
	120	2.0	60	3.2	3 470	74	65	55	86	225	231	1.65	C3B1N127-*****
	120	2.3	60	3.6	3 470	66	58	49	116	120	125	1.60	C3B1N127-*****
	140	2.6	65	3.3	3 310	64	56	47	116	140	145	1.85	C3B1N147-*****
	170	1.2	55	2.9	6 840	100	89	75	116	174	179	2.30	C3B1N177-*****
	240	1.4	60	2.5	6 940	100	89	75	116	225	230	2.85	C3B1N247-*****
	160	2.0	60	3.0	4 630	73	63	52	136	120	125	2.20	C3B1N167-*****
	200	2.2	65	2.8	4 720	72	63	51	136	140	145	2.50	C3B1N207-*****
	240	1.1	55	2.5	9 660	100	95	78	136	175	180	3.15	C3B1N247-*****
	330	1.3	60	2.1	9 550	100	94	77	136	225	230	3.90	C3B1N337-*****
410	1.4	60	1.9	9 690	100	95	77	136	265	270	4.50	C3B1N417-*****	
2 600	63	4.1	65	4.5	1 730	43	38	32	86	140	146	1.05	C3B3N636-*****
	100	2.1	60	3.2	3 370	72	63	53	86	225	231	1.65	C3B3N107-*****
	100	2.4	60	3.6	3 370	64	57	48	116	120	125	1.60	C3B3N107-*****
	120	2.7	65	3.3	3 310	63	55	47	116	140	145	1.85	C3B3N127-*****
	140	1.2	55	2.9	6 570	98	87	73	116	174	179	2.30	C3B3N147-*****
	200	1.5	60	2.5	6 750	99	87	73	116	225	230	2.85	C3B3N207-*****
	140	2.0	60	3.0	4 730	73	63	51	136	120	125	2.15	C3B3N147-*****
	170	2.3	65	2.8	4 690	71	62	50	136	140	145	2.45	C3B3N177-*****
	200	1.1	55	2.5	9 390	100	94	76	136	175	180	3.15	C3B3N207-*****
	280	1.3	60	2.1	9 590	100	93	76	136	225	230	3.90	C3B3N287-*****
340	1.5	60	1.9	9 380	100	92	76	136	265	270	4.50	C3B3N347-*****	
2 800	54	4.3	65	4.5	1 710	42	37	32	86	140	146	1.05	C3B6P546-*****
	88	2.2	60	3.2	3 430	71	62	53	86	225	231	1.65	C3B6P886-*****
	86	2.5	60	3.6	3 350	63	56	47	116	120	125	1.60	C3B6P866-*****
	100	2.9	65	3.4	3 180	61	53	45	116	140	145	1.85	C3B6P107-*****
	120	1.3	55	2.9	6 500	97	85	72	116	174	179	2.30	C3B6P127-*****
	170	1.5	60	2.5	6 620	96	85	72	116	225	230	2.85	C3B6P177-*****
	120	2.1	60	3.0	4 680	71	62	51	136	120	125	2.15	C3B6P127-*****
	140	2.4	65	2.8	4 450	69	59	49	136	140	145	2.50	C3B6P147-*****
	170	1.1	55	2.5	9 210	100	92	75	136	175	180	3.15	C3B6P177-*****
	240	1.3	60	2.1	9 350	100	92	75	136	225	230	3.90	C3B6P247-*****
290	1.5	60	1.9	9 230	100	91	74	136	265	270	4.50	C3B6P297-*****	

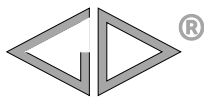

C3B

■ 技术参数 Technical data

U _N (Vdc)	C _N (μF)	ESR @1kHz (mΩ)	L _s (nH)	R _{th} (K/W)	İ (A)	I _{max} (A)			Dimension (mm)			Weight (kg)	Part number
						40°C	50°C	60°C	ΦD	H	H1		
3 000	46	4.6	65	4.6	1 570	41	36	30	86	140	146	1.05	C3B4Q466-*****
	75	2.3	60	3.2	3 150	69	61	51	86	225	231	1.65	C3B4Q756-*****
	74	2.6	60	3.6	3 110	62	54	46	116	120	125	1.60	C3B4Q746-*****
	90	2.9	65	3.3	3 090	60	53	45	116	140	145	1.80	C3B4Q906-*****
	100	1.3	55	3.0	5 840	94	83	70	116	174	179	2.35	C3B4Q107-*****
	140	1.6	60	2.5	5 880	93	82	69	116	225	230	2.90	C3B4Q147-*****
	100	2.2	60	3.0	4 200	69	60	49	136	120	125	2.15	C3B4Q107-*****
	120	2.5	65	2.8	4 120	67	58	47	136	140	145	2.50	C3B4Q127-*****
	140	1.2	55	2.5	8 180	100	89	73	136	175	180	3.15	C3B4Q147-*****
	200	1.4	60	2.2	8 400	100	89	73	136	225	230	3.90	C3B4Q207-*****
250	1.6	60	1.9	8 580	100	89	73	136	265	270	4.50	C3B4Q257-*****	
3 200	40	4.9	65	4.6	1 470	40	35	30	86	140	146	1.05	C3B6Q406-*****
	65	2.4	60	3.2	2 930	67	59	50	86	225	231	1.65	C3B6Q656-*****
	64	2.7	60	3.6	2 880	60	53	45	116	120	125	1.60	C3B6Q646-*****
	78	3.1	65	3.4	2 870	59	52	44	116	140	145	1.80	C3B6Q786-*****
	92	1.3	55	3.0	5 760	94	83	70	116	174	179	2.30	C3B6Q926-*****
	120	1.7	60	2.5	5 410	91	80	68	116	225	230	2.90	C3B6Q127-*****
	90	2.2	60	3.0	4 050	69	59	49	136	120	125	2.15	C3B6Q906-*****
	110	2.5	65	2.8	4 050	67	58	47	136	140	145	2.45	C3B6Q117-*****
	120	1.2	55	2.6	7 520	100	87	71	136	175	180	3.20	C3B6Q127-*****
	180	1.4	60	2.2	8 110	100	89	72	136	225	230	3.85	C3B6Q187-*****
220	1.6	60	1.9	8 100	100	88	72	136	265	270	4.45	C3B6Q227-*****	
3 600	28	4.0	65	4.6	1 650	43	38	32	86	140	146	1.10	C3B7R286-*****
	45	2.0	60	3.3	3 290	72	64	54	86	225	231	1.70	C3B7R456-*****
	44	2.3	60	3.7	3 220	64	57	48	116	120	125	1.65	C3B7R446-*****
	54	2.7	65	3.4	3 190	63	55	47	116	140	145	1.90	C3B7R546-*****
	88	1.4	60	2.5	6 440	98	87	73	116	225	230	3.00	C3B7R886-*****
	110	1.6	60	2.3	6 510	97	85	72	116	265	270	3.45	C3B7R117-*****
	61	2.0	60	3.0	4 460	72	63	51	136	120	125	2.25	C3B7R616-*****
	75	2.3	65	2.8	4 440	71	61	50	136	140	145	2.55	C3B7R756-*****
	120	1.3	60	2.2	8 780	100	92	75	136	225	230	4.05	C3B7R127-*****
	150	1.5	60	2.0	8 880	100	92	75	136	265	270	4.70	C3B7R157-*****
4 000	24	4.2	65	4.6	1 650	42	37	32	86	140	146	1.10	C3B3G246-*****
	38	2.1	60	3.3	3 230	70	62	53	86	225	231	1.70	C3B3G386-*****
	37	2.4	60	3.7	3 140	63	55	47	116	120	125	1.65	C3B3G376-*****
	46	2.8	65	3.4	3 160	61	54	46	116	140	145	1.90	C3B3G466-*****
	74	1.5	60	2.5	6 290	96	85	72	116	225	230	3.00	C3B3G746-*****
	92	1.7	60	2.3	6 330	94	83	70	116	265	270	3.45	C3B3G926-*****
	52	2.1	60	3.0	4 420	71	62	50	136	120	125	2.25	C3B3G526-*****
	64	2.3	65	2.8	4 400	69	60	49	136	140	145	2.55	C3B3G646-*****
	100	1.3	60	2.2	8 500	100	90	73	136	225	230	4.05	C3B3G107-*****
	130	1.5	60	2.0	8 940	100	91	37	136	265	270	4.65	C3B3G137-*****

备注 Note: 1. “.”表示容量偏差。 “.”=capacitance tolerance code, J=±5.0%, K=±10%。

2. “*****”表示内部特征码。 “*****”=Internal use

3. “I_{max}”是指在环境温度(40°C, 50°C, 60°C)下的最大允许电流有效值。在这种条件下, 热点温度将达到最大值。

“I_{max}” = Maxium allowable r.m.s current at θ_{amb}(40°C, 50°C, 60°C). θ_{hs} will reach the maximum value on this condition.

4. “R_{th}”是指在自然冷却条件下, 电容器热点到环境的热阻。 “R_{th}” = R_{th} between hotspot and ambient on natural cooling condition.

5. 上表中所列的尺寸为本产品系列中的常用壳号尺寸, 其它规格尺寸也可以生产。

Sizes above are normally used dimension, other dimension can be produced in pursuance of customer's request.

6. *θ_{hs} = θ_{amb} + I_{rms}² × ESR × R_{th}.