

OSRAM KRTBEILQ51.3A

Datasheet

Published by **ams-OSRAM AG**

Tobelbader Strasse 30, 8141 Premstaetten, Austria

Phone +43 3136 500-0

ams-osram.com

© All rights reserved



Multi Chip LED

KRTBEILQ51.3A

This white-binned RGB LED is finished with a clear casting which leads to very high brightness. All chips can be controlled separately to display various colors including white. Equipped with a silicone lens this device is designed to reliably support long lifetime applications.

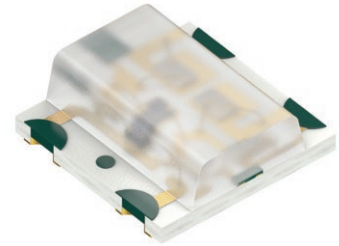

Applications

- Entertainment

Features

- Package: SMT package, clear silicone resin
- Chip technology: InGaAlP on Sapphire / InGaN on Sapphire
- Typ. Radiation: 120° (Lambertian emitter)
- Color: $\lambda_{\text{dom}} = 623 \text{ nm}$ (● red); $\lambda_{\text{dom}} = 526 \text{ nm}$ (● true green); $\lambda_{\text{dom}} = 470 \text{ nm}$ (● blue)
- ESD: 500 V acc. to ANSI/ESDA/JEDEC JS-001 (HBM, Class 1B)

Ordering Information

Type

KRTBEILQ51.3A-5B5C-0112-0-R18

Ordering Code

Q65112A8566

Maximum Ratings

Parameter	Symbol		Values	Values	Values
			● red	● true green	● blue
Operating Temperature	T_{op}	min.	-40 °C	-40 °C	-40 °C
		max.	85 °C	85 °C	85 °C
Storage Temperature	T_{stg}	min.	-40 °C	-40 °C	-40 °C
		max.	100 °C	100 °C	100 °C
Junction Temperature	T_j	max.	100 °C	100 °C	100 °C
Forward Current $T_s = 25\text{ °C}$	I_F	min.	1 mA	1 mA	1 mA
		max.	30 mA	30 mA	30 mA
Forward Current pulsed $t \leq 100\ \mu\text{s}$; $D = 0.03$; $T_s = 25\text{ °C}$	$I_{F\ pulse}$	max.	100 mA	100 mA	100 mA
Reverse voltage ¹⁾ $T_s = 25\text{ °C}$	V_R	max.	12 V	12 V	12 V
ESD withstand voltage acc. to ANSI/ESDA/JEDEC JS-001 (HBM, Class 1B)	V_{ESD}		500 V	500 V	500 V

Characteristics

$I_F(\bullet \text{ red}) = 20 \text{ mA}$; $I_F(\bullet \text{ true green}) = 20 \text{ mA}$; $I_F(\bullet \text{ blue}) = 10 \text{ mA}$; $T_S = 25 \text{ }^\circ\text{C}$

Parameter	Symbol		Values	Values	Values
			● red	● true green	● blue
Peak Wavelength	λ_{peak}	typ.	630 nm	519 nm	468 nm
Dominant Wavelength ²⁾	λ_{dom}	typ.	623 nm	526 nm	470 nm
Spectral bandwidth at 50% $I_{\text{rel,max}}$	$\Delta\lambda$	typ.	13 nm	25 nm	16 nm
Viewing angle at 50% I_V	2ϕ	typ.	120 °	120 °	120 °
Forward Voltage ³⁾ $I_F = 20 \text{ mA}$	V_F	min.	1.70 V	2.30 V	2.30 V
		typ.	2.10 V	2.70 V	2.70 V
		max.	2.50 V	3.10 V	3.10 V
Reverse current ¹⁾ $V_R = 12 \text{ V}$	I_R	typ.	0.01 μA	0.01 μA	0.01 μA
		max.	10 μA	10 μA	10 μA
Real thermal resistance junction/solderpoint ⁴⁾	$R_{\text{thJS real}}$	typ.	300 K / W	230 K / W	210 K / W
		max.	370 K / W	280 K / W	250 K / W

Rth values valid for one-chip-operation and multi-chip-operation.

Brightness Groups

$I_F(\bullet \text{ red}) = 20 \text{ mA}$; $I_F(\bullet \text{ true green}) = 20 \text{ mA}$; $I_F(\bullet \text{ blue}) = 10 \text{ mA}$

Group	Luminous Intensity ⁵⁾ IF = f(T); all chips on min. I_v	Luminous Intensity ⁵⁾ IF = f(T); all chips on max. I_v
5B	1800 mcd	2010 mcd
6B	2010 mcd	2240 mcd
7B	2240 mcd	2500 mcd
8B	2500 mcd	2800 mcd
5C	2800 mcd	3150 mcd

Chromaticity Coordinate Groups

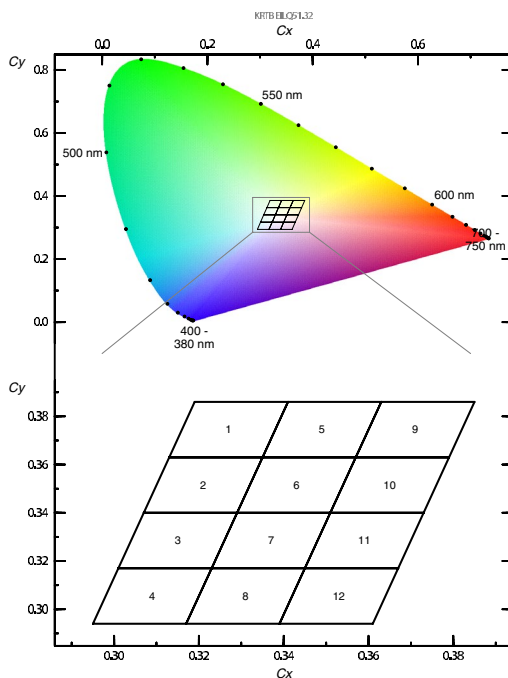

Chromaticity Coordinate Groups

Group	Cx	Cy	Group	Cx	Cy	Group	Cx	Cy
1	0.3190	0.3860	2	0.3130	0.3630	6	0.3350	0.3630
	0.3130	0.3630		0.3070	0.3400		0.3290	0.3400
	0.3350	0.3630		0.3290	0.3400		0.3510	0.3400
	0.3410	0.3860		0.3350	0.3630		0.3570	0.3630
10	0.3570	0.3630	3	0.3070	0.3400	7	0.3290	0.3400
	0.3510	0.3400		0.3010	0.3170		0.3230	0.3170
	0.3730	0.3400		0.3230	0.3170		0.3450	0.3170
	0.3790	0.3630		0.3290	0.3400		0.3510	0.3400
11	0.3510	0.3400	4	0.3010	0.3170	8	0.3230	0.3170
	0.3450	0.3170		0.2950	0.2940		0.3170	0.2940
	0.3670	0.3170		0.3170	0.2940		0.3390	0.2940
	0.3730	0.3400		0.3230	0.3170		0.3450	0.3170
12	0.3450	0.3170	5	0.3410	0.3860	9	0.3630	0.3860
	0.3390	0.2940		0.3350	0.3630		0.3570	0.3630
	0.3610	0.2940		0.3570	0.3630		0.3790	0.3630
	0.3670	0.3170		0.3630	0.3860		0.3850	0.3860

Group Name on Label

Example: 5B-1

Brightness

Color Chromaticity

5B

1

Relative Spectral Emission ⁶⁾

$I_{rel} = f(\lambda)$; $I_F(\bullet \text{ red}) = 20 \text{ mA}$; $I_F(\bullet \text{ true green}) = 20 \text{ mA}$; $I_F(\bullet \text{ blue}) = 10 \text{ mA}$; $T_S = 25 \text{ }^\circ\text{C}$

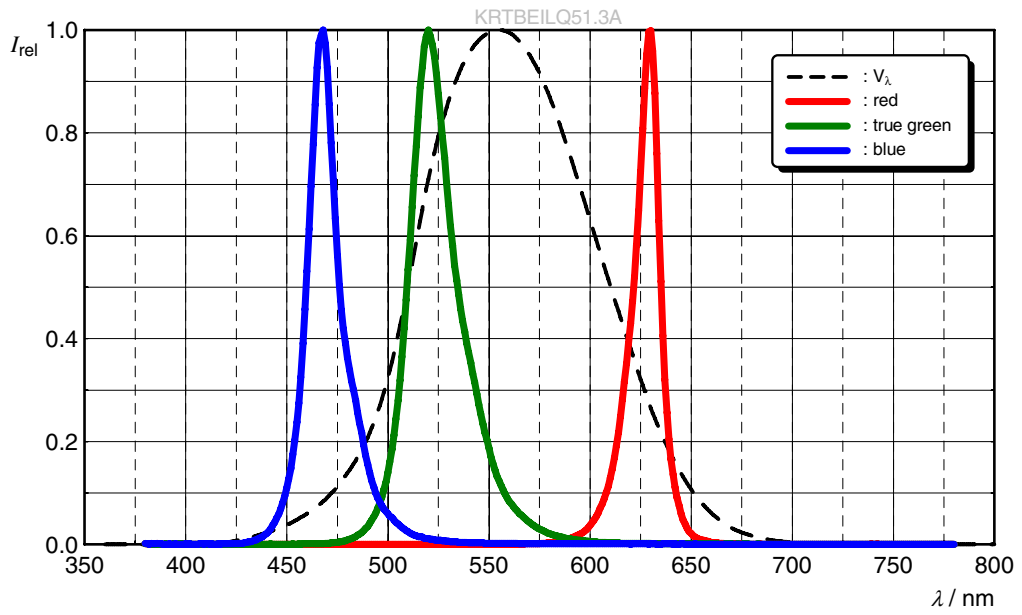

Radiation Characteristic (horizontal) ⁶⁾

$I_{rel} = f(\phi); T_S = 25\text{ }^\circ\text{C}$

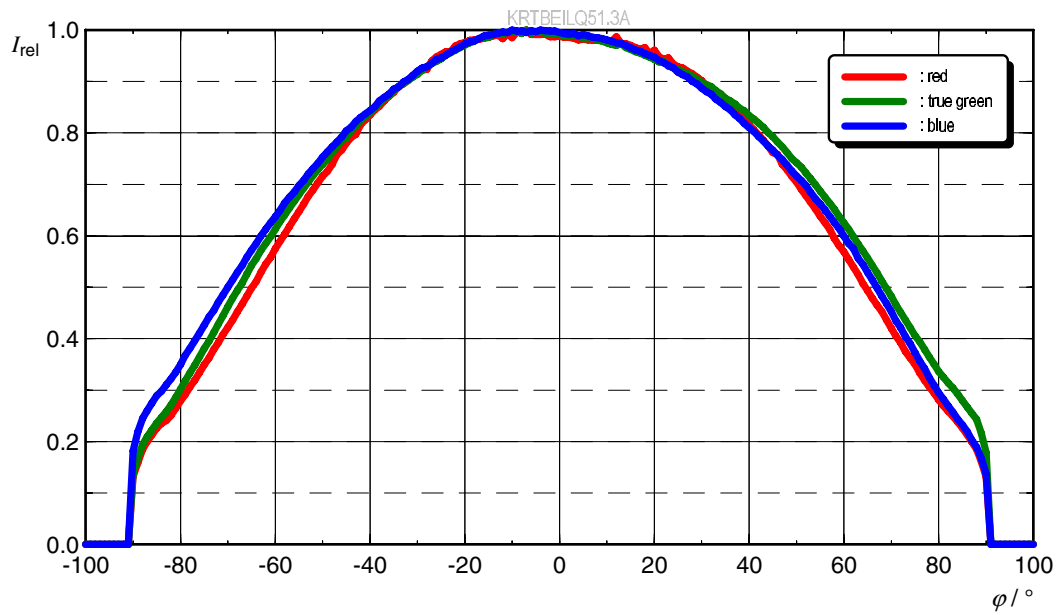

Radiation Characteristic (vertical) ⁶⁾

$I_{rel} = f(\phi); T_S = 25\text{ }^\circ\text{C}$

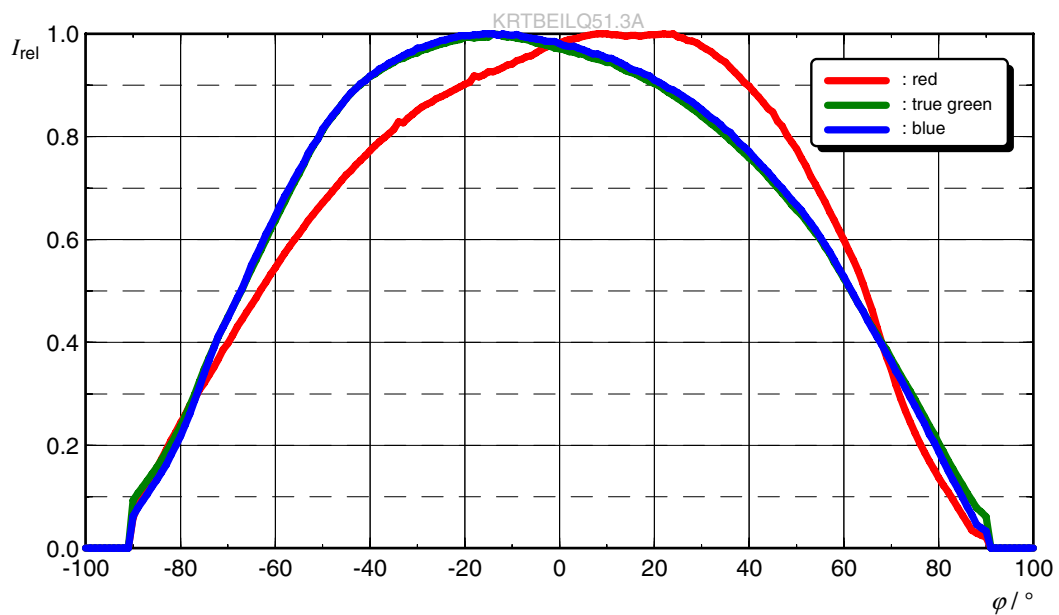

Forward current ⁶⁾

$I_F = f(V_F); T_S = 25\text{ °C}$

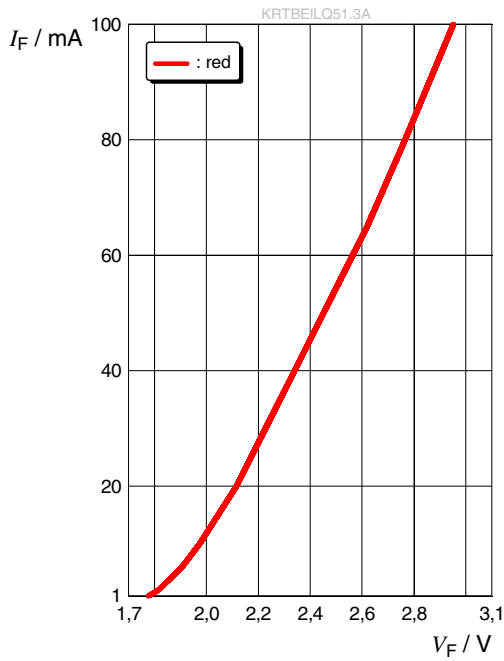

Forward current ⁶⁾

$I_F = f(V_F); T_S = 25\text{ °C}$

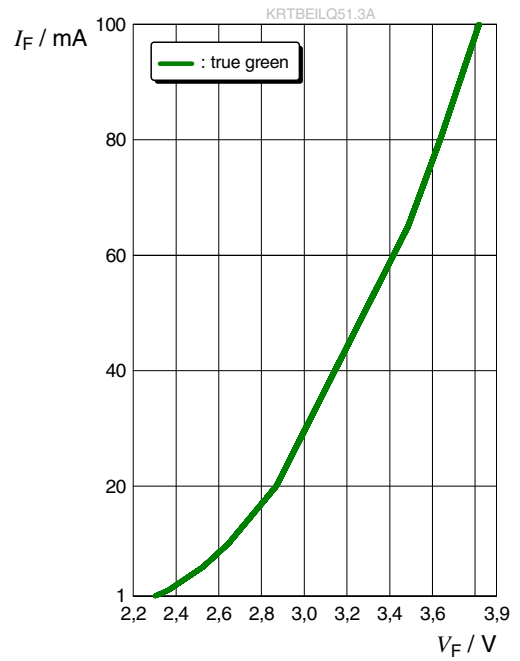

Forward current ⁶⁾

$I_F = f(V_F); T_S = 25\text{ °C}$

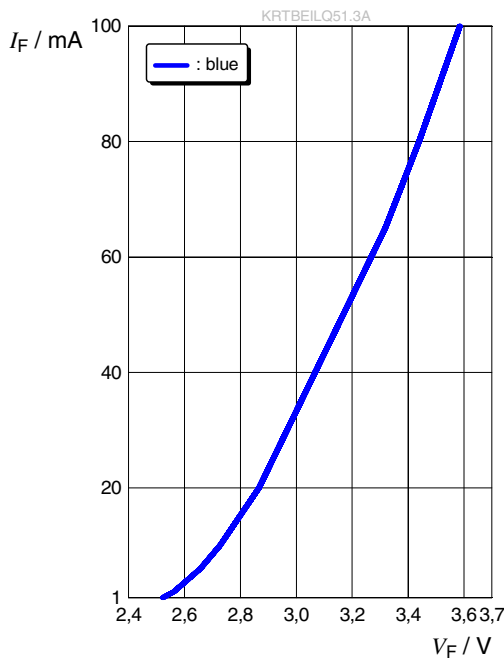

Relative Luminous Intensity ^{6), 7)}

$I_V/I_V(20\text{ mA}) = f(I_F); T_S = 25\text{ °C}$

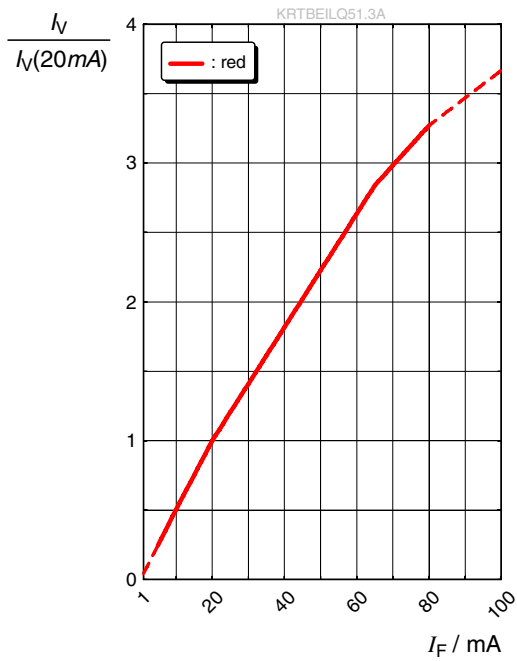

Relative Luminous Intensity ^{6), 7)}

$I_V/I_V(20\text{ mA}) = f(I_F); T_S = 25\text{ °C}$

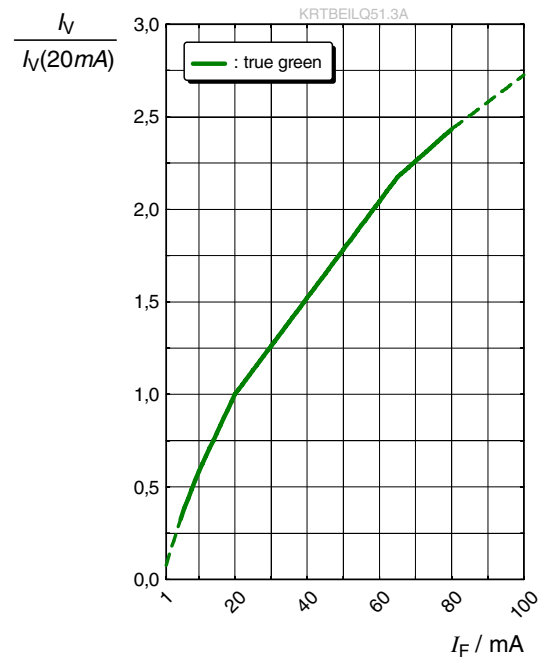

Relative Luminous Intensity ^{6), 7)}

$I_V/I_V(10\text{ mA}) = f(I_F); T_S = 25\text{ °C}$

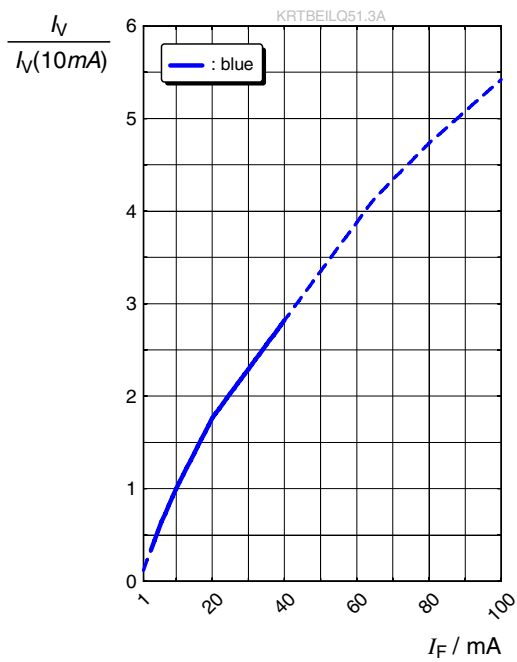

Dominant Wavelength ⁶⁾

$$\lambda_{\text{dom}} = f(I_F); T_S = 25 \text{ }^\circ\text{C}$$

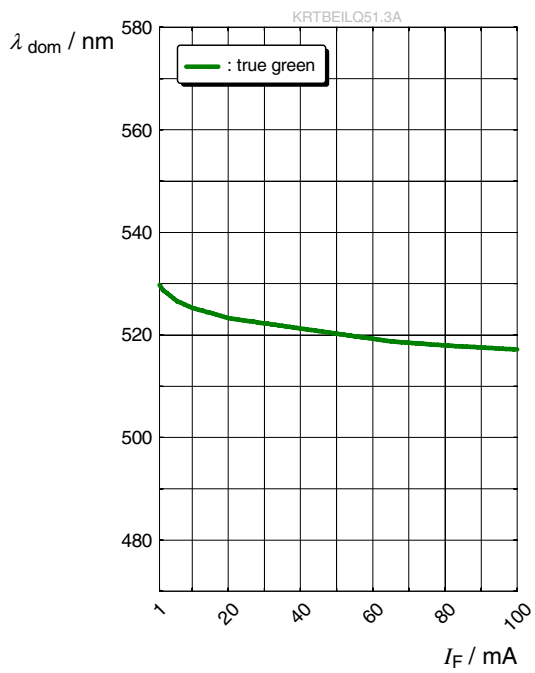

Dominant Wavelength ⁶⁾

$$\lambda_{\text{dom}} = f(I_F); T_S = 25 \text{ }^\circ\text{C}$$

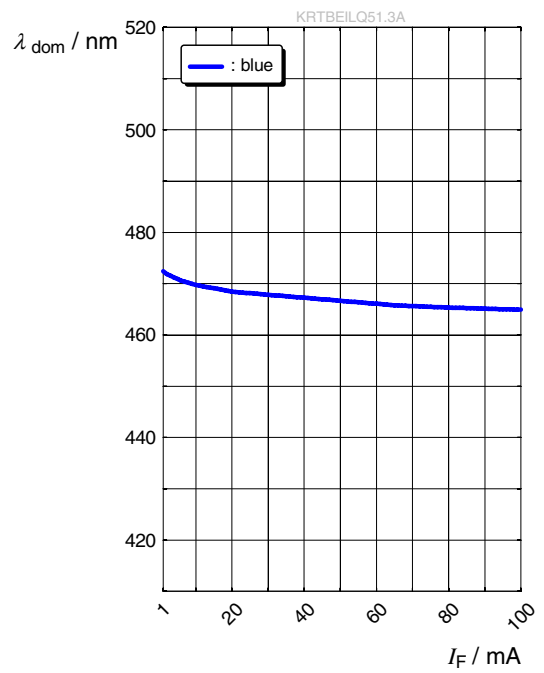

Forward Voltage ⁶⁾

$$\Delta V_F = V_F - V_F(25\text{ °C}) = f(T_j); I_F = 20\text{ mA}$$

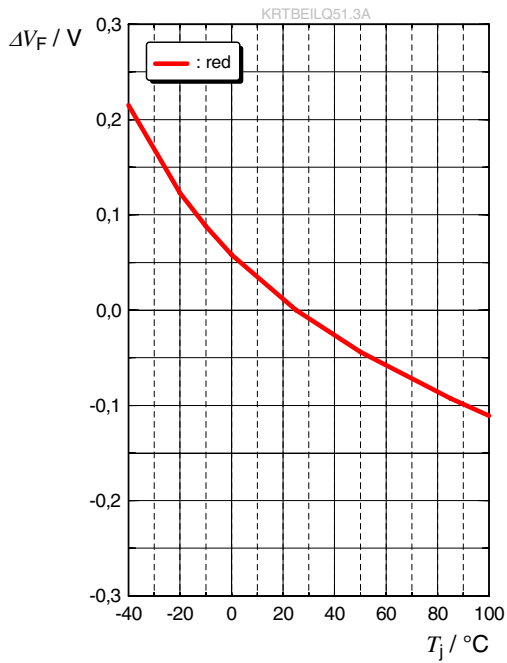

Forward Voltage ⁶⁾

$$\Delta V_F = V_F - V_F(25\text{ °C}) = f(T_j); I_F = 20\text{ mA}$$

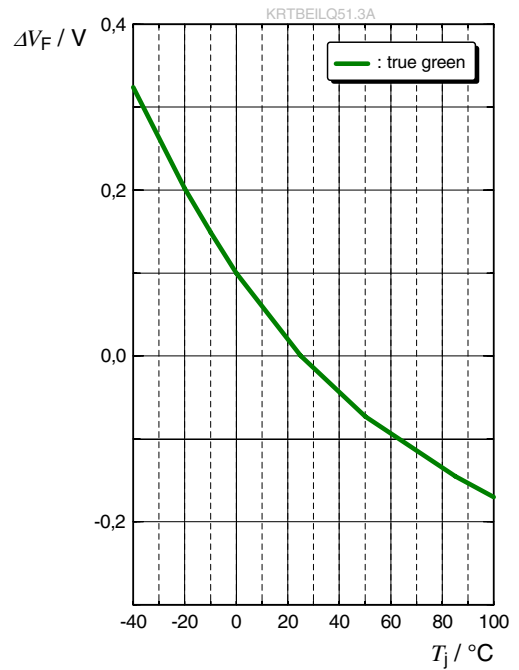

Forward Voltage ⁶⁾

$$\Delta V_F = V_F - V_F(25\text{ °C}) = f(T_j); I_F = 10\text{ mA}$$

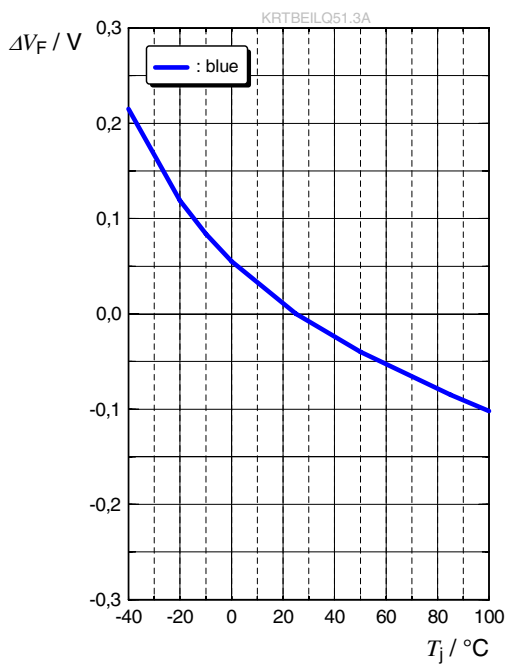

Relative Luminous Intensity ⁶⁾

$$I_V/I_V(25\text{ °C}) = f(T_j); I_F = 20\text{ mA}$$

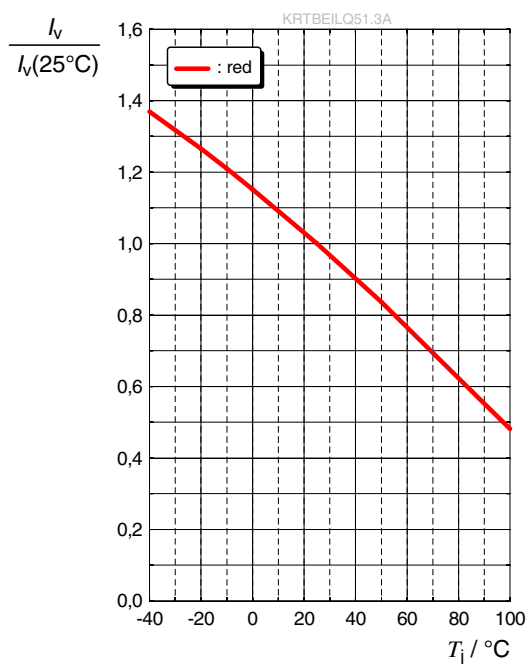

Relative Luminous Intensity ⁶⁾

$$I_V/I_V(25\text{ °C}) = f(T_j); I_F = 20\text{ mA}$$

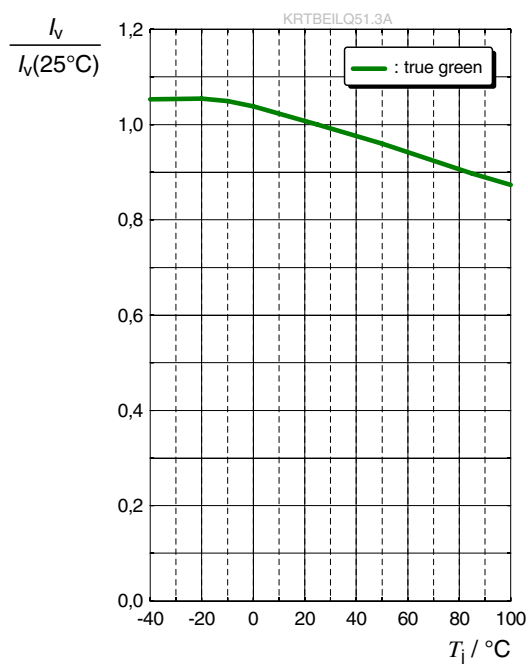

Relative Luminous Intensity ⁶⁾

$$I_V/I_V(25\text{ °C}) = f(T_j); I_F = 10\text{ mA}$$

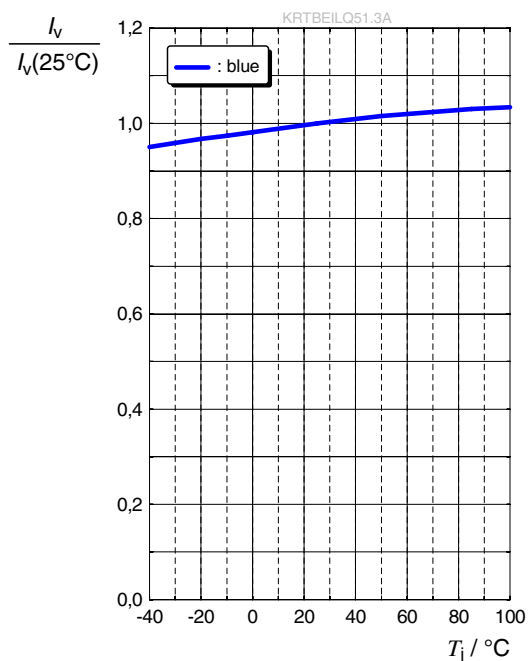

Dominant Wavelength ⁶⁾

$$\Delta\lambda_{\text{dom}} = \lambda_{\text{dom}} - \lambda_{\text{dom}}(25\text{ °C}) = f(T_j); I_F = 20\text{ mA}$$

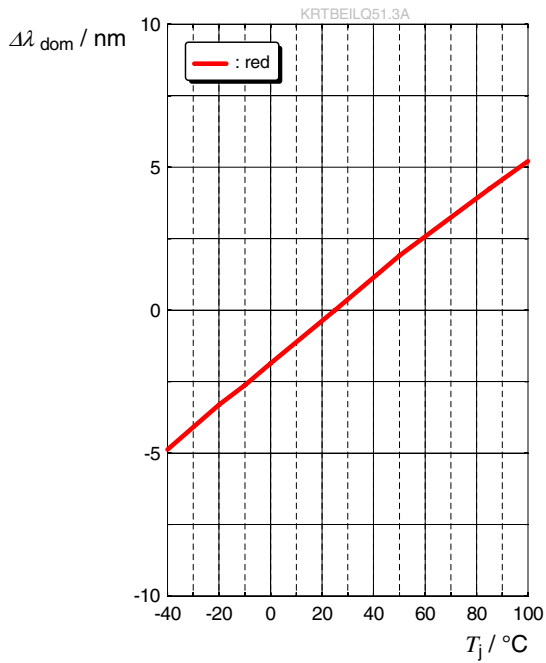

Dominant Wavelength ⁶⁾

$$\Delta\lambda_{\text{dom}} = \lambda_{\text{dom}} - \lambda_{\text{dom}}(25\text{ °C}) = f(T_j); I_F = 20\text{ mA}$$

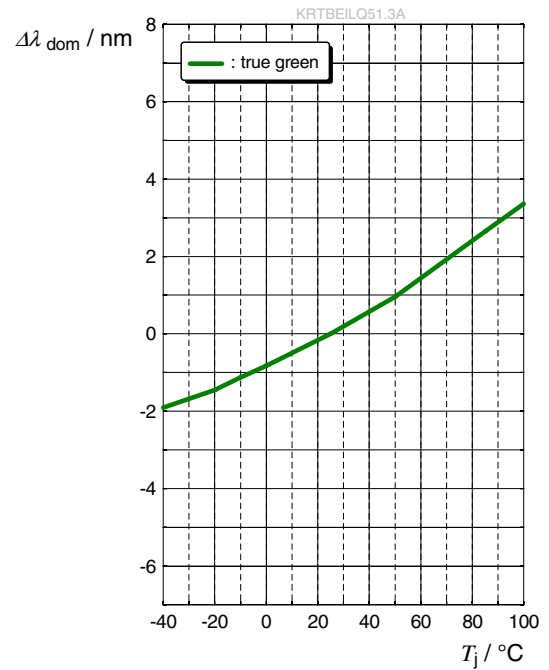

Dominant Wavelength ⁶⁾

$$\Delta\lambda_{\text{dom}} = \lambda_{\text{dom}} - \lambda_{\text{dom}}(25\text{ °C}) = f(T_j); I_F = 10\text{ mA}$$

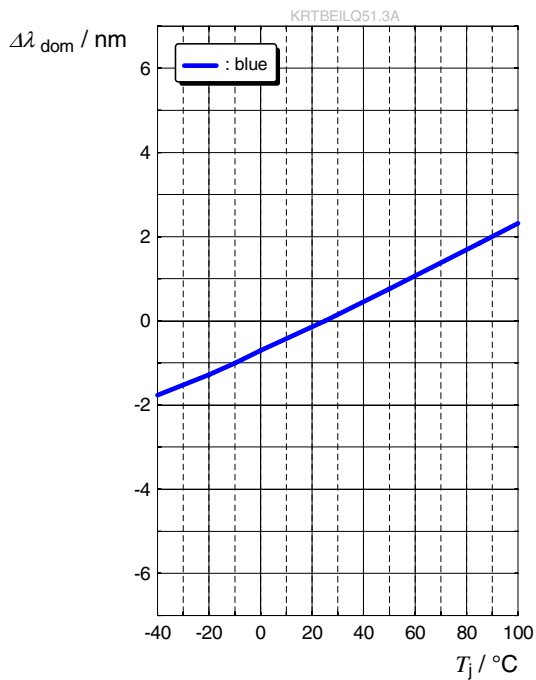

Max. Permissible Forward Current

$I_F = f(T)$; ● red

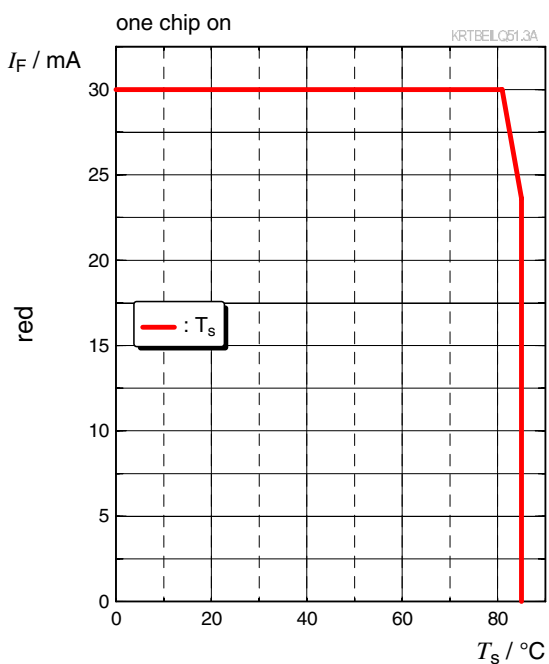

Max. Permissible Forward Current

$I_F = f(T)$; ● true green

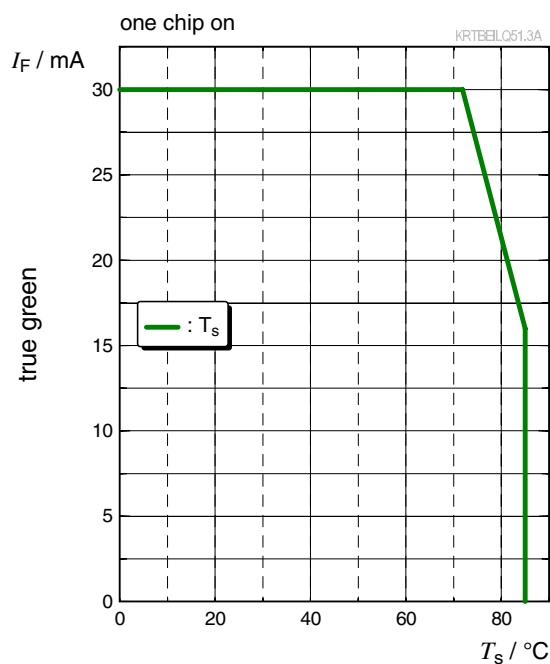

Max. Permissible Forward Current

$I_F = f(T)$; ● blue

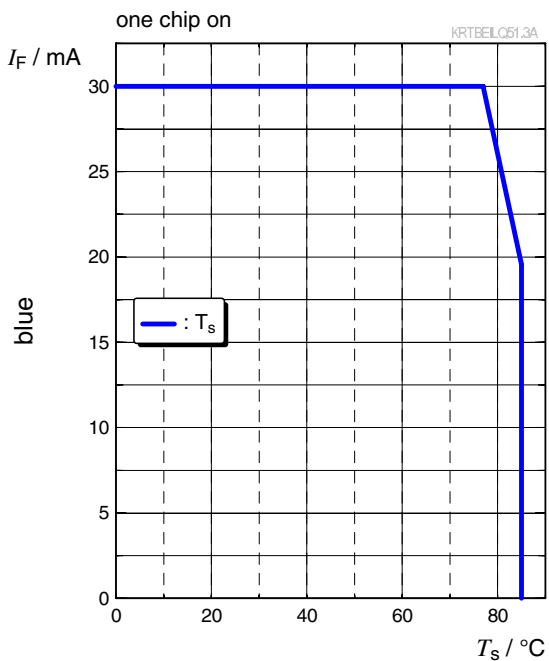

Max. Permissible Forward Current

$I_F = f(T)$; all chips on

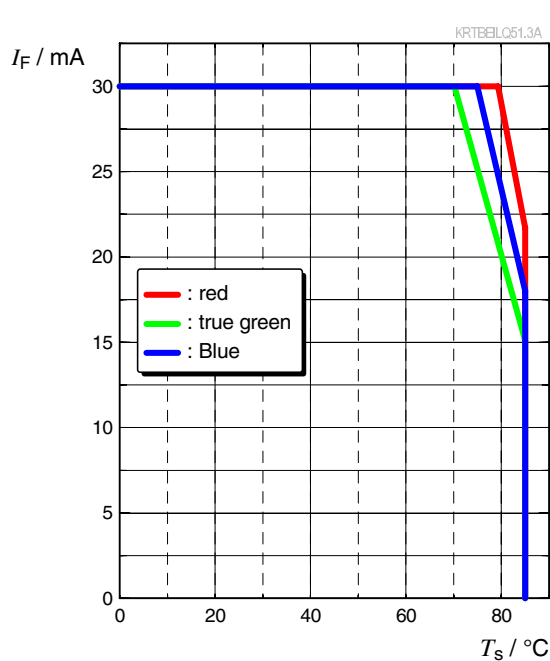

Permissible Pulse Handling Capability

$I_F = f(t_p)$; D: Duty cycle; ● red

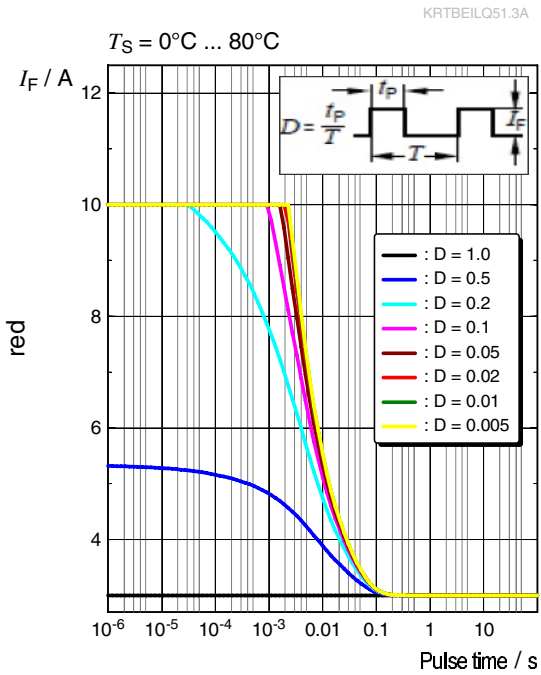

Permissible Pulse Handling Capability

$I_F = f(t_p)$; D: Duty cycle; ● red

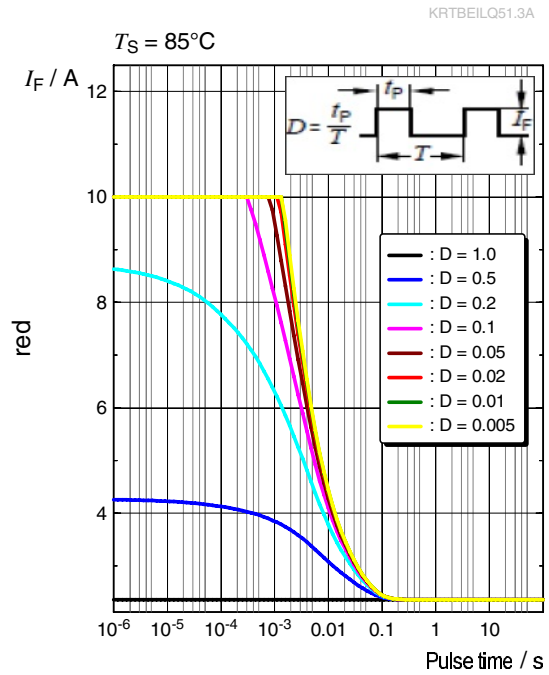

Permissible Pulse Handling Capability

$I_F = f(t_p)$; D: Duty cycle; ● true green

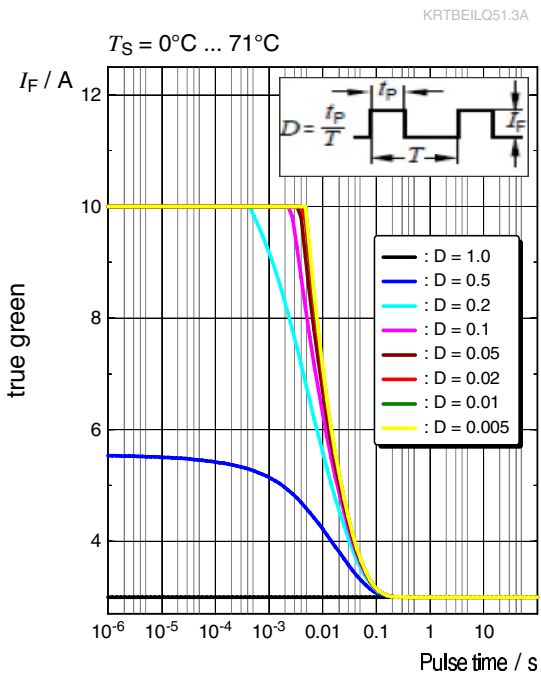

Permissible Pulse Handling Capability

$I_F = f(t_p)$; D: Duty cycle; ● true green

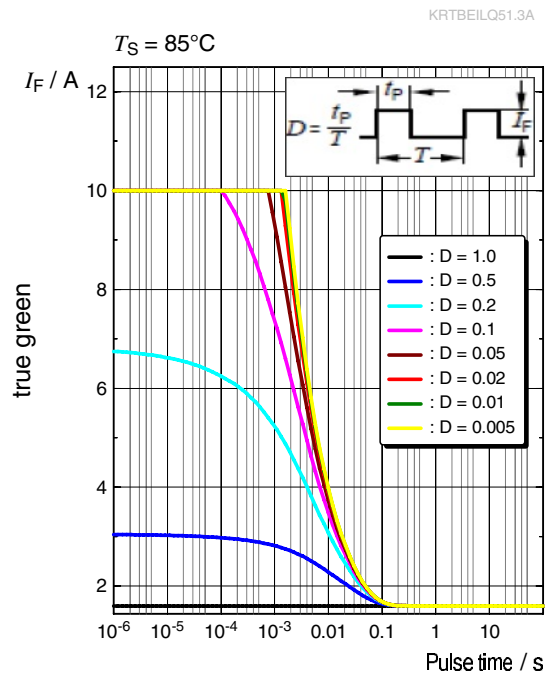

Permissible Pulse Handling Capability

$I_F = f(t_p)$; D: Duty cycle; • blue

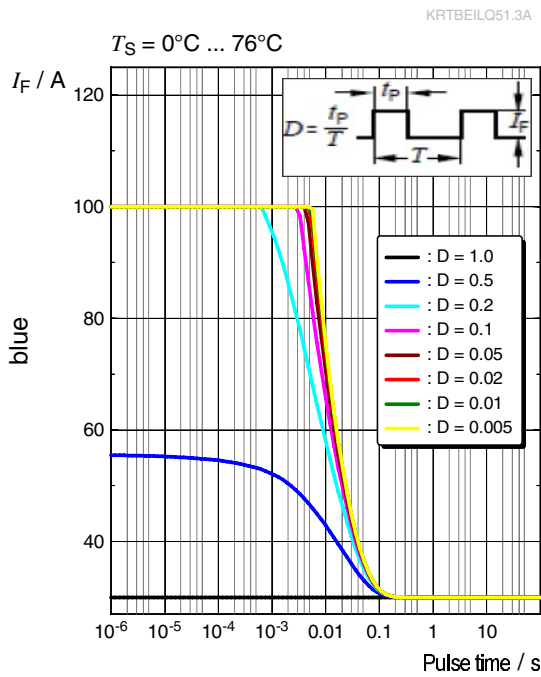

Permissible Pulse Handling Capability

$I_F = f(t_p)$; D: Duty cycle; • blue

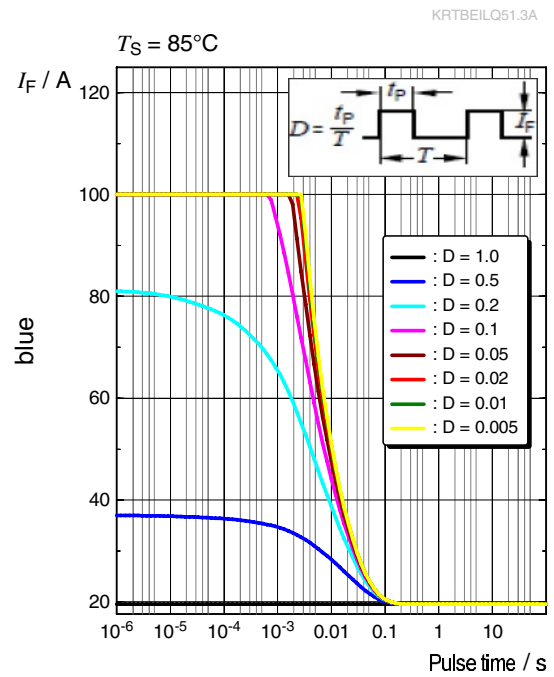

Dimensional Drawing ⁸⁾

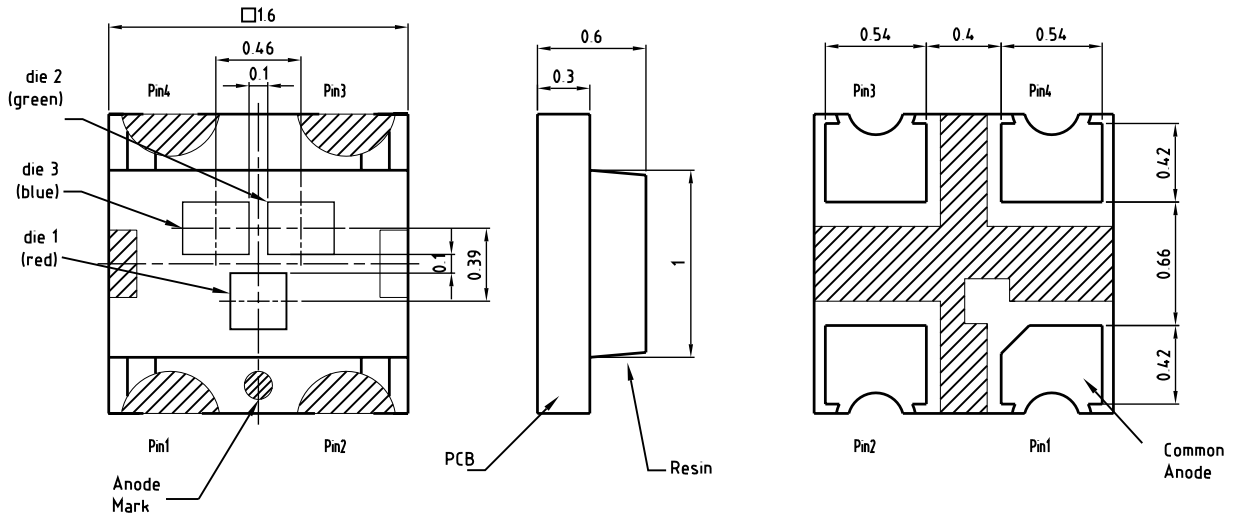

general tolerance ± 0.1
lead finish Au

C63062-A4403-A1-01

Further Information:

Approximate Weight: 2.4 mg

Package marking: Anode

Electrical Internal Circuit

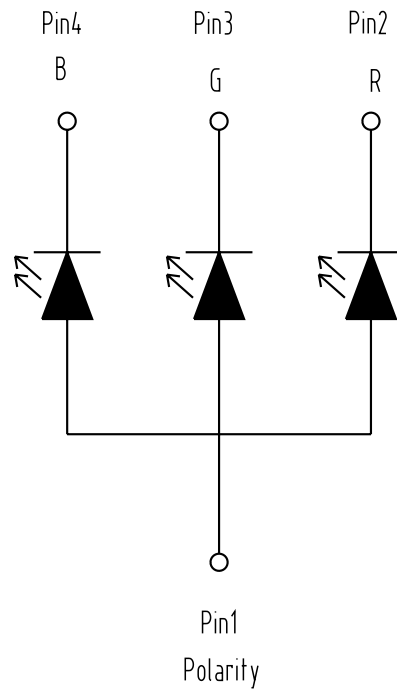

Recommended Solder Pad ⁸⁾

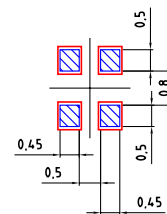
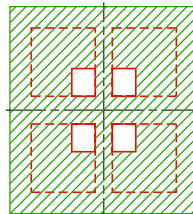
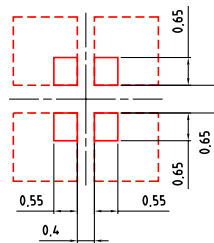

Component Location on Pad

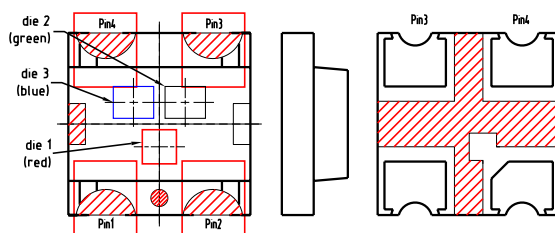

E062.3010.275-01

For superior solder joint connectivity results we recommend soldering under standard nitrogen atmosphere. Package not suitable for any kind of wet cleaning or ultrasonic cleaning.

Reflow Soldering Profile

Product complies to MSL Level 3 acc. to JEDEC J-STD-020E

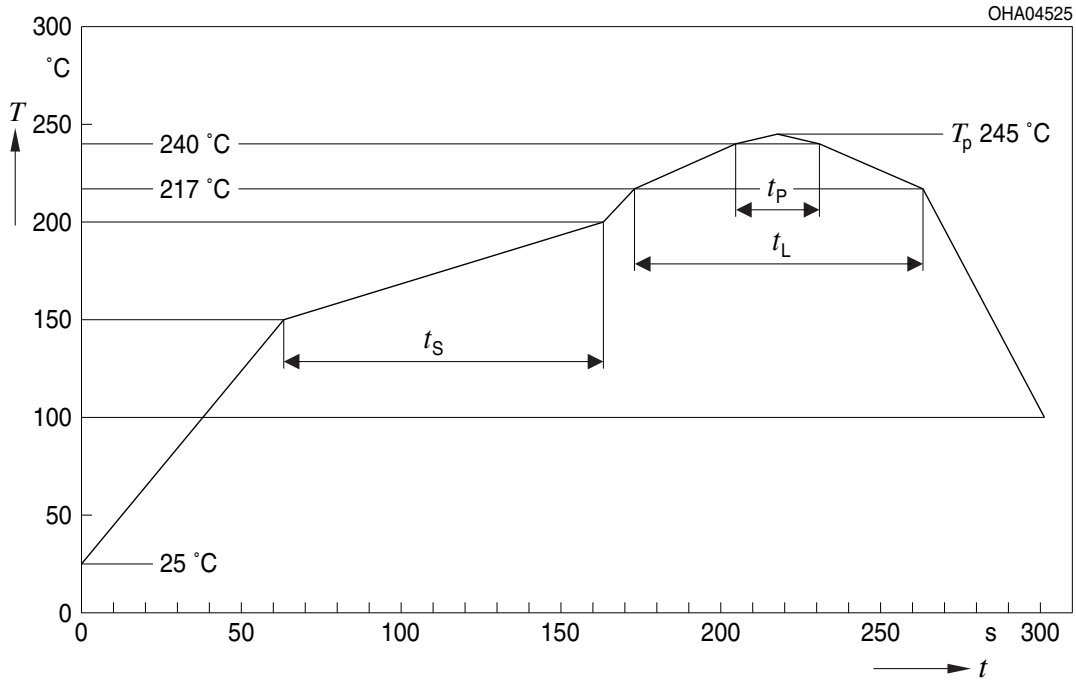

Profile Feature	Symbol	Pb-Free (SnAgCu) Assembly			Unit
		Minimum	Recommendation	Maximum	
Ramp-up rate to preheat ^{*)} 25 °C to 150 °C			2	3	K/s
Time t_s T_{Smin} to T_{Smax}	t_s	60	100	120	s
Ramp-up rate to peak ^{*)} T_{Smax} to T_p			2	3	K/s
Liquidus temperature	T_L		217		°C
Time above liquidus temperature	t_L		80	100	s
Peak temperature	T_p		245	260	°C
Time within 5 °C of the specified peak temperature $T_p - 5$ K	t_p	10	20	30	s
Ramp-down rate* T_p to 100 °C			3	6	K/s
Time 25 °C to T_p				480	s

All temperatures refer to the center of the package, measured on the top of the component
^{*)} slope calculation DT/Dt : Dt max. 5 s; fulfillment for the whole T-range

Tape and Reel ⁹⁾

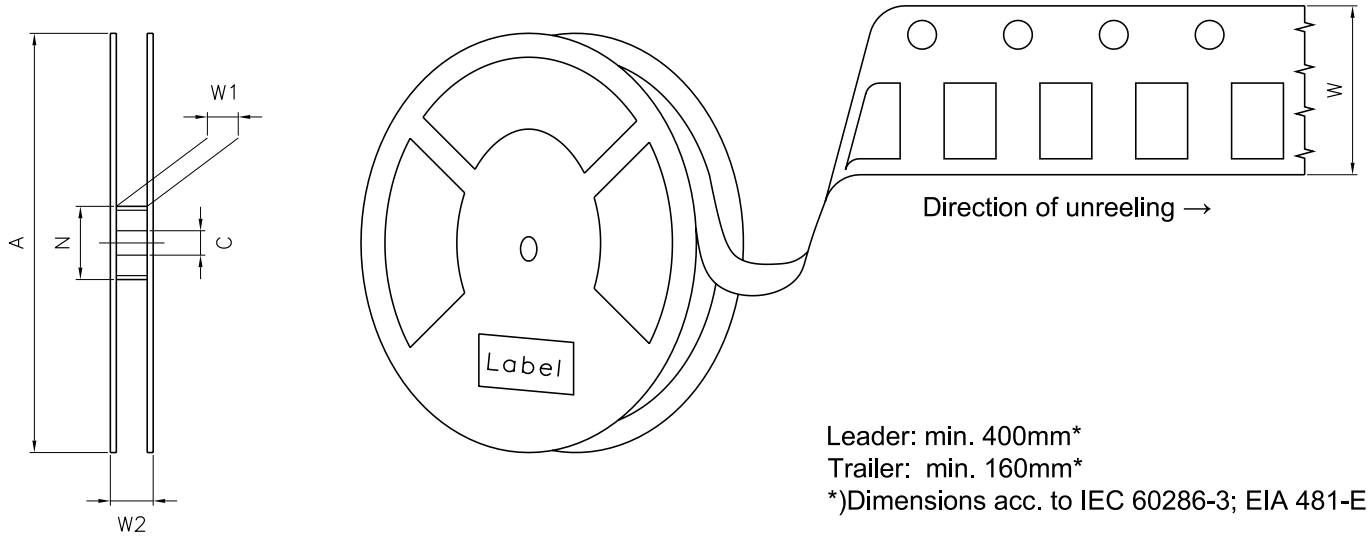

Reel Dimensions

A	W	N _{min}	W ₁	W _{2 max}	Pieces per PU
180 mm	8 + 0.3 / - 0.1 mm	60 mm	8.4 + 2 mm	14.4 mm	3000

Barcode-Product-Label (BPL)

OSRAM Opto Semiconductors LX XXXX BIN1: XX-XX-X-XXX-X

RoHS Compliant

(6P) BATCH NO: 1234567890

(1T) LOT NO: 1234567890 (9D) D/C: 1234

(X) PROD NO: 123456789(Q)QTY: 9999 (G) GROUP: XX-XX-X-X

ML Temp ST
X XXX °C X

Pack: RXX
DEMY XXX
X_X123_1234.1234 X

OHA04563

Dry Packing Process and Materials ⁸⁾

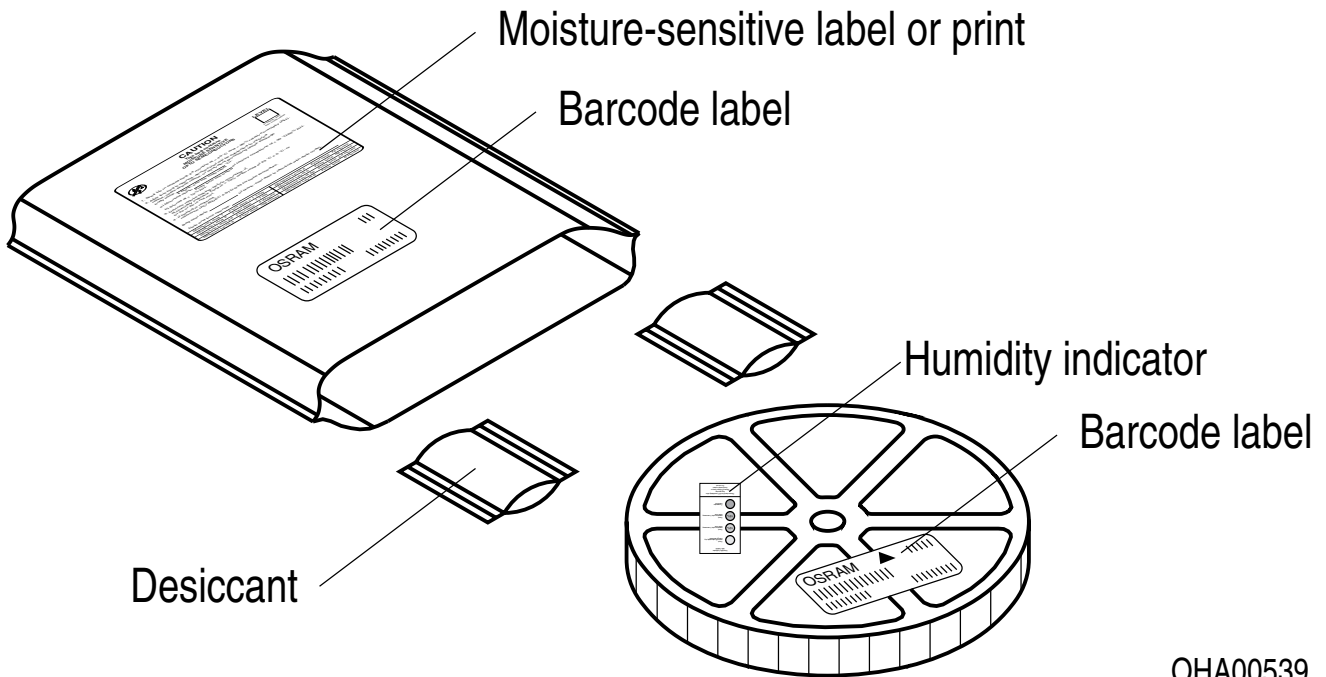

OHA00539

Moisture-sensitive product is packed in a dry bag containing desiccant and a humidity card according JEDEC-STD-033.

Notes

The evaluation of eye safety occurs according to the standard IEC 62471:2006 (photo biological safety of lamps and lamp systems). Within the risk grouping system of this IEC standard, the device specified in this data sheet fall into the class **exempt group (exposure time 10000 s)**. Under real circumstances (for exposure time, conditions of the eye pupils, observation distance), it is assumed that no endangerment to the eye exists from these devices. As a matter of principle, however, it should be mentioned that intense light sources have a high secondary exposure potential due to their blinding effect. When looking at bright light sources (e.g. headlights), temporary reduction in visual acuity and afterimages can occur, leading to irritation, annoyance, visual impairment, and even accidents, depending on the situation.

Subcomponents of this device contain, in addition to other substances, metal filled materials including silver. Metal filled materials can be affected by environments that contain traces of aggressive substances. Therefore, we recommend that customers minimize device exposure to aggressive substances during storage, production, and use. Devices that showed visible discoloration when tested using the described tests above did show no performance deviations within failure limits during the stated test duration. Respective failure limits are described in the IEC60810.

For further application related information please visit www.osram-os.com/appnotes

Disclaimer

Attention please!

The information describes the type of component and shall not be considered as assured characteristics. Terms of delivery and rights to change design reserved. Due to technical requirements components may contain dangerous substances.

For information on the types in question please contact our Sales Organization.

If printed or downloaded, please find the latest version on our website.

Packing

Please use the recycling operators known to you. We can also help you – get in touch with your nearest sales office. By agreement we will take packing material back, if it is sorted. You must bear the costs of transport. For packing material that is returned to us unsorted or which we are not obliged to accept, we shall have to invoice you for any costs incurred.

Product and functional safety devices/applications or medical devices/applications

Our components are not developed, constructed or tested for the application as safety relevant component or for the application in medical devices.

Our products are not qualified at module and system level for such application.

In case buyer – or customer supplied by buyer – considers using our components in product safety devices/ applications or medical devices/applications, buyer and/or customer has to inform our local sales partner immediately and we and buyer and /or customer will analyze and coordinate the customer-specific request between us and buyer and/or customer.

Glossary

- 1) **Reverse Operation:** This product is intended to be operated applying a forward current within the specified range. Applying any continuous reverse bias or forward bias below the voltage range of light emission shall be avoided because it may cause migration which can change the electro-optical characteristics or damage the LED.
- 2) **Wavelength:** Wavelengths are tested at a current pulse duration of 25 ms and a tolerance of ± 1 nm.
- 3) **Forward Voltage:** Forward voltages are tested at a current pulse duration of 1 ms and a tolerance of ± 0.1 V.
- 4) **Thermal Resistance:** $R_{th\ max}$ is based on statistic values (6σ).
- 5) **Brightness:** Brightness groups are tested at a current pulse duration of 25 ms and a tolerance of ± 11 %.
- 6) **Typical Values:** Due to the special conditions of the manufacturing processes of semiconductor devices, the typical data or calculated correlations of technical parameters can only reflect statistical figures. These do not necessarily correspond to the actual parameters of each single product, which could differ from the typical data and calculated correlations or the typical characteristic line. If requested, e.g. because of technical improvements, these typ. data will be changed without any further notice.
- 7) **Characteristic curve:** In the range where the line of the graph is broken, you must expect higher differences between single devices within one packing unit.
- 8) **Tolerance of Measure:** Unless otherwise noted in drawing, tolerances are specified with ± 0.1 and dimensions are specified in mm.
- 9) **Tape and Reel:** All dimensions and tolerances are specified acc. IEC 60286-3 and specified in mm.

Revision History

Version	Date	Change
1.0	2019-10-17	Initial Version
1.1	2020-08-19	Schematic Transportation Box Dimensions of Transportation Box
1.2	2020-10-12	Characteristics Derating (Diagrams) Reflow Soldering Profile
1.3	2022-11-25	Brand New Layout Applications



EU RoHS and China RoHS compliant product

此产品符合欧盟 RoHS 指令的要求；
按照中国的相关法规和标准，
不含有毒有害物质或元素。

Published by ams-OSRAM AG

Tobelbader Strasse 30, 8141 Premstaetten, Austria

Phone +43 3136 500-0

ams-osram.com

© All rights reserved

am 

OSRAM