

# IRFR220, IRFR221, IRFR222, IRFU220, IRFU221, IRFU222

3.8A and 4.6A, 150V and 200V, 0.8 and 1.2 Ohm,  
N-Channel Power MOSFETs

January 1998

## Features

- 3.8A and 4.6A, 150V and 200V
- $r_{DS(ON)} = 0.8\Omega$  and  $1.2\Omega$
- Single Pulse Avalanche Energy Rated
- SOA is Power Dissipation Limited
- Nanosecond Switching Speeds
- Linear Transfer Characteristics
- High Input Impedance
- Related Literature
  - TB334 "Guidelines for Soldering Surface Mount Components to PC Boards"

## Ordering Information

PART NUMBER	PACKAGE	BRAND
IRFR220	TO-252AA	IFR220
IRFR221	TO-252AA	IFR221
IRFR222	TO-252AA	IFR222
IRFU220	TO-251AA	IFU220
IRFU221	TO-251AA	IFU221
IRFU222	TO-251AA	IFU222

NOTE: When ordering, use the entire part number.

## Description

These are N-Channel enhancement mode silicon gate power field effect transistors. They are advanced power MOSFETs designed, tested, and guaranteed to withstand a specified level of energy in the breakdown avalanche mode of operation. All of these power MOSFETs are designed for applications such as switching regulators, switching converters, motor drivers, relay drivers, and drivers for high power bipolar switching transistors requiring high speed and low gate drive power. These types can be operated directly from integrated circuits.

Formerly developmental type TA9600.

## Symbol

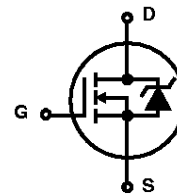

## Packaging

JEDEC TO-251 AA

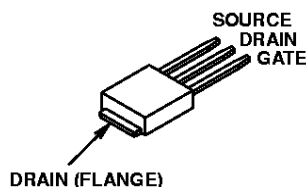

JEDEC TO-252AA

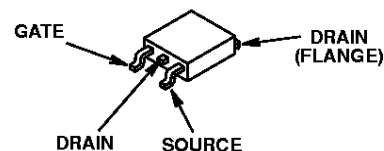

## IRFR220, IRFR221, IRFR222, IRFU220, IRFU221, IRFU222

### Absolute Maximum Ratings $T_C = 25^\circ\text{C}$ , Unless Otherwise Specified

	IRFR220 IRFU220	IRFR221 IRFU221	IRFR222 IRFU222	UNITS	
Drain to Source Voltage (Note 1) . . . . .	$V_{DS}$	200	150	200	V
Drain to Gate Voltage ( $R_{GS} = 20\text{k}\Omega$ ) (Note 1) . . . . .	$V_{DGR}$	200	150	200	V
Continuous Drain Current (Note 3) . . . . .	$I_D$	4.6	4.6	3.8	A
$T_C = 100^\circ\text{C}$ . . . . .	$I_D$	2.9	2.9	2.4	A
Pulsed Drain Current . . . . .	$I_{DM}$	18	18	15	A
Gate to Source Voltage . . . . .	$V_{GS}$	$\pm 20$	$\pm 20$	$\pm 20$	V
Maximum Power Dissipation . . . . .	$P_D$	50	50	50	W
Linear Derating Factor . . . . .		0.4	0.4	0.4	$\text{W}/^\circ\text{C}$
Single Pulse Avalanche Energy Rating (Note 4) . . . . .	$E_{AS}$	85	85	85	mJ
Operating and Storage Temperature . . . . .	$T_J, T_{STG}$	-55 to 150	-55 to 150	-55 to 150	$^\circ\text{C}$
Maximum Temperature for Soldering					
Leads at 0.063in (1.6mm) from Case for 10s . . . . .	$T_L$	300	300	300	$^\circ\text{C}$
Package Body for 10s, See Techbrief 334 . . . . .	$T_{pk}$	260	260	260	$^\circ\text{C}$

**CAUTION:** Stresses above those listed in "Absolute Maximum Ratings" may cause permanent damage to the device. This is a stress only rating and operation of the device at these or any other conditions above those indicated in the operational sections of this specification is not implied.

**NOTE:**

- $T_J = 25^\circ\text{C}$  to  $125^\circ\text{C}$ .

### Electrical Specifications $T_C = 25^\circ\text{C}$ , Unless Otherwise Specified

PARAMETER	SYMBOL	TEST CONDITIONS	MIN	TYP	MAX	UNITS
Drain to Source Breakdown Voltage IRFR220, IRFU220 IRFR221, IRFU221 IRFR222, IRFU222	$BV_{DSS}$	$I_D = 250\mu\text{A}, V_{GS} = 0\text{V}$ , (Figure 10)	200	-	-	V
			150	-	-	V
			200	-	-	V
Gate Threshold Voltage	$V_{GS(TH)}$	$V_{GS} = V_{DS}, I_D = 250\mu\text{A}$	2.0	-	4.0	V
Zero Gate Voltage Drain Current	$I_{DSS}$	$V_{DS} = \text{Rated } BV_{DSS}, V_{GS} = 0\text{V}$	-	-	25	$\mu\text{A}$
		$V_{DS} = 0.8 \times \text{Rated } BV_{DSS}, V_{GS} = 0\text{V}, T_J = 125^\circ\text{C}$	-	-	250	$\mu\text{A}$
On-State Drain Current (Note 2) IRFR220, IRFU220 IRFR221, IRFU221 IRFR222, IRFU222	$I_{D(ON)}$	$V_{DS} > I_{D(ON)} \times r_{DS(ON)MAX}, V_{GS} = 10\text{V}$ , (Figure 7)	4.6	-	-	A
			4.6	-	-	A
			3.8	-	-	A
Gate to Source Leakage Current	$I_{GSS}$	$V_{GS} = \pm 20\text{V}$	-	-	$\pm 100$	nA
Drain to Source On Resistance (Note 2) IRFR220, IRFU220 IRFR221, IRFU221 IRFR222, IRFU222	$r_{DS(ON)}$	$I_D = 2.4\text{A}, V_{GS} = 10\text{V}$ , (Figures 8, 9)	-	0.47	0.80	$\Omega$
			-	0.47	0.80	$\Omega$
			-	0.80	1.2	$\Omega$
Forward Transconductance (Note 2)	$g_{fs}$	$V_{DS} \geq 50\text{V}, I_D = 2.4\text{A}$ , (Figure 12)	1.7	2.6	-	S
Turn-On Delay Time	$t_{d(ON)}$	$V_{DD} = 100\text{V}, I_D \approx 4.6\text{A}, R_G = 18\Omega, R_L = 18\Omega,$ $V_{GS} = 10\text{V}$ , (Figures 17, 18) MOSFET Switching Times are Essentially Independent of Operating Temperature	-	8.8	13	ns
Rise Time	$t_r$		-	27	41	ns
Turn-Off Delay Time	$t_{d(OFF)}$		-	21	32	ns
Fall Time	$t_f$		-	14	21	ns

## IRFR220, IRFR221, IRFR222, IRFU220, IRFU221, IRFU222

### Electrical Specifications $T_C = 25^\circ\text{C}$ , Unless Otherwise Specified (Continued)

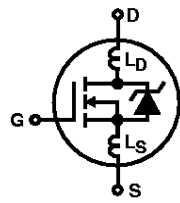
PARAMETER	SYMBOL	TEST CONDITIONS		MIN	TYP	MAX	UNITS
Total Gate Charge (Gate to Source + Gate to Drain)	$Q_{g(\text{TOT})}$	$V_{GS} = 10\text{V}$ , $I_D = 4.6\text{A}$ , $V_{DS} = 0.8 \times \text{Rated } BV_{DSS}$ , $I_{G(\text{REF})} = 1.5\text{mA}$ , (Figures 14, 19, 20) Gate Charge is Essentially Independent of Operating Temperature		-	12	18	nC
Gate to Source Charge	$Q_{gs}$			-	2.3	3.4	nC
Gate to Drain "Miller" Charge	$Q_{gd}$			-	4.5	6.8	nC
Input Capacitance	$C_{ISS}$	$V_{DS} = 25\text{V}$ , $V_{GS} = 0\text{V}$ , $f = 1\text{MHz}$ , (Figure 11)		-	330	-	pF
Output Capacitance	$C_{OSS}$			-	120	-	pF
Reverse Transfer Capacitance	$C_{RSS}$			-	41	-	pF
Internal Drain Inductance	$L_D$	Measured From the Drain Lead, 6.0mm (0.25in) From Package to Center of Die	Modified MOSFET Symbol Showing the Internal Device Inductances 	-	4.5	-	nH
Internal Source Inductance	$L_S$	Measured From the Source Lead, 6.0mm (0.25in) From Package to Source Bonding Pad		-	7.5	-	nH
Thermal Resistance, Junction to Case	$R_{\theta JC}$			-	-	2.5	$^\circ\text{C/W}$
Thermal Resistance, Junction to Ambient	$R_{\theta JA}$	Typical Solder Mount		-	-	110	$^\circ\text{C/W}$

### Source to Drain Diode Specifications

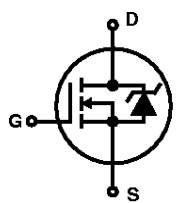
PARAMETER	SYMBOL	TEST CONDITIONS		MIN	TYP	MAX	UNITS
Continuous Source to Drain Current	$I_{SD}$	Modified MOSFET Symbol Showing the Integral Reverse P-N Junction Rectifier 		-	-	4.6	A
Pulse Source to Drain Current (Note 3)	$I_{SDM}$			-	-	18	A
Source to Drain Diode Voltage (Note 2)	$V_{SD}$	$T_J = 25^\circ\text{C}$ , $I_{SD} = 4.6\text{A}$ , $V_{GS} = 0\text{V}$ , (Figure 13)		-	-	1.8	V
Reverse Recovery Time	$t_{rr}$	$T_J = 25^\circ\text{C}$ , $I_{SD} = 4.6\text{A}$ , $dI_{SD}/dt = 100\text{A}/\mu\text{s}$		69	170	400	ns
Reverse Recovery Charge	$Q_{RR}$	$T_J = 25^\circ\text{C}$ , $I_{SD} = 4.6\text{A}$ , $dI_{SD}/dt = 100\text{A}/\mu\text{s}$		0.30	0.72	1.8	$\mu\text{C}$

#### NOTES:

2.  $T_J = 25^\circ\text{C}$  to  $150^\circ\text{C}$ .
3. Pulse test: pulse width  $\leq 300\mu\text{s}$ , duty cycle  $\leq 2\%$ .
4. Repetitive rating: pulse width limited by maximum junction temperature. See Transient Thermal Impedance curve (Figure 3).
5.  $V_{DD} = 10\text{V}$ , starting  $T_J = 25^\circ\text{C}$ ,  $L = 6.18\text{mH}$ ,  $R_G = 50\Omega$ , peak  $I_{AS} = 4.6\text{A}$ .

# IRFR220, IRFR221, IRFR222, IRFU220, IRFU221, IRFU222

## Typical Performance Curves Unless Otherwise Specified

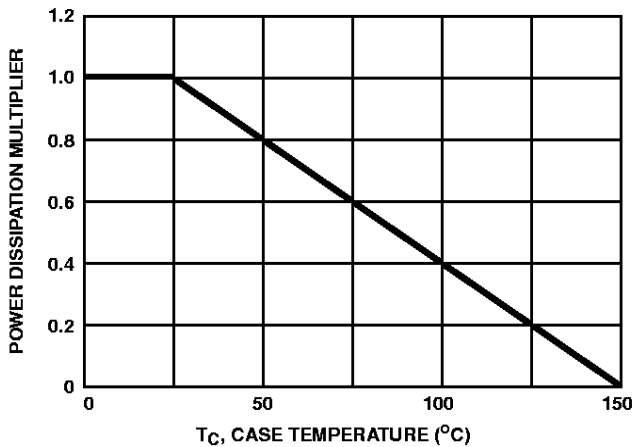

FIGURE 1. NORMALIZED POWER DISSIPATION vs CASE TEMPERATURE

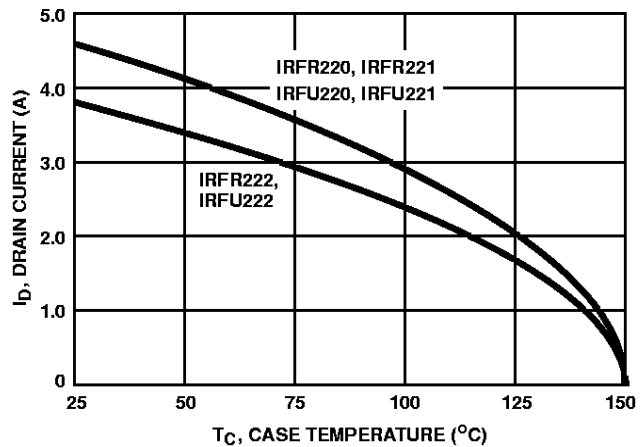

FIGURE 2. MAXIMUM CONTINUOUS DRAIN CURRENT vs CASE TEMPERATURE

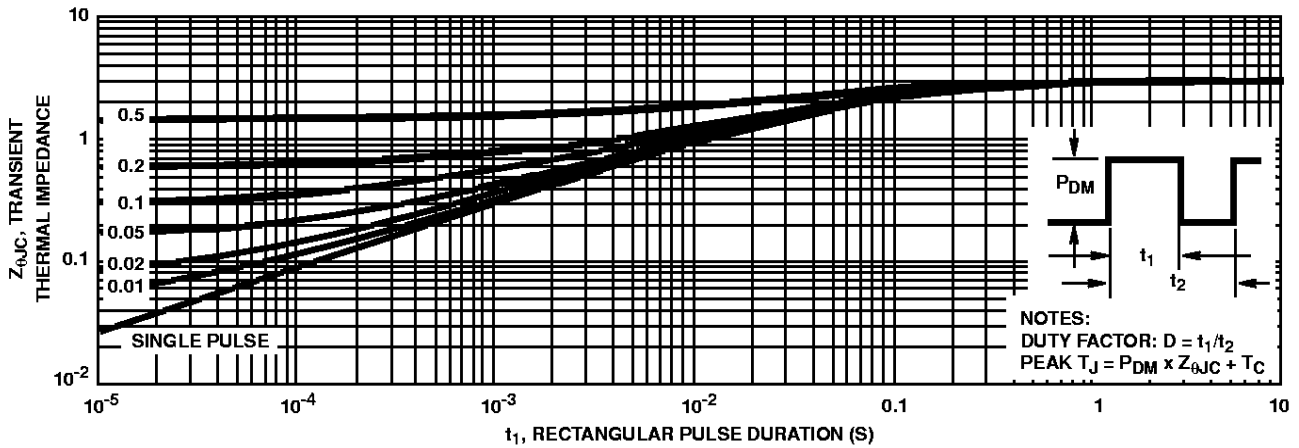

FIGURE 3. MAXIMUM TRANSIENT THERMAL IMPEDANCE

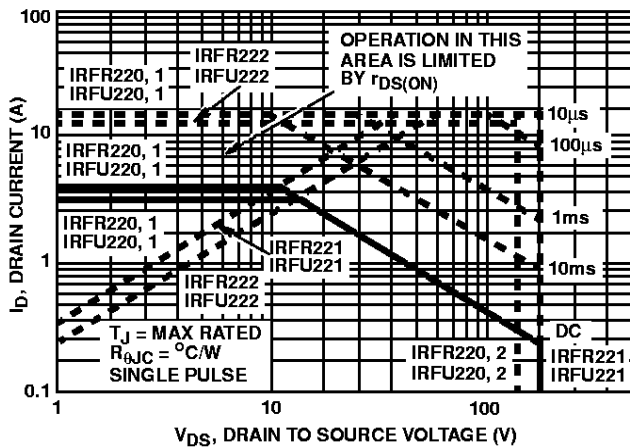

FIGURE 4. FORWARD BIAS SAFE OPERATING AREA

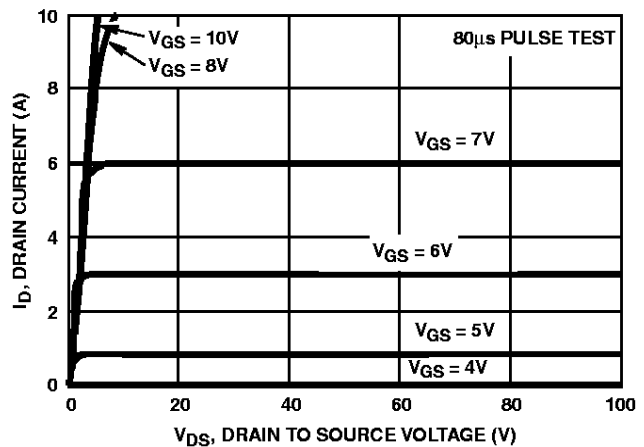

FIGURE 5. OUTPUT CHARACTERISTICS

Typical Performance Curves Unless Otherwise Specified (Continued)

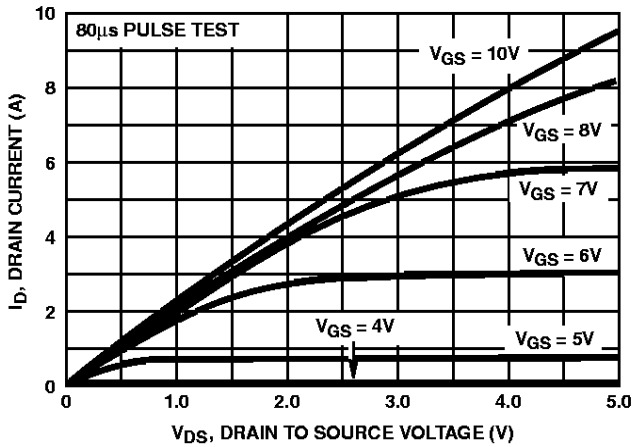

FIGURE 6. SATURATION CHARACTERISTICS

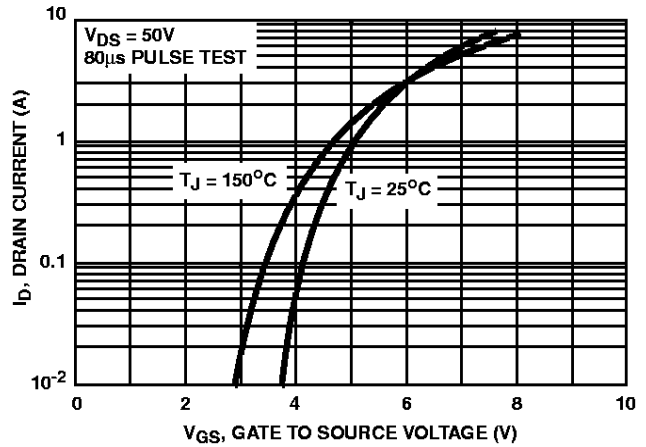

FIGURE 7. TRANSFER CHARACTERISTICS

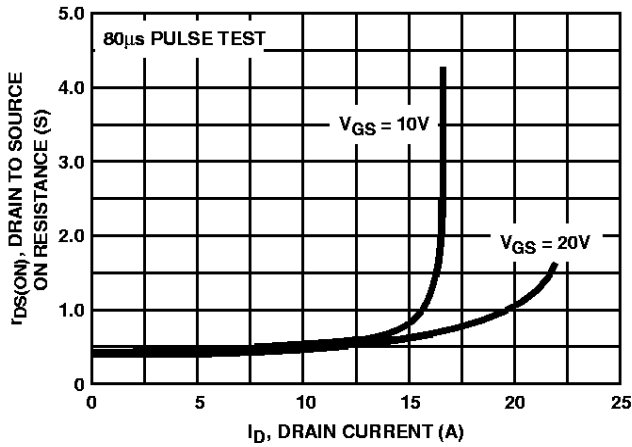

FIGURE 8. DRAIN TO SOURCE ON RESISTANCE vs GATE VOLTAGE AND DRAIN CURRENT

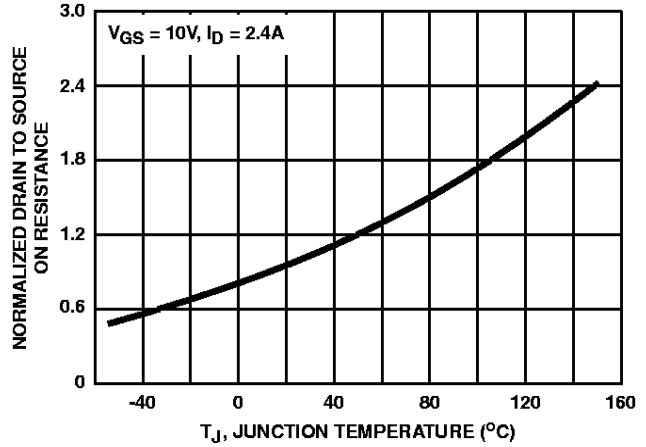

FIGURE 9. NORMALIZED DRAIN TO SOURCE ON RESISTANCE vs JUNCTION TEMPERATURE

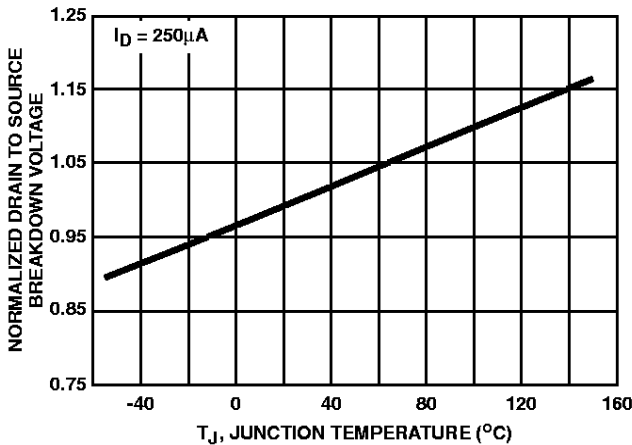

FIGURE 10. NORMALIZED DRAIN TO SOURCE BREAKDOWN VOLTAGE vs JUNCTION TEMPERATURE

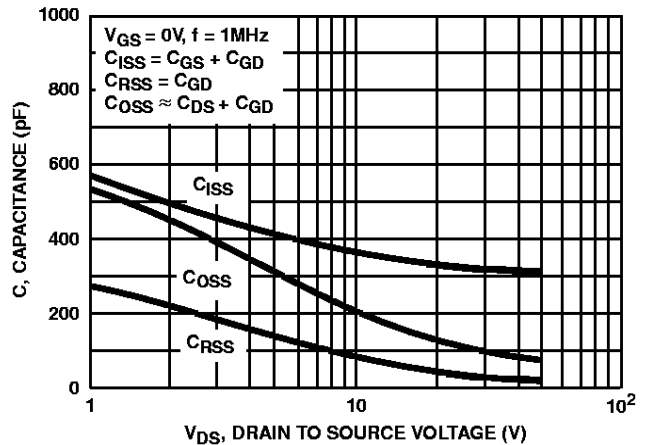

FIGURE 11. CAPACITANCE vs DRAIN TO SOURCE VOLTAGE

Typical Performance Curves Unless Otherwise Specified (Continued)

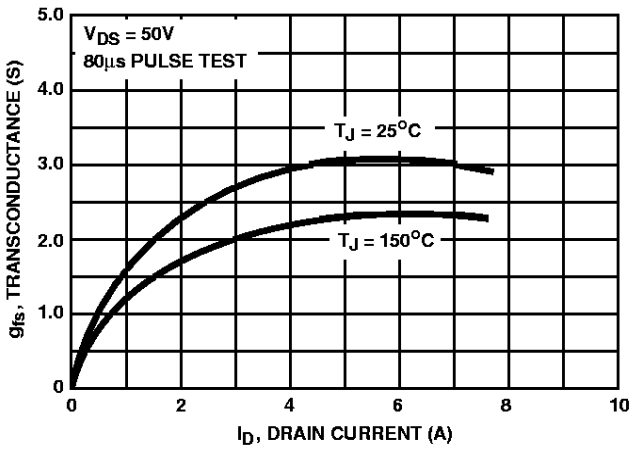

FIGURE 12. TRANSCONDUCTANCE vs DRAIN CURRENT

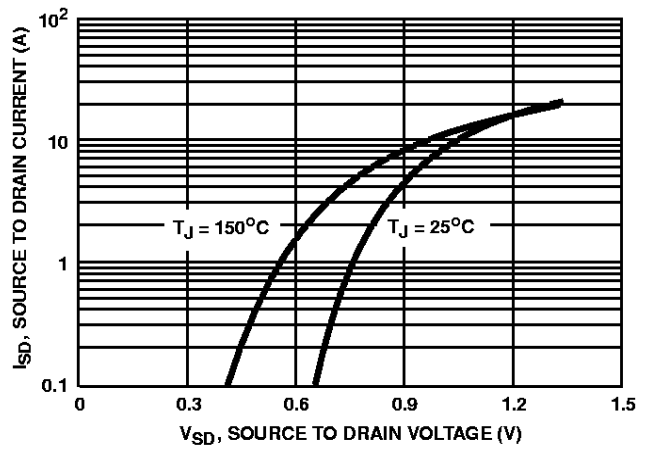

FIGURE 13. SOURCE TO DRAIN DIODE VOLTAGE

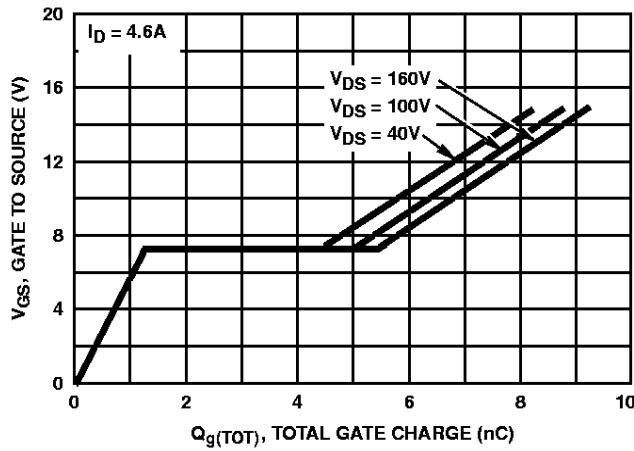

FIGURE 14. GATE TO SOURCE VOLTAGE vs GATE CHARGE

Test Circuits and Waveforms

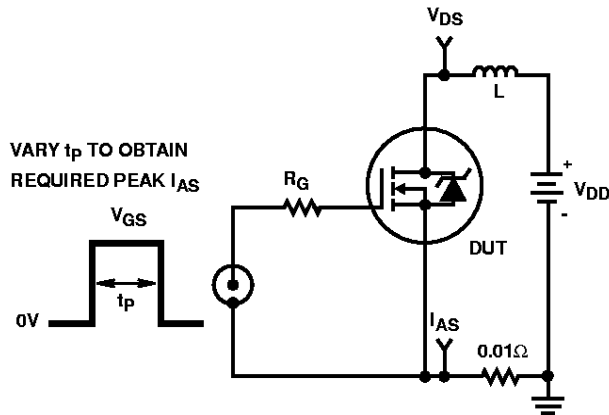

FIGURE 15. UNCLAMPED ENERGY TEST CIRCUIT

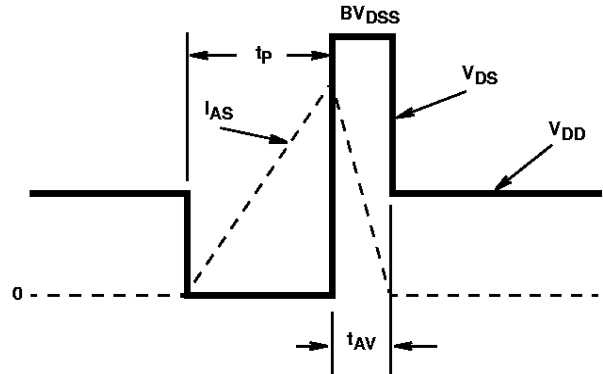

FIGURE 16. UNCLAMPED ENERGY WAVEFORMS

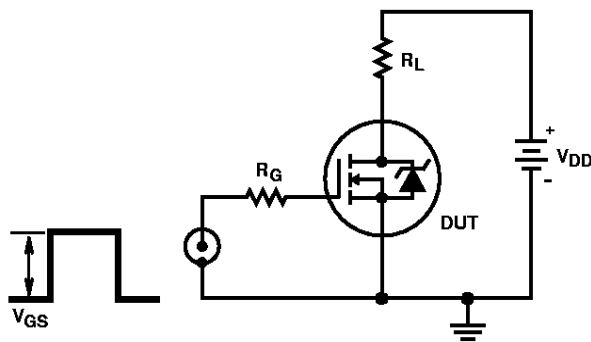

FIGURE 17. SWITCHING TIME TEST CIRCUIT

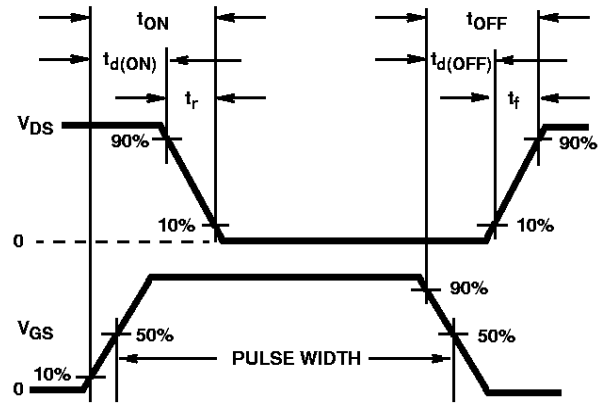

FIGURE 18. RESISTIVE SWITCHING WAVEFORMS

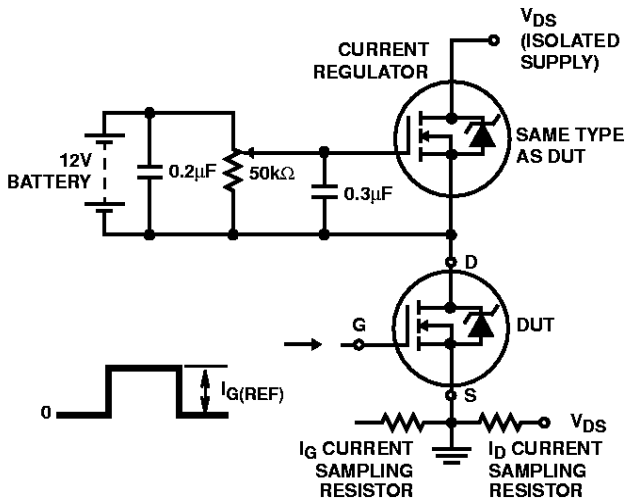

FIGURE 19. GATE CHARGE TEST CIRCUIT

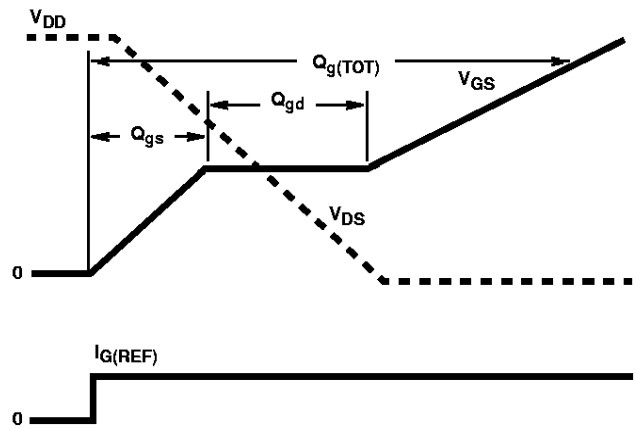

FIGURE 20. GATE CHARGE WAVEFORMS