

## N-Channel Enhancement Mode Power MOSFET

### Description

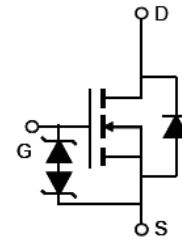
The RM3416 uses advanced trench technology to provide excellent  $R_{DS(ON)}$ , low gate charge and operation with gate voltages as low as 1.8V. This device is suitable for use as a load switch or in PWM applications. It is ESD protected.

### General Features

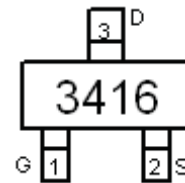
- $V_{DS} = 20V, I_D = 6.5A$ 
  - $R_{DS(ON)} < 40m\Omega @ V_{GS} = 1.8V$
  - $R_{DS(ON)} < 33m\Omega @ V_{GS} = 2.5V$
  - $R_{DS(ON)} < 27m\Omega @ V_{GS} = 4.5V$
- ESD Rating: 2000V HBM
- High Power and current handling capability
- Lead free product is acquired
- Surface mount package

### Application

- PWM application
- Load switch



Schematic diagram



Marking and pin assignment



SOT-23 top view

### Package Marking and Ordering Information

Device Marking	Device	Device Package	Reel Size	Tape width	Quantity
3416	RM3416	SOT-23	Ø180mm	8mm	3000 units

### Absolute Maximum Ratings ( $T_A = 25^\circ C$ unless otherwise noted)

Parameter	Symbol	Limit	Unit
Drain-Source Voltage	$V_{DS}$	20	V
Gate-Source Voltage	$V_{GS}$	$\pm 12$	V
Drain Current-Continuous	$I_D$	6.5	A
Drain Current-Pulsed <sup>(Note 1)</sup>	$I_{DM}$	30	A
Maximum Power Dissipation	$P_D$	1.4	W
Operating Junction and Storage Temperature Range	$T_J, T_{STG}$	-55 To 150	$^\circ C$

### Thermal Characteristic

Thermal Resistance, Junction-to-Ambient <sup>(Note 2)</sup>	$R_{\theta JA}$	89	$^\circ C/W$
---	-----------------	----	--------------

### Electrical Characteristics ( $T_A = 25^\circ C$ unless otherwise noted)

Parameter	Symbol	Condition	Min	Typ	Max	Unit
<b>Off Characteristics</b>						
Drain-Source Breakdown Voltage	$BV_{DSS}$	$V_{GS} = 0V, I_D = 250\mu A$	20		-	V

Zero Gate Voltage Drain Current	$I_{DSS}$	$V_{DS}=20V, V_{GS}=0V$	-	-	1	$\mu A$
Gate-Body Leakage Current	$I_{GSS}$	$V_{GS}=\pm 10V, V_{DS}=0V$	-	-	$\pm 10$	$\mu A$
<b>On Characteristics</b> <sup>(Note 3)</sup>						
Gate Threshold Voltage	$V_{GS(th)}$	$V_{DS}=V_{GS}, I_D=250\mu A$	0.45	0.7	1.0	V
Drain-Source On-State Resistance	$R_{DS(on)}$	$V_{GS}=4.5V, I_D=6.5A$	-	17	27	$m\Omega$
		$V_{GS}=2.5V, I_D=5.5A$	-	21	33	$m\Omega$
		$V_{GS}=1.8V, I_D=5A$	-	28	40	$m\Omega$
Forward Transconductance	$g_{FS}$	$V_{DS}=5V, I_D=6.5A$	8	-	-	S
<b>Dynamic Characteristics</b> <sup>(Note 4)</sup>						
Input Capacitance	$C_{iss}$	$V_{DS}=10V, V_{GS}=0V,$ $F=1.0MHz$	-	660	-	PF
Output Capacitance	$C_{oss}$		-	160	-	PF
Reverse Transfer Capacitance	$C_{rss}$		-	87	-	PF
<b>Switching Characteristics</b> <sup>(Note 4)</sup>						
Turn-on Delay Time	$t_{d(on)}$	$V_{DD}=10V, R_L=1.5\Omega$ $V_{GS}=5V, R_{GEN}=3\Omega$	-	0.5		nS
Turn-on Rise Time	$t_r$		-	1		nS
Turn-Off Delay Time	$t_{d(off)}$		-	12		nS
Turn-Off Fall Time	$t_f$		-	4		nS
Total Gate Charge	$Q_g$	$V_{DS}=10V, I_D=6.5A,$ $V_{GS}=4.5V$	-	8		nC
Gate-Source Charge	$Q_{gs}$		-	2.5	-	nC
Gate-Drain Charge	$Q_{gd}$		-	3	-	nC
<b>Drain-Source Diode Characteristics</b>						
Diode Forward Voltage <sup>(Note 3)</sup>	$V_{SD}$	$V_{GS}=0V, I_S=6.5A$	-	-	1.2	V
Diode Forward Current <sup>(Note 2)</sup>	$I_S$		-	-	6.5	A

### Notes:

1. Repetitive Rating: Pulse width limited by maximum junction temperature.
2. Surface Mounted on FR4 Board,  $t \leq 10$  sec.
3. Pulse Test: Pulse Width  $\leq 300\mu s$ , Duty Cycle  $\leq 2\%$ .
4. Guaranteed by design, not subject to production

## RATING AND CHARACTERISTICS CURVES (RM3416)

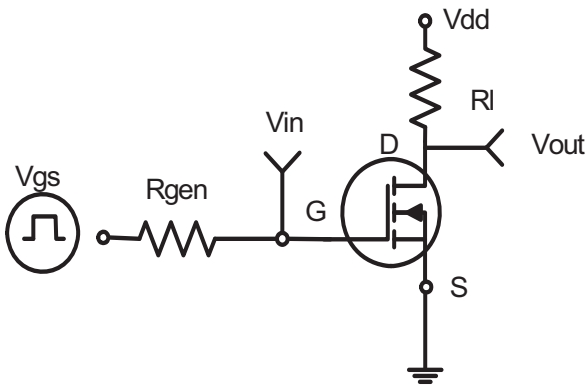


Figure 1: Switching Test Circuit

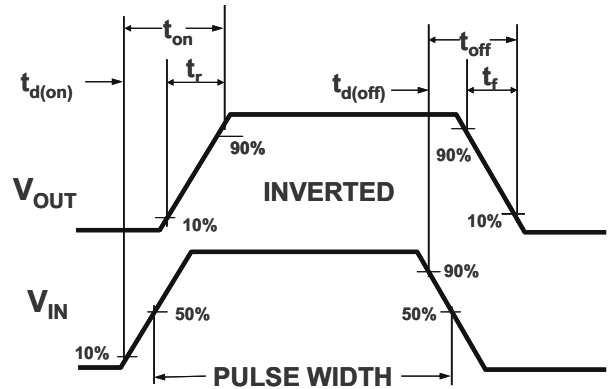


Figure 2: Switching Waveforms

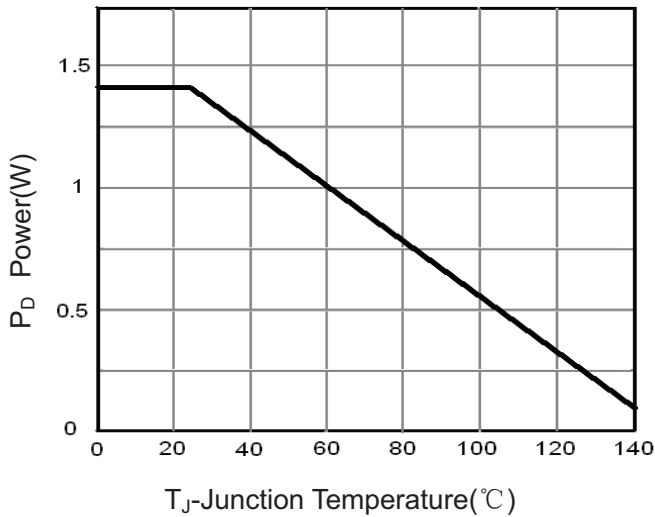


Figure 3 Power Dissipation

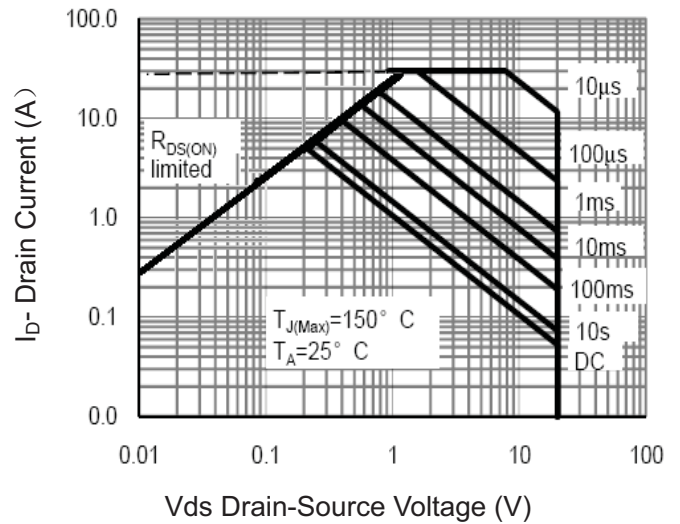


Figure 4 Safe Operation Area

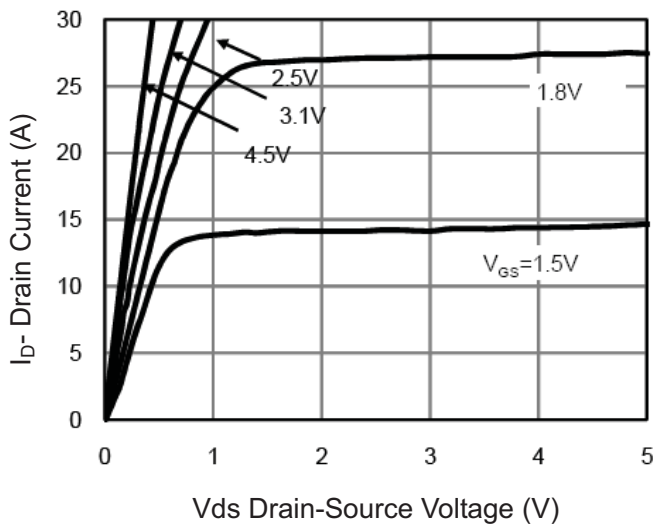


Figure 5 Output Characteristics

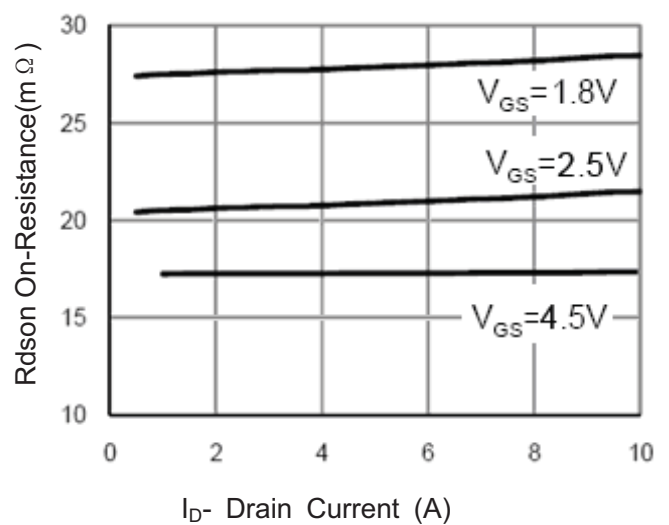
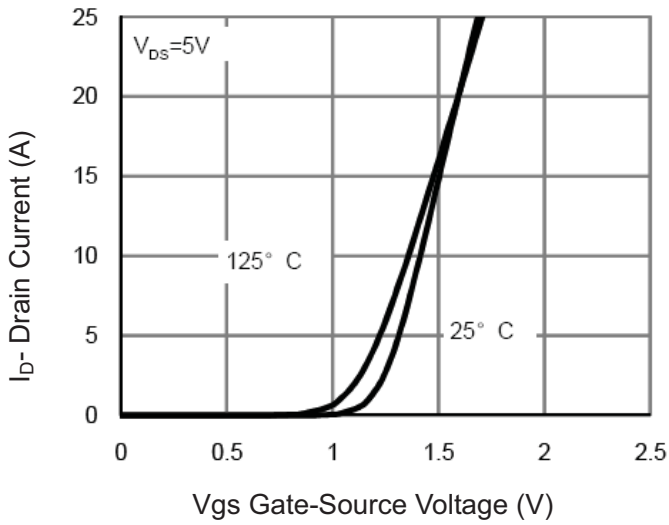
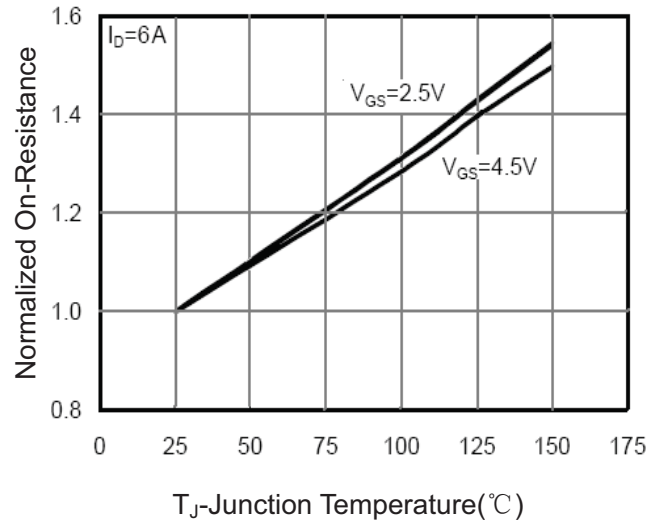


Figure 6 Drain-Source On-Resistance

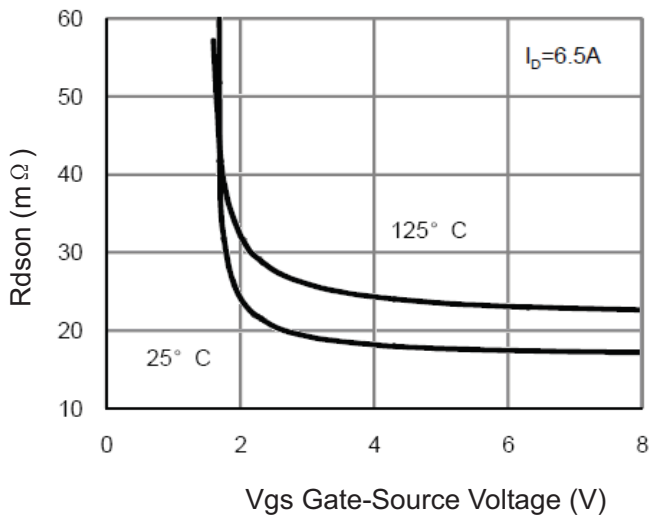
## RATING AND CHARACTERISTICS CURVES (RM3416)



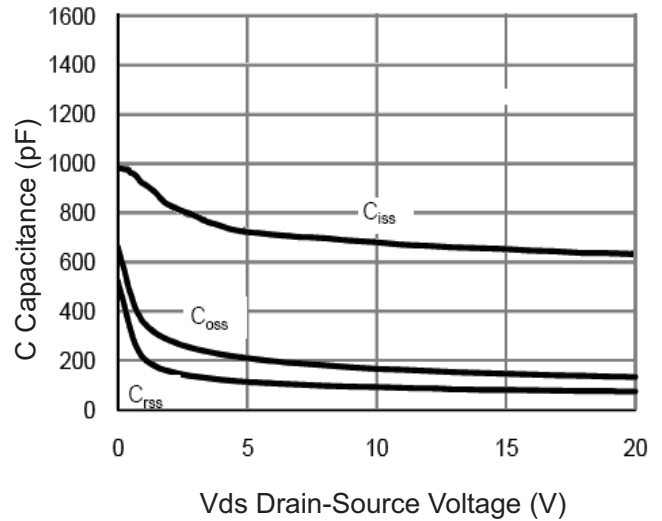
**Figure 7 Transfer Characteristics**



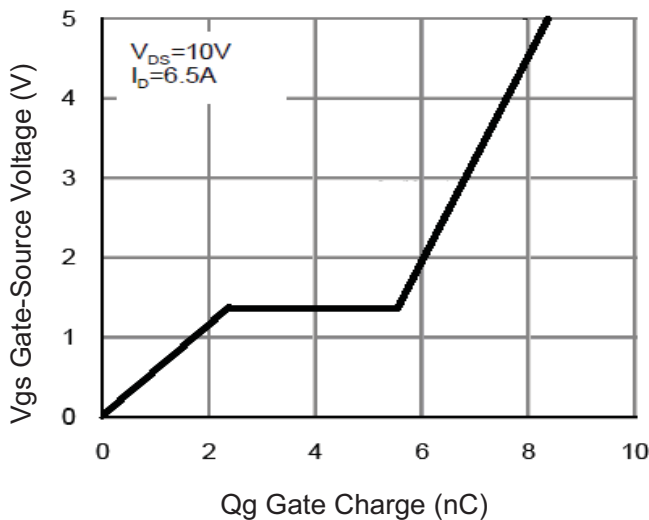
**Figure 8 Drain-Source On-Resistance**



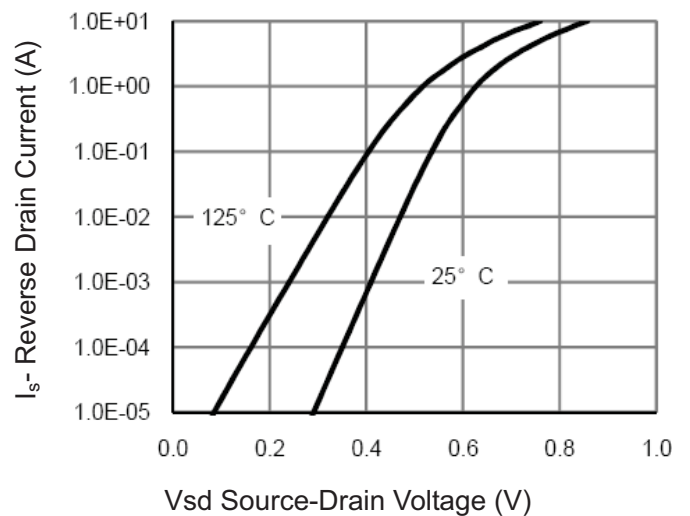
**Figure 9 Rdson vs Vgs**



**Figure 10 Capacitance vs Vds**

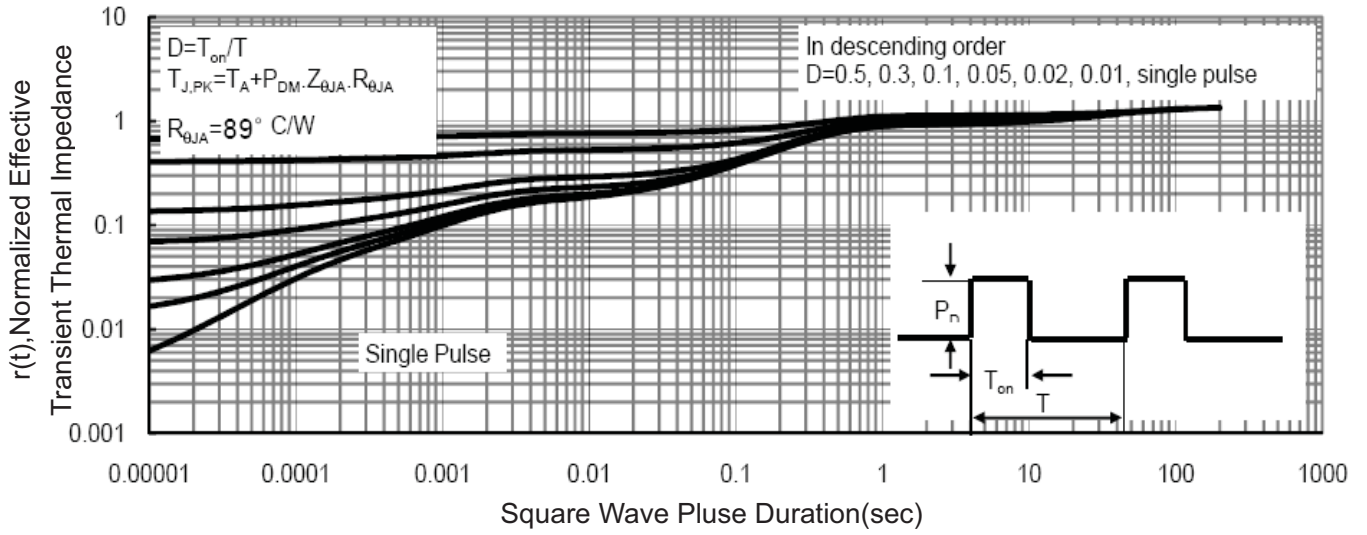


**Figure 11 Gate Charge**



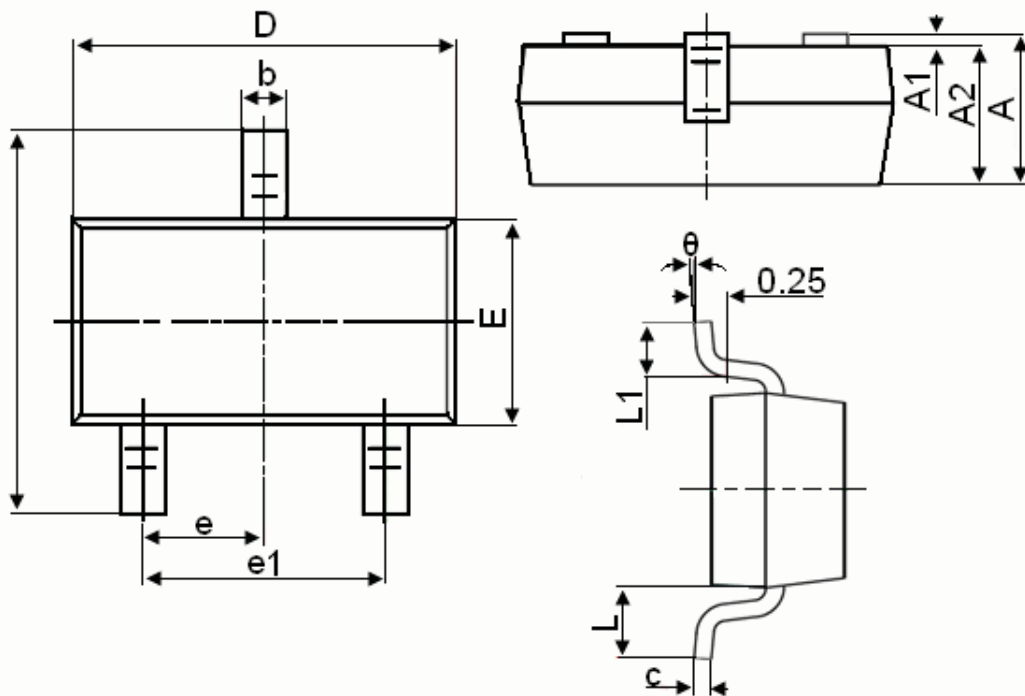
**Figure 12 Source- Drain Diode Forward**

## RATING AND CHARACTERISTICS CURVES (RM3416)



**Figure 13 Normalized Maximum Transient Thermal Impedance**

## SOT-23 Package Information



Symbol	Dimensions in Millimeters	
	MIN.	MAX.
A	0.900	1.150
A1	0.000	0.100
A2	0.900	1.050
b	0.300	0.500
c	0.080	0.150
D	2.800	3.000
E	1.200	1.400
E1	2.250	2.550
e	0.950TYP	
e1	1.800	2.000
L	0.550REF	
L1	0.300	0.500
θ	0°	8°

### Notes

1. All dimensions are in millimeters.
2. Tolerance  $\pm 0.10\text{mm}$  (4 mil) unless otherwise specified
3. Package body sizes exclude mold flash and gate burrs. Mold flash at the non-lead sides should be less than 5 mils.
4. Dimension L is measured in gauge plane.
5. Controlling dimension is millimeter, converted inch dimensions are not necessarily exact.

## DISCLAIMER NOTICE

Rectron Inc reserves the right to make changes without notice to any product specification herein, to make corrections, modifications, enhancements or other changes. Rectron Inc or anyone on its behalf assumes no responsibility or liability for any errors or inaccuracies. Data sheet specifications and its information contained are intended to provide a product description only. "Typical" parameters which may be included on RECTRON data sheets and/ or specifications can and do vary in different applications and actual performance may vary over time. Rectron Inc does not assume any liability arising out of the application or use of any product or circuit.

Rectron products are not designed, intended or authorized for use in medical, life-saving implant or other applications intended for life-sustaining or other related applications where a failure or malfunction of component or circuitry may directly or indirectly cause injury or threaten a life without expressed written approval of Rectron Inc. Customers using or selling Rectron components for use in such applications do so at their own risk and shall agree to fully indemnify Rectron Inc and its subsidiaries harmless against all claims, damages and expenditures.